



US00D577086S

(12) **United States Design Patent**
Nicolette et al.

(10) **Patent No.:** **US D577,086 S**
(45) **Date of Patent:** **** Sep. 16, 2008**

(54) **GOLF PUTTER HEAD**

D566,211 S * 4/2008 Cameron D21/736

(75) Inventors: **Michael R. Nicolette**, Scottsdale, AZ (US); **Bradley D. Schweigert**, Anthem, AZ (US); **David D. Jones**, Glendale, AZ (US); **Marty R. Jertson**, Cave Creek, AZ (US)

* cited by examiner

Primary Examiner—Mitchell I Siegel

(73) Assignee: **Karsten Manufacturing Corporation**, Phoenix, AZ (US)

(57) **CLAIM**

The ornamental design for a golf putter head, as shown and described.

(**) Term: **14 Years**

DESCRIPTION

(21) Appl. No.: **29/283,495**

FIG. 1 is a top perspective view of an example golf putter head;

(22) Filed: **Aug. 15, 2007**

FIG. 2 is a bottom perspective view of the golf putter head of FIG. 1;

(51) **LOC (8) Cl.** **21-02**

(52) **U.S. Cl.** **D21/743**

(58) **Field of Classification Search** D21/736-746;
473/324-331, 340-341, 251-256

FIG. 3 is a front elevational view of the golf putter head of FIG. 1;

See application file for complete search history.

FIG. 4 is a rear elevational view of the golf putter head of FIG. 1;

(56) **References Cited**

U.S. PATENT DOCUMENTS

D394,690 S *	5/1998	Sheets	D21/743
D404,451 S *	1/1999	Sheets	D21/746
D463,517 S *	9/2002	Ngon	D21/736
D551,727 S *	9/2007	Sizemore, Jr.	D21/736
D552,195 S *	10/2007	Sizemore, Jr.	D21/736
D559,929 S *	1/2008	Cameron	D21/736
D565,579 S *	4/2008	Gunn et al.	D14/485

FIG. 5 is a top view of the golf putter head of FIG. 1;

FIG. 6 is a bottom view of the golf putter head of FIG. 1;

FIG. 7 is a heel end view of the golf putter head of FIG. 1; and,

FIG. 8 is a toe end view of the golf putter head of FIG. 1.

The broken lines shown in FIGS. 1, 2, 3, 4, 5, 6, 7, and 8 are for illustrative purposes only and form no part of the claimed design.

1 Claim, 4 Drawing Sheets

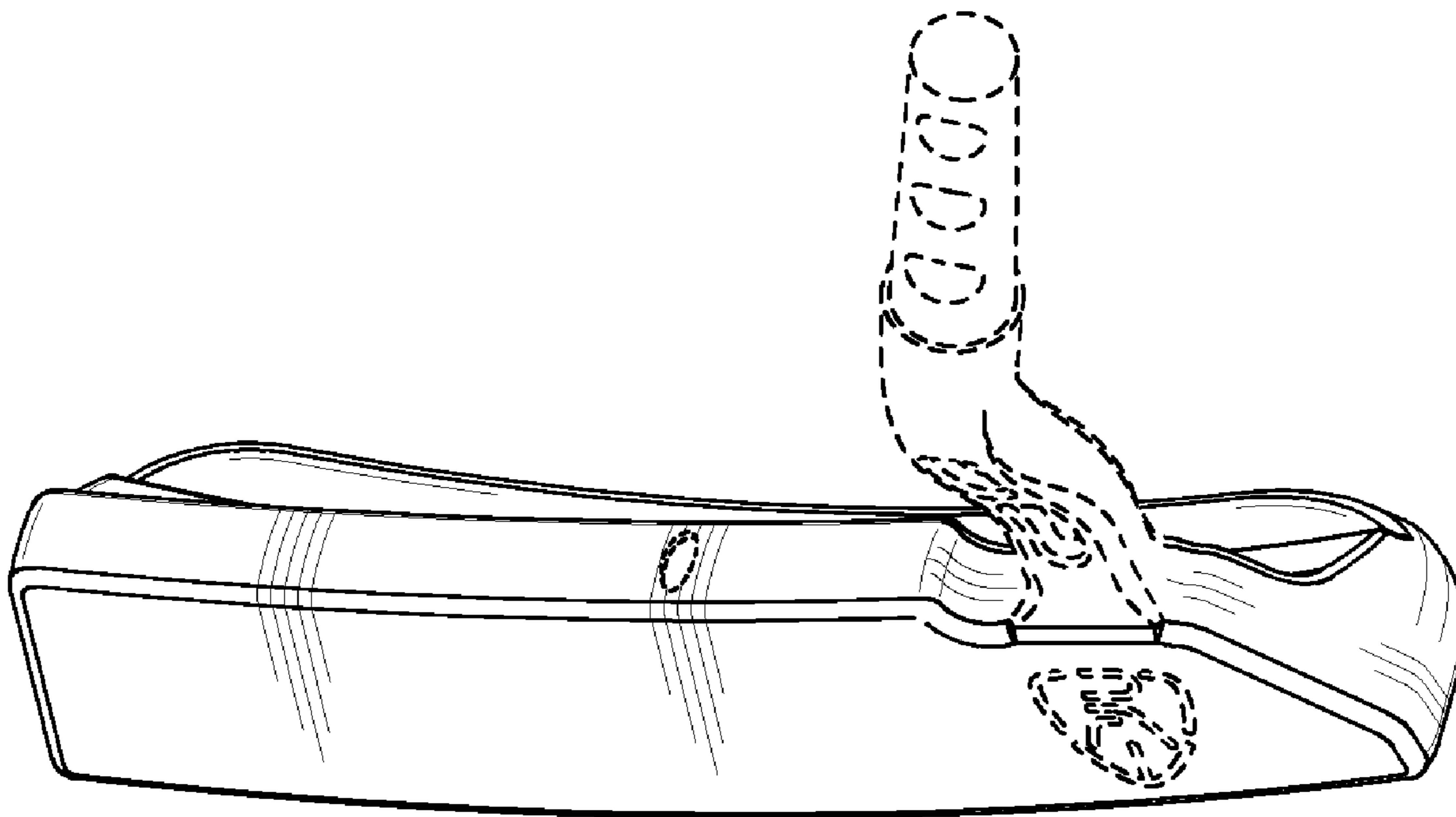

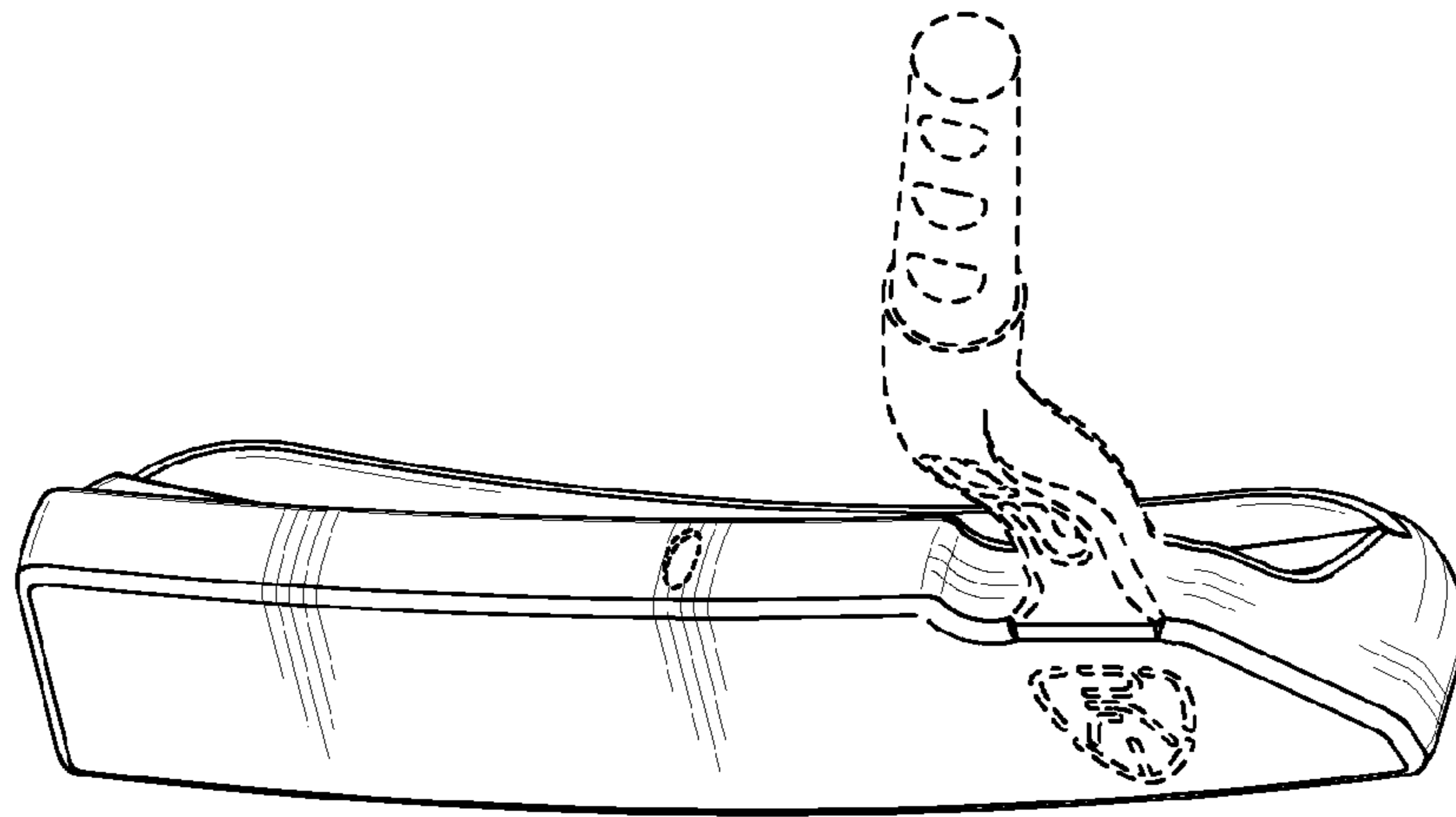

FIG. 1

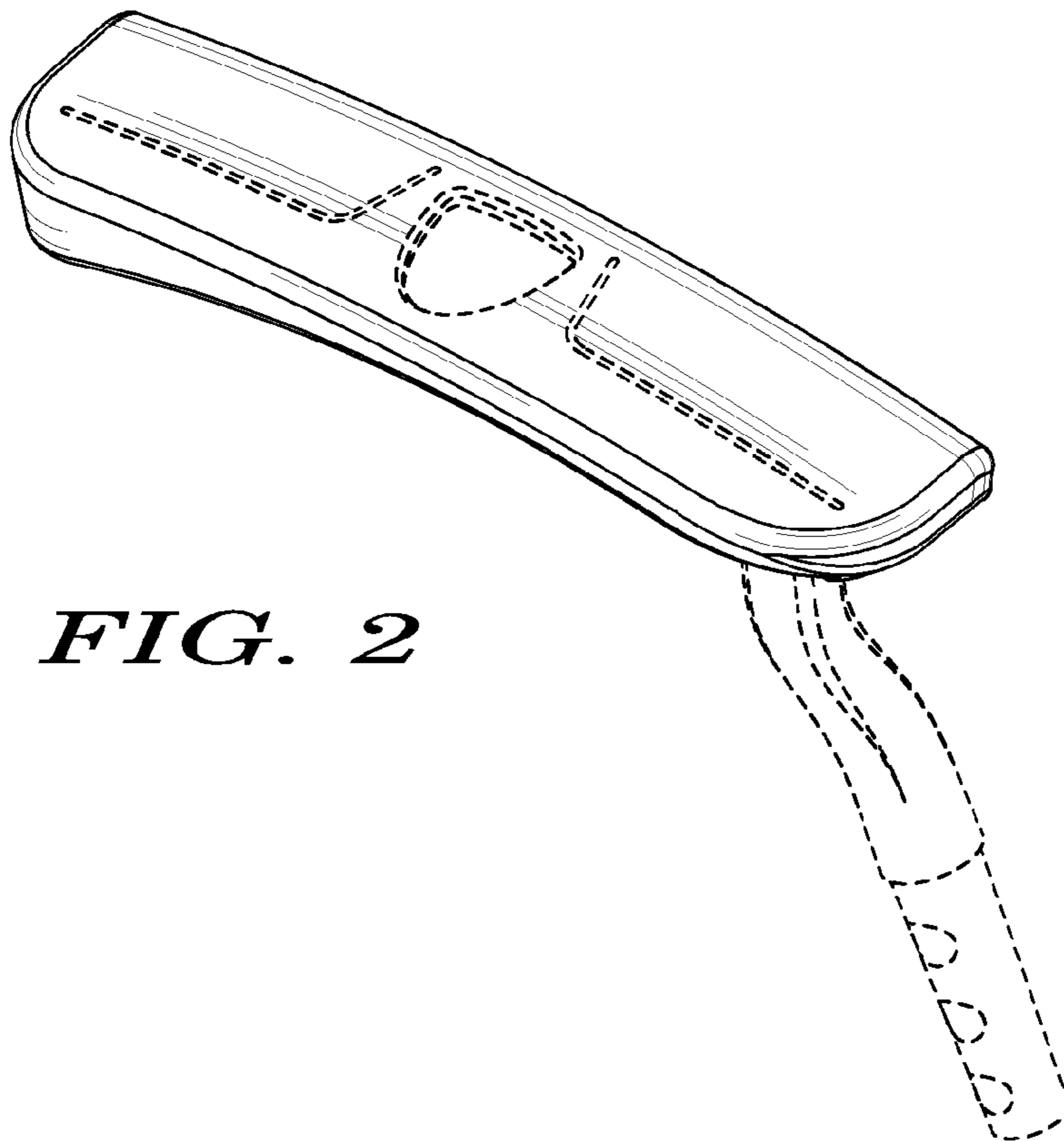

FIG. 2

FIG. 3

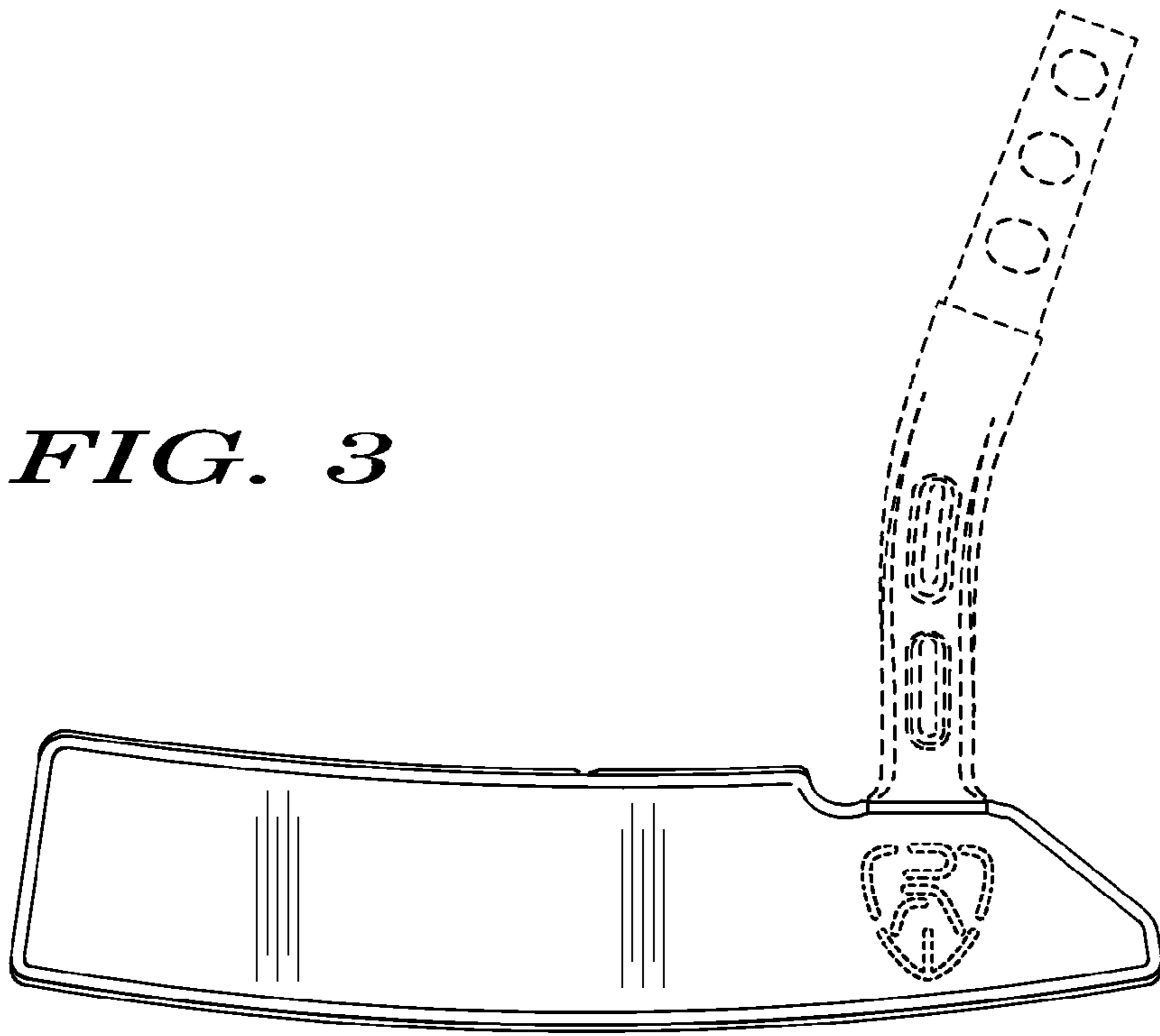
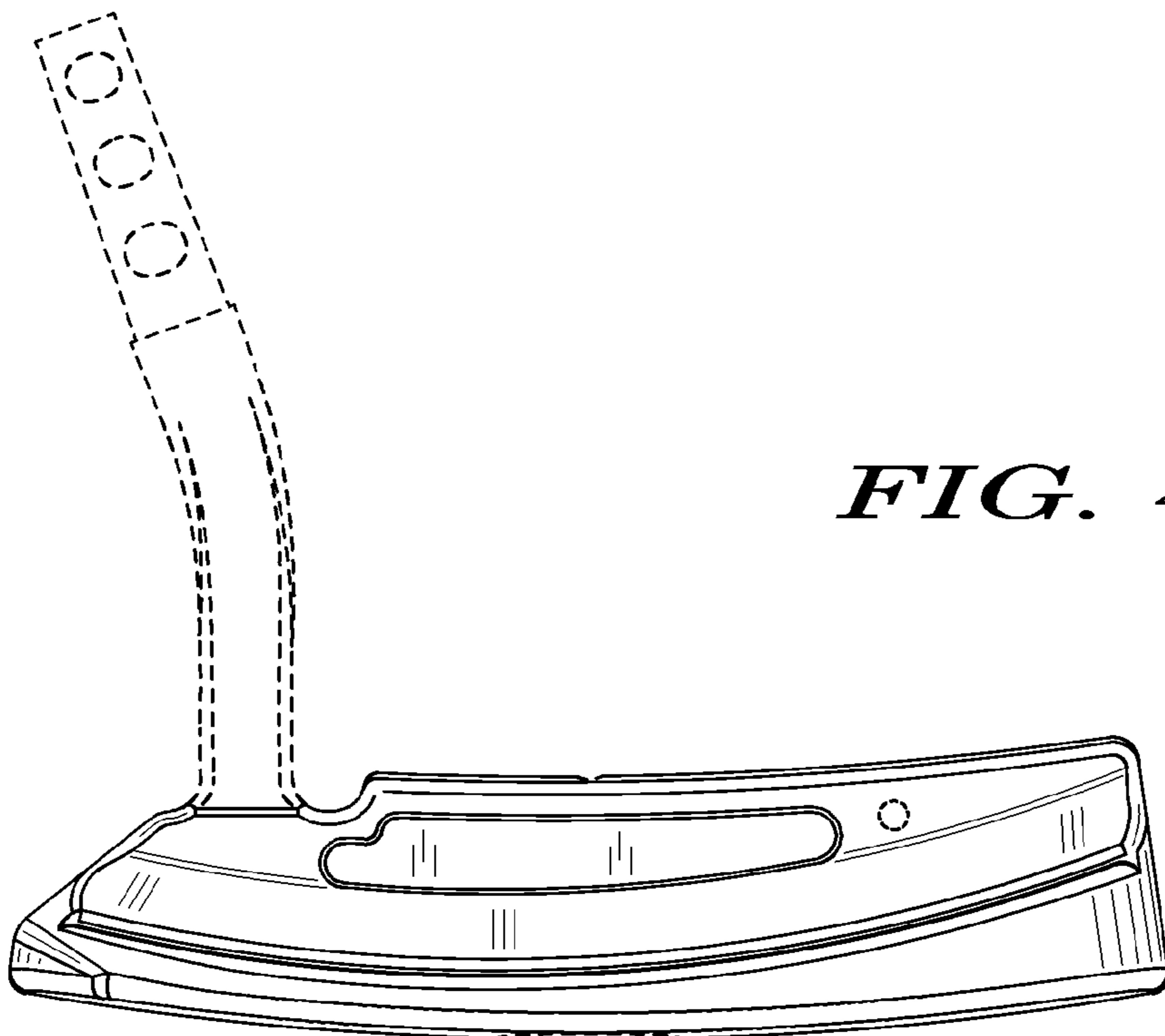

FIG. 4



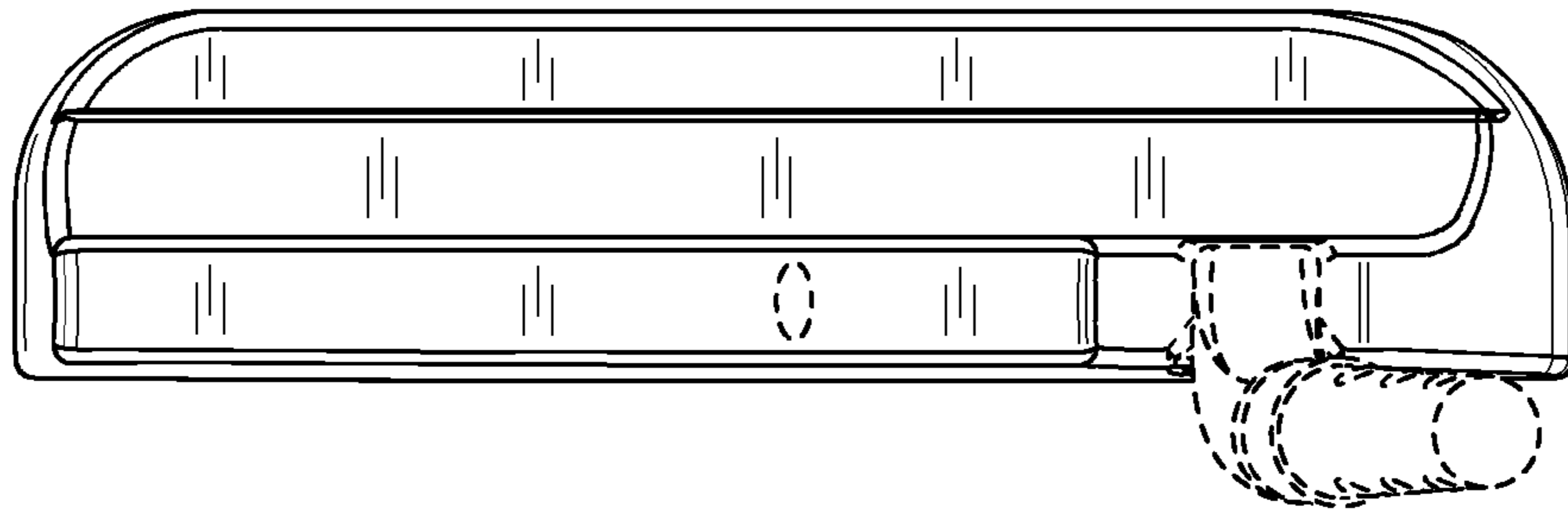

FIG. 5

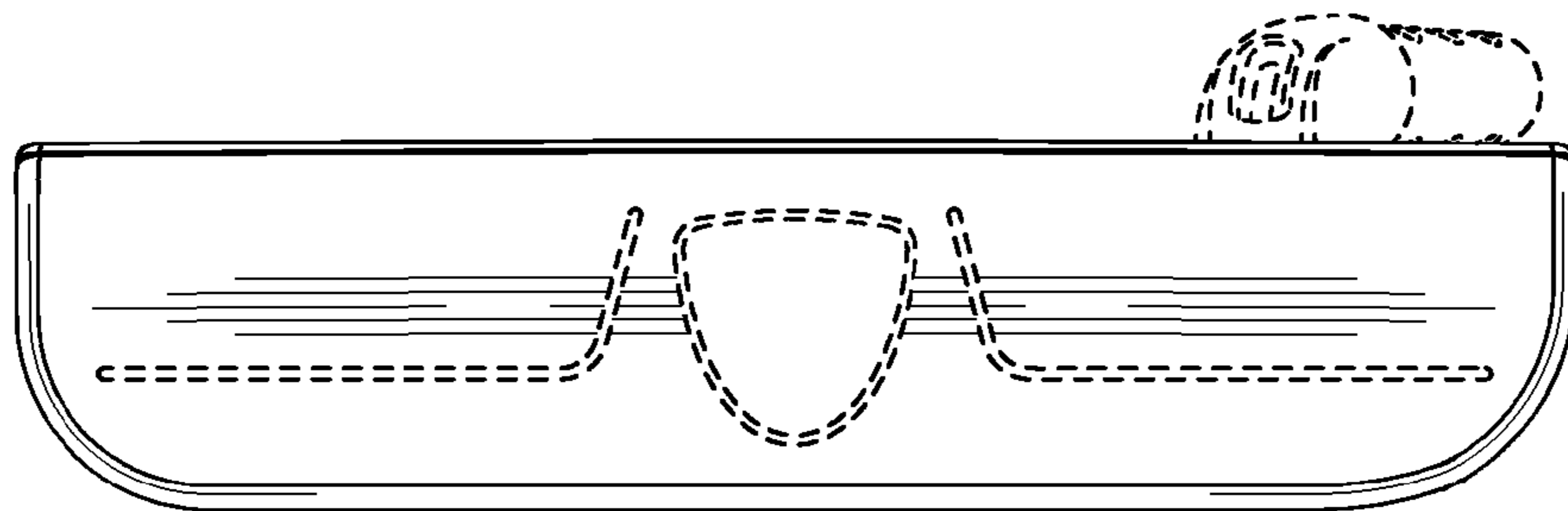

FIG. 6

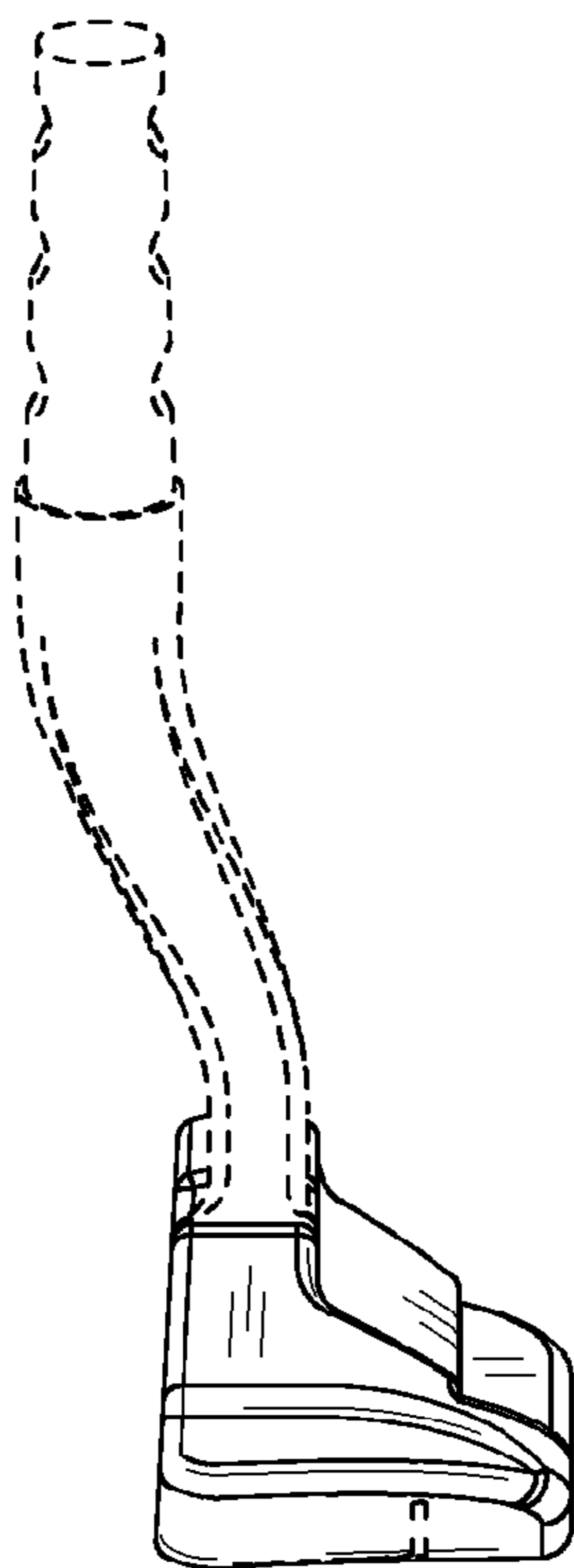

FIG. 7



FIG. 8