



US00D577073S

(12) **United States Design Patent**  
**Fox**

(10) **Patent No.:** **US D577,073 S**

(45) **Date of Patent:** **\*\* Sep. 16, 2008**

(54) **PEN**

(76) **Inventor:** **Billy Fox**, 342 Shelbyville Mills Rd.,  
Shelbyville, TN (US) 37160

(\*\*) **Term:** **14 Years**

(21) **Appl. No.:** **29/280,734**

(22) **Filed:** **Jun. 5, 2007**

(51) **LOC (8) Cl.** ..... **19-06**

(52) **U.S. Cl.** ..... **D19/54**

(58) **Field of Classification Search** ..... D19/35,  
D19/36, 41, 42, 43, 44, 45, 46, 47, 48, 49,  
D19/50, 51, 54, 55, 56, 57; D27/146; 24/11 R,  
24/11 F, 11 P; 40/334; 401/6, 52, 99, 100,  
401/104, 105, 106, 107, 108, 109, 192, 195,  
401/243, 244, 245, 246, 247; 362/118  
See application file for complete search history.

(56) **References Cited**

**U.S. PATENT DOCUMENTS**

- D83,181 S \* 1/1931 Stevenson ..... D27/146
- D226,335 S \* 2/1973 Levy et al. .... D19/77
- D247,570 S \* 3/1978 McLeod ..... D19/77
- D415,198 S \* 10/1999 Mouawad ..... D19/48
- D424,110 S \* 5/2000 Hu ..... D19/51
- D442,225 S \* 5/2001 Lewis, Jr. .... D19/47
- D444,815 S \* 7/2001 Izushima ..... D19/51
- D446,242 S \* 8/2001 Stukenkemper ..... D19/43
- D451,137 S \* 11/2001 Reichmann ..... D19/36
- D457,186 S \* 5/2002 Moon ..... D19/43
- D457,563 S \* 5/2002 Moon ..... D19/48
- D460,112 S \* 7/2002 Keda ..... D19/51
- D470,530 S \* 2/2003 Moon ..... D19/55
- D476,685 S \* 7/2003 Metaxatos et al. .... D19/51
- D479,603 S \* 9/2003 Tyce ..... D24/114
- D487,774 S \* 3/2004 Keda ..... D19/51
- D488,188 S \* 4/2004 Keda ..... D19/51

- D497,951 S \* 11/2004 Morton et al. .... D19/50
- D501,881 S \* 2/2005 Shimizu ..... D19/43
- D507,301 S \* 7/2005 Qiu ..... D19/51
- D508,950 S \* 8/2005 Kiple et al. .... D19/50
- D539,346 S \* 3/2007 Song ..... D19/43
- D558,268 S \* 12/2007 Siegel ..... D19/47

**FOREIGN PATENT DOCUMENTS**

GB 3016847 \* 7/2004

**OTHER PUBLICATIONS**

Big EZ Promotional Retractable Pen, #6967, as shown on www.pens.com, viewed Apr. 30, 2008 (3 pages).\*

Papermate Gel Roller RT2 Opaque, as shown on www.4imprint.com, dated Sep. 2006, (4 pages).\*

\* cited by examiner

*Primary Examiner*—Elizabeth A. Albert

*Assistant Examiner*—Karen E Eldridge Powers

(74) *Attorney, Agent, or Firm*—Foley & Lardner LLP

(57) **CLAIM**

The ornamental design for a pen, as shown and described.

**DESCRIPTION**

FIG. 1. is a top perspective view of the pen;

FIG. 2. is a top view of the pen;

FIG. 3. is a bottom view of the pen;

FIG. 4. is a left side view of the pen;

FIG. 5. is a right side view of the pen;

FIG. 6. is an front end view of the pen; and,

FIG. 7. is a rear end view of the pen.

The portions of the pen shown in broken lines illustrate environmental matter and form no part of the claimed design.

**1 Claim, 4 Drawing Sheets**

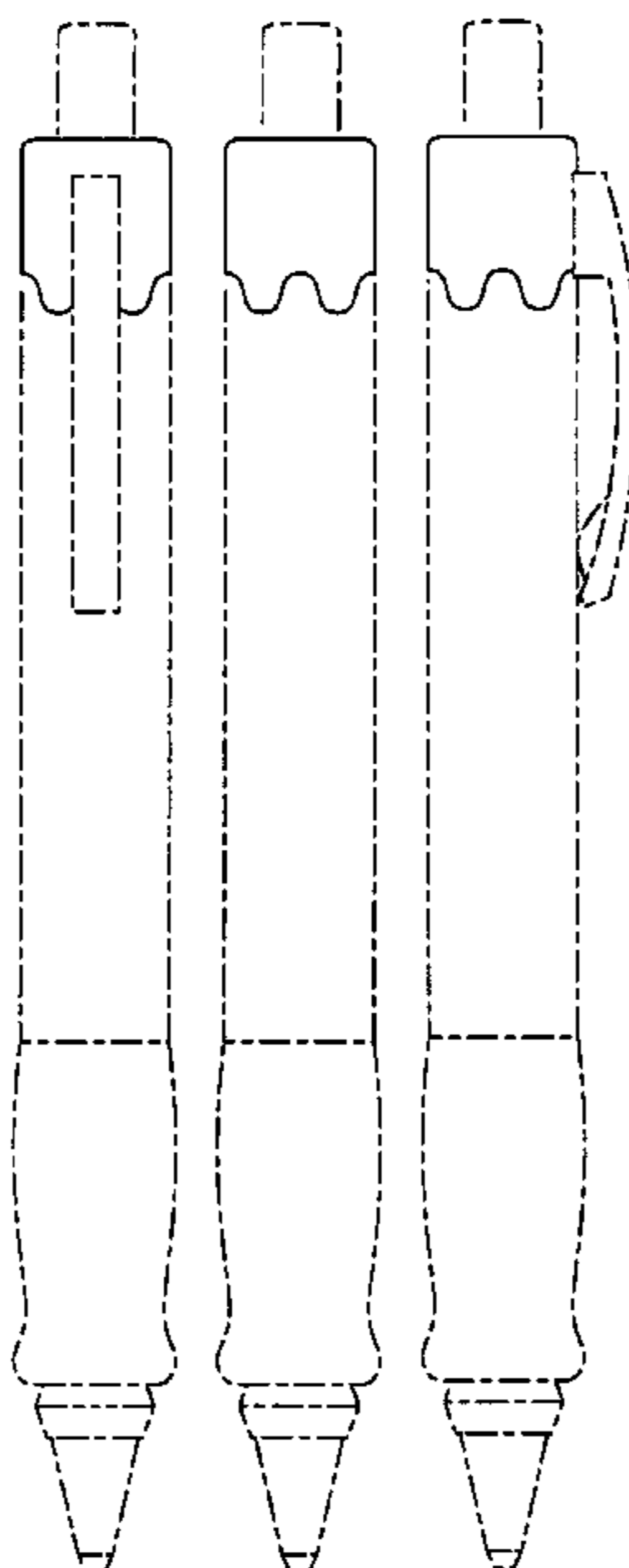

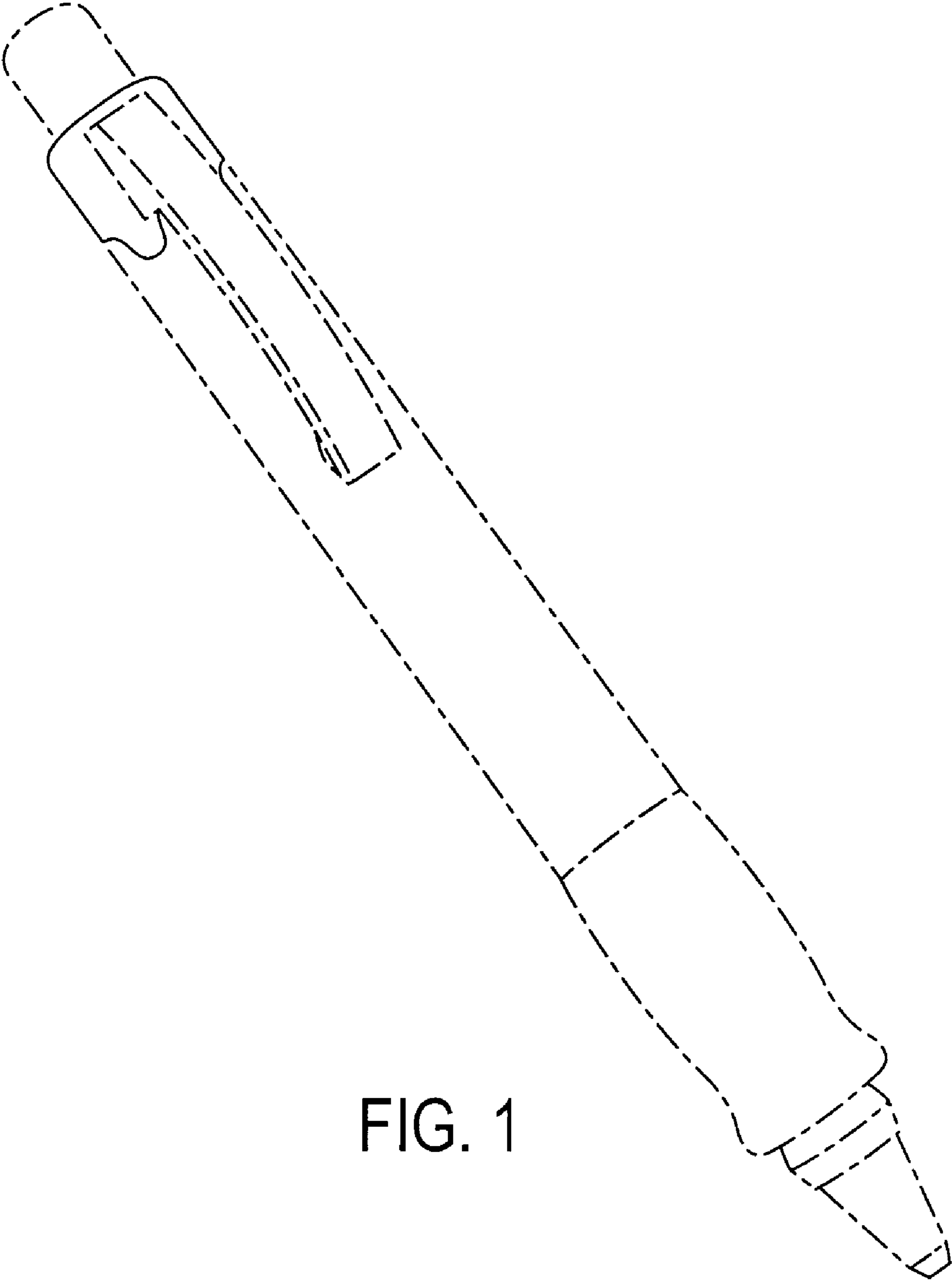

FIG. 1

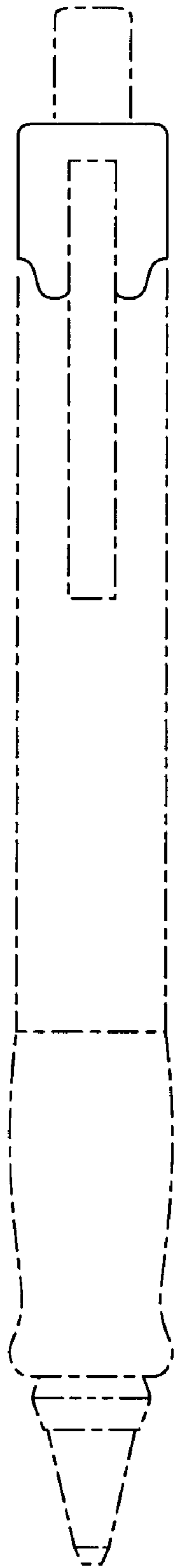

FIG. 2



FIG. 3

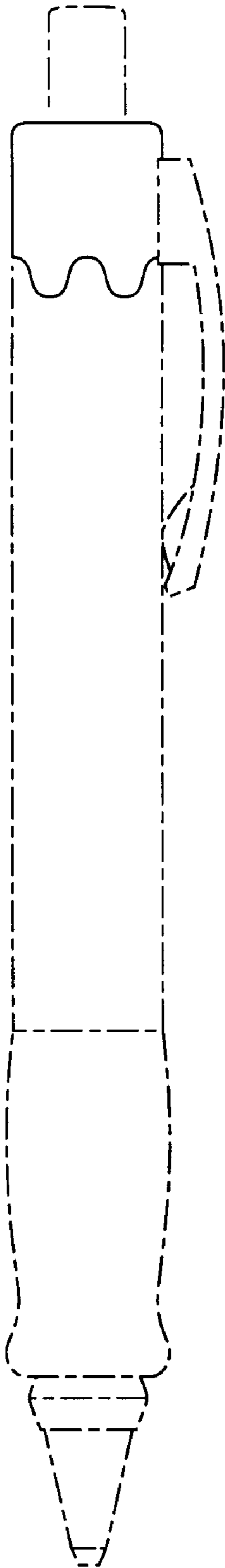

FIG. 4

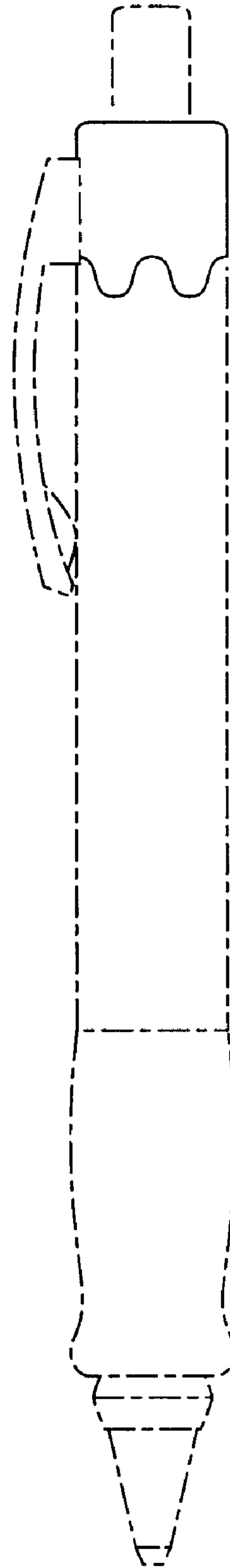

FIG. 5

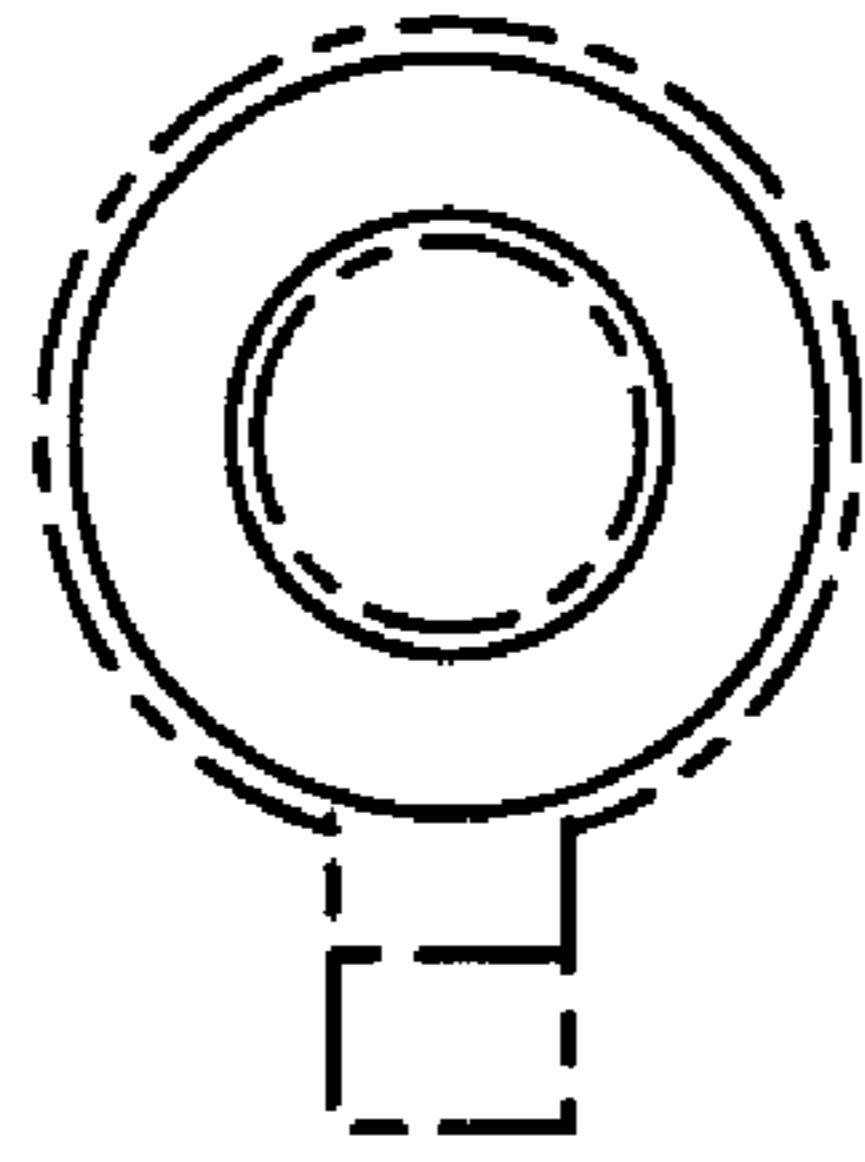

FIG. 6

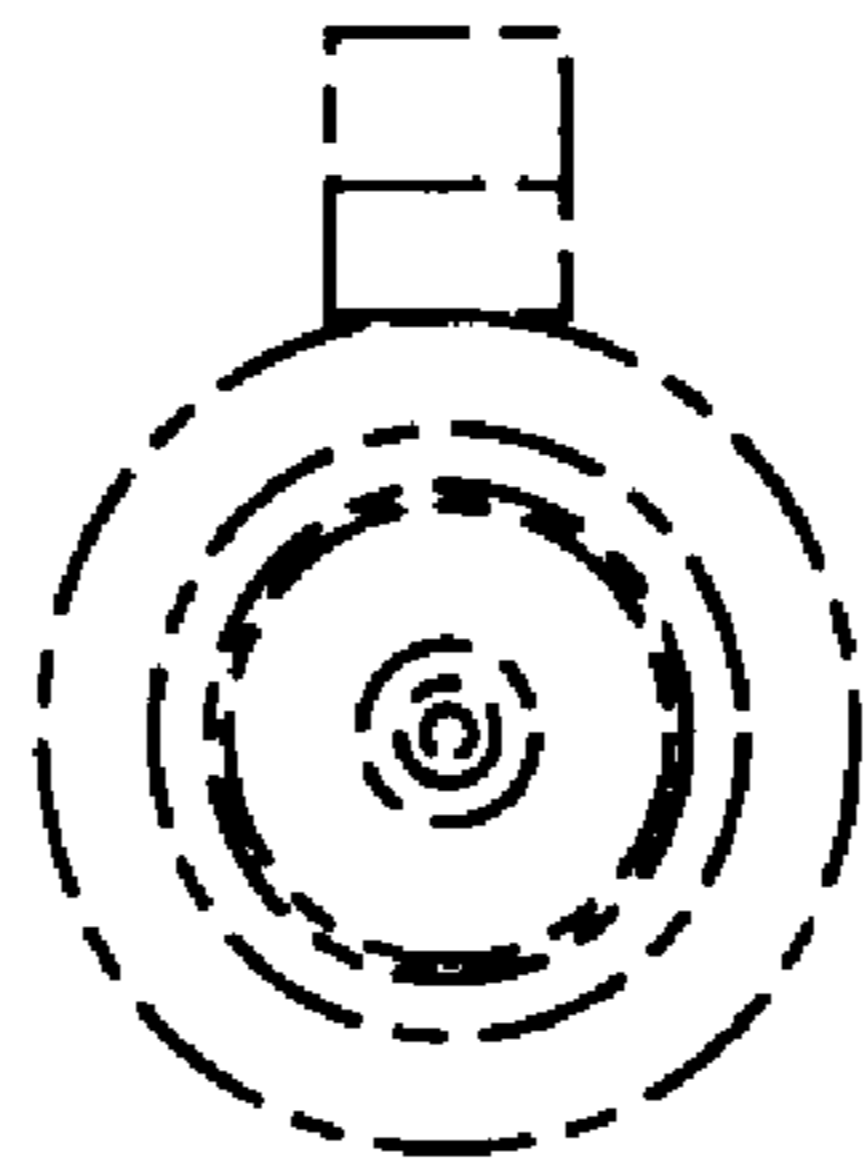

FIG. 7