



US00D577039S

(12) **United States Design Patent**
Shin et al.

(10) **Patent No.:** **US D577,039 S**

(45) **Date of Patent:** **** Sep. 16, 2008**

(54) **MP3 PLAYER**

(75) Inventors: **Cheol Woong Shin**, Seongnam-si (KR);
Jung In Koo, Seoul (KR)

(73) Assignee: **LG Electronics Inc.**, Seoul (KR)

(**) Term: **14 Years**

(21) Appl. No.: **29/290,599**

(22) Filed: **Dec. 19, 2007**

(30) **Foreign Application Priority Data**

Jun. 20, 2007 (KR) 30-2007-0026616

(51) **LOC (8) Cl.** **14-03**

(52) **U.S. Cl.** **D14/496**

(58) **Field of Classification Search** D14/496,
D14/401, 435, 474, 483, 217, 137, 138, 160,
D14/168; 345/156, 169, 173-179, 905; 715/727-729,
715/864; 710/1, 5, 8; 713/1, 600; 455/11,
455/1.7, 73, 344-347, 93, 95; 370/342-344;
369/1, 2, 6, 12; 463/43-47; 273/148 B
See application file for complete search history.

(56) **References Cited**

U.S. PATENT DOCUMENTS

D481,702 S * 11/2003 Takagi D14/156
D492,665 S * 7/2004 Lee D14/218

D510,081 S * 9/2005 Yang D14/156
D512,403 S * 12/2005 Yang D14/156
7,243,790 B2 * 7/2007 Civitello et al. 206/308.1
D550,704 S * 9/2007 Ichinose D14/496
D560,687 S * 1/2008 Kim et al. D14/496
D563,430 S * 3/2008 Deguchi et al. D14/496

* cited by examiner

Primary Examiner—Prabhakar Deshmukh

(74) *Attorney, Agent, or Firm*—Morgan, Lewis & Bockius
LLP

(57) **CLAIM**

The ornamental design for a MP3 player, as shown and described.

DESCRIPTION

FIG. 1 is a front, left perspective view of an MP3 player showing our new design;

FIG. 2 is a front view thereof;

FIG. 3 is a rear view thereof;

FIG. 4 is a left side view thereof;

FIG. 5 is a right side view thereof;

FIG. 6 is a top plan view thereof;

FIG. 7 is a bottom plan view thereof; and,

FIG. 8 is a bottom, perspective view thereof.

1 Claim, 4 Drawing Sheets

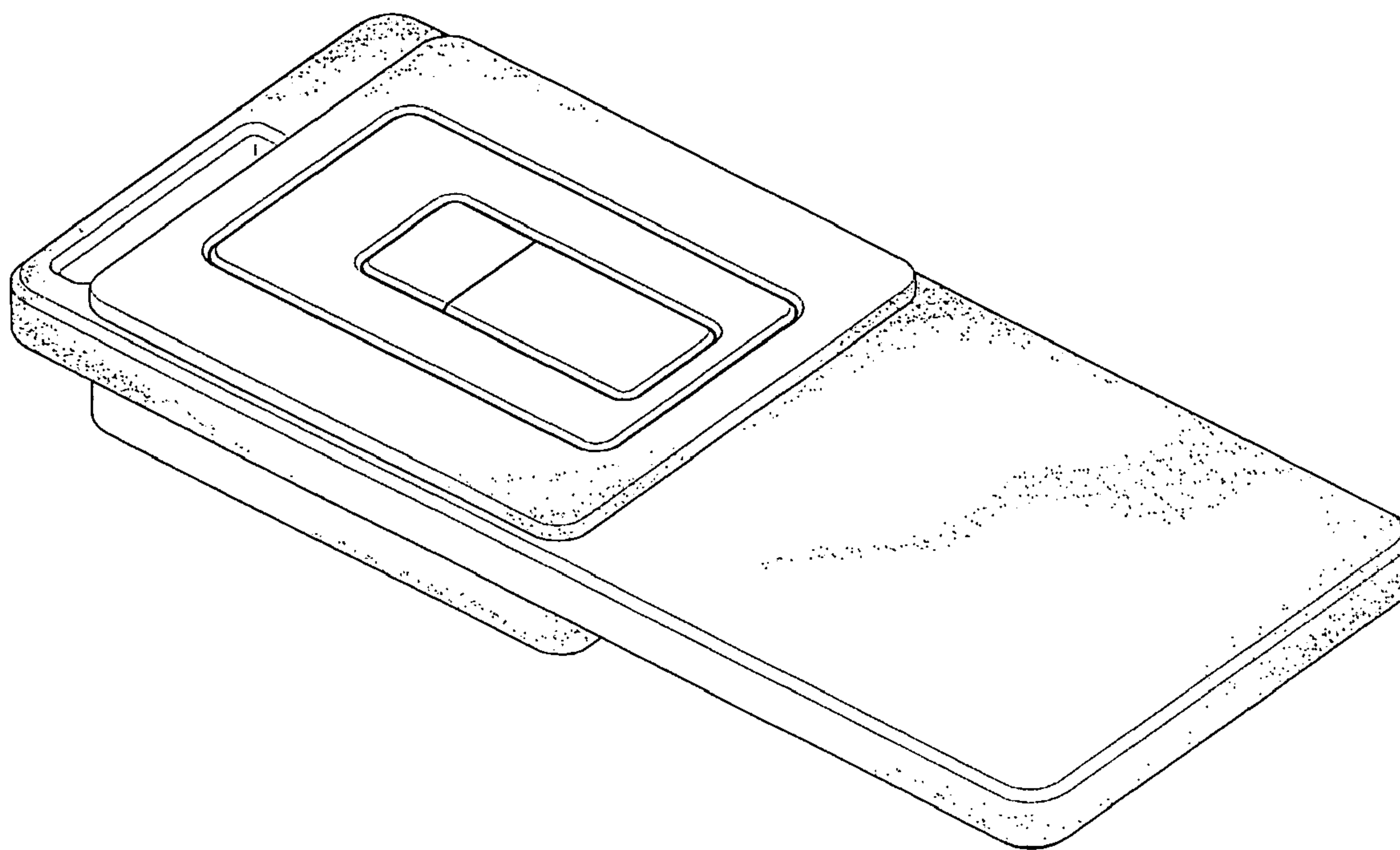

Fig. 1

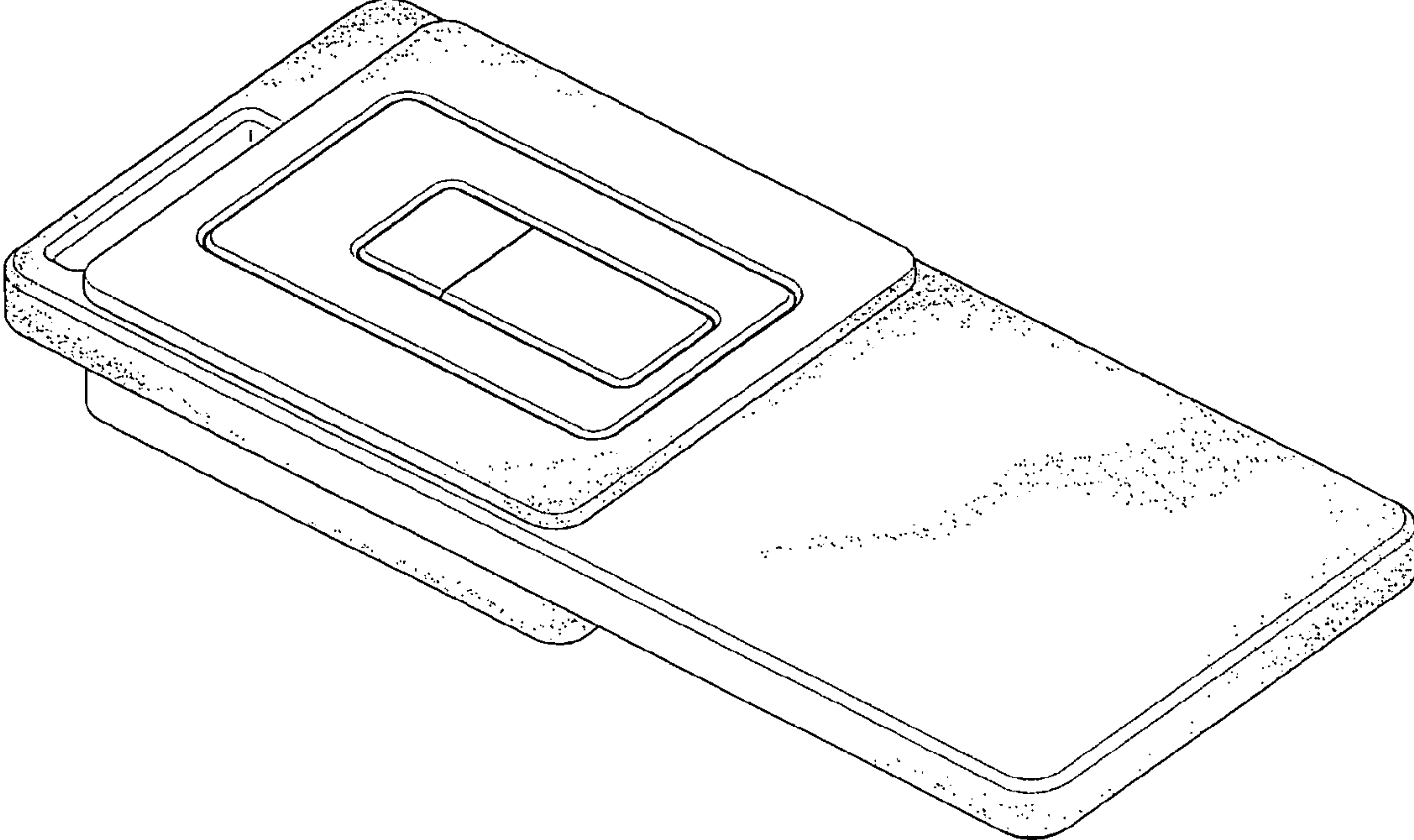

Fig. 2

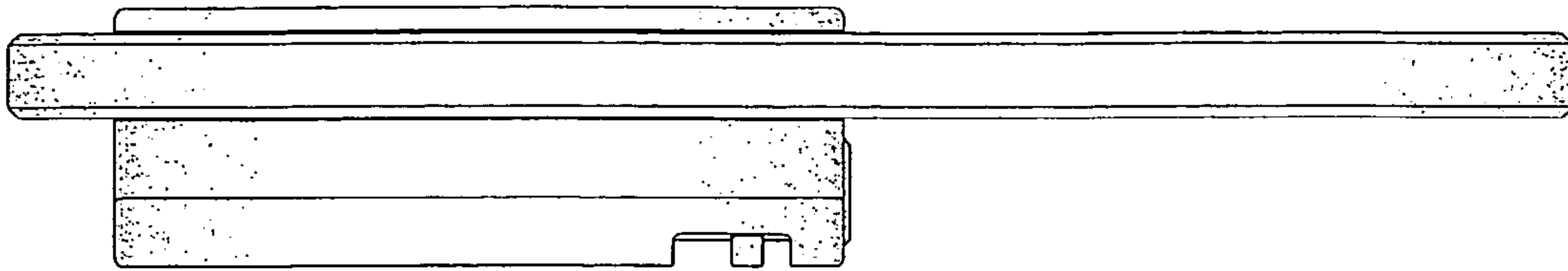

Fig. 3

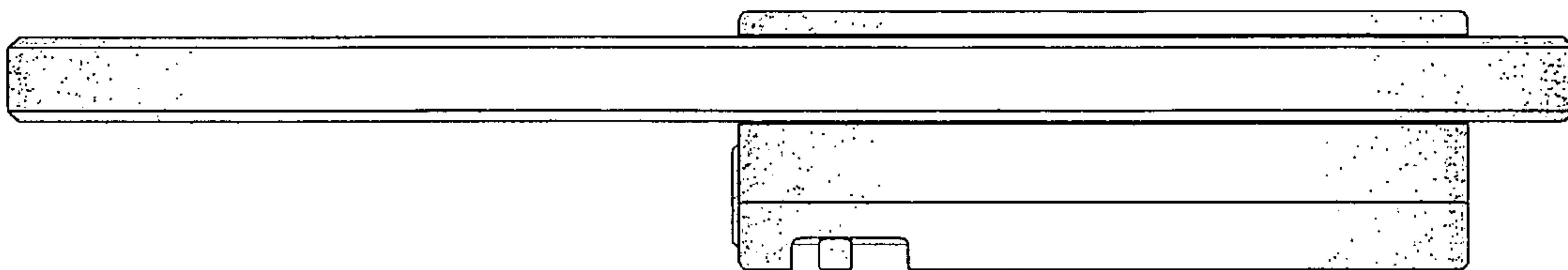

Fig. 4

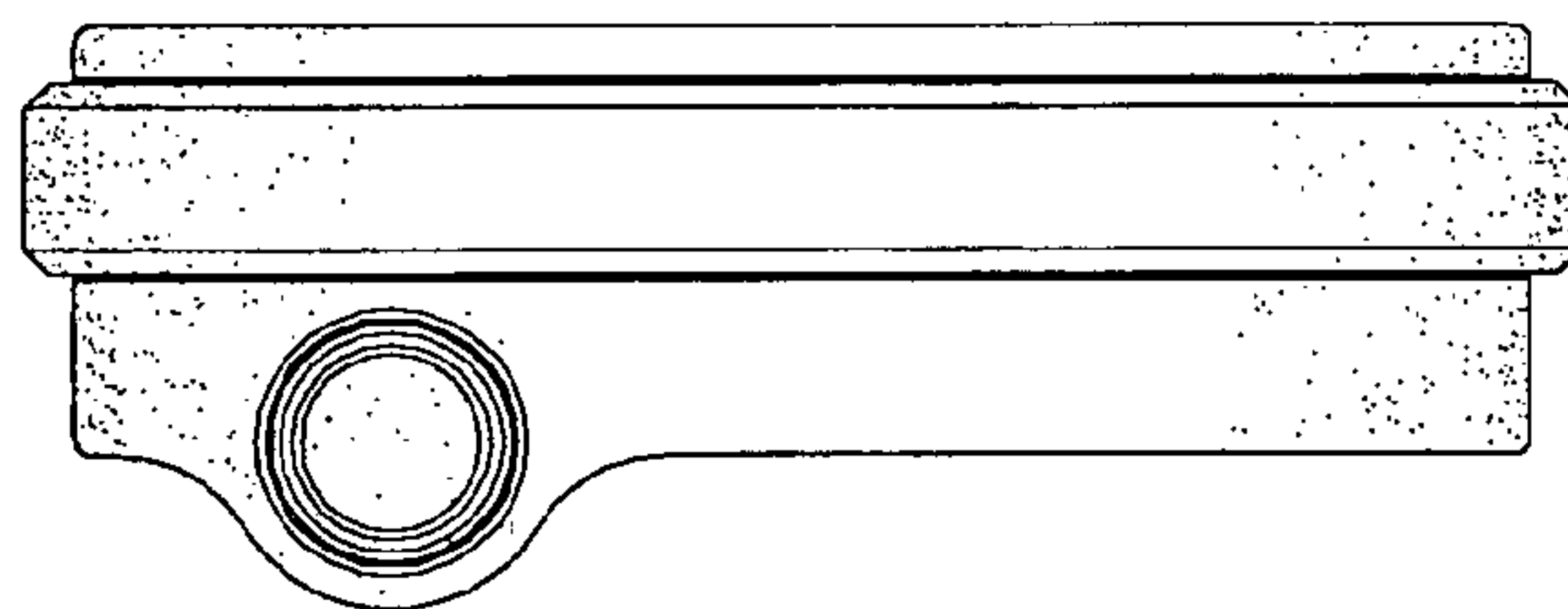

Fig. 5

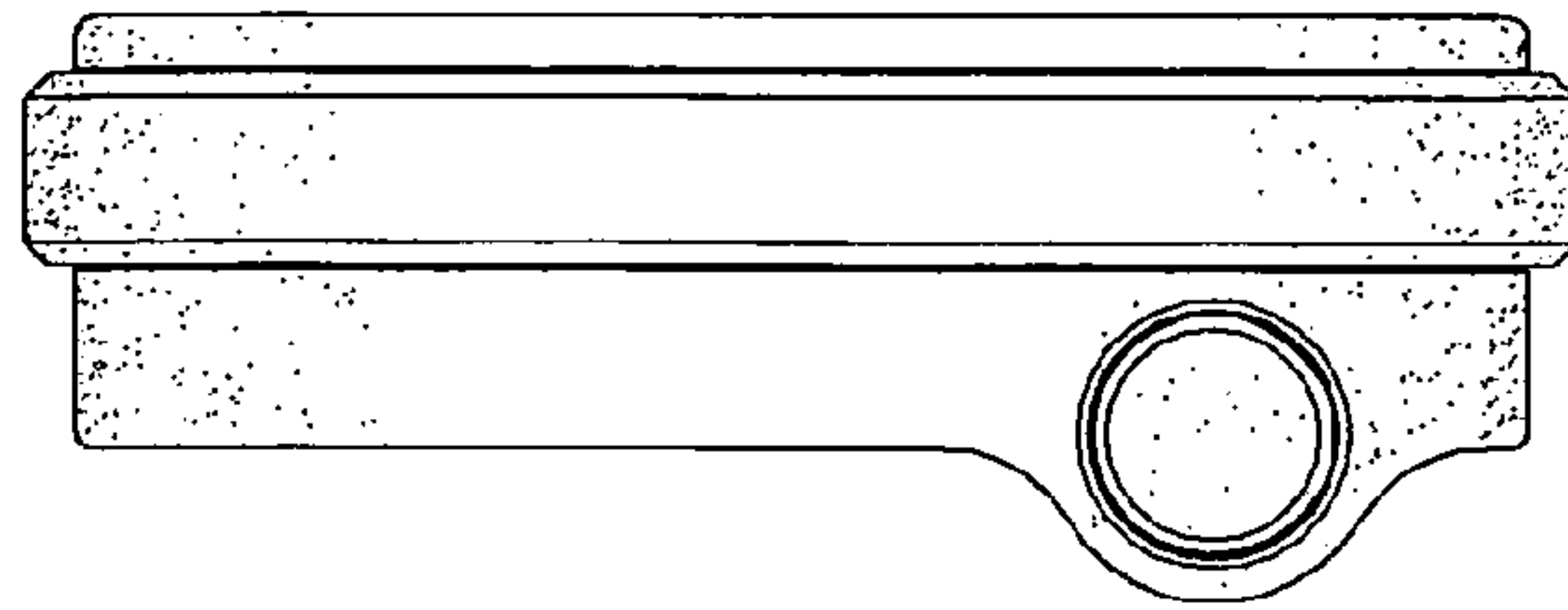

Fig. 6

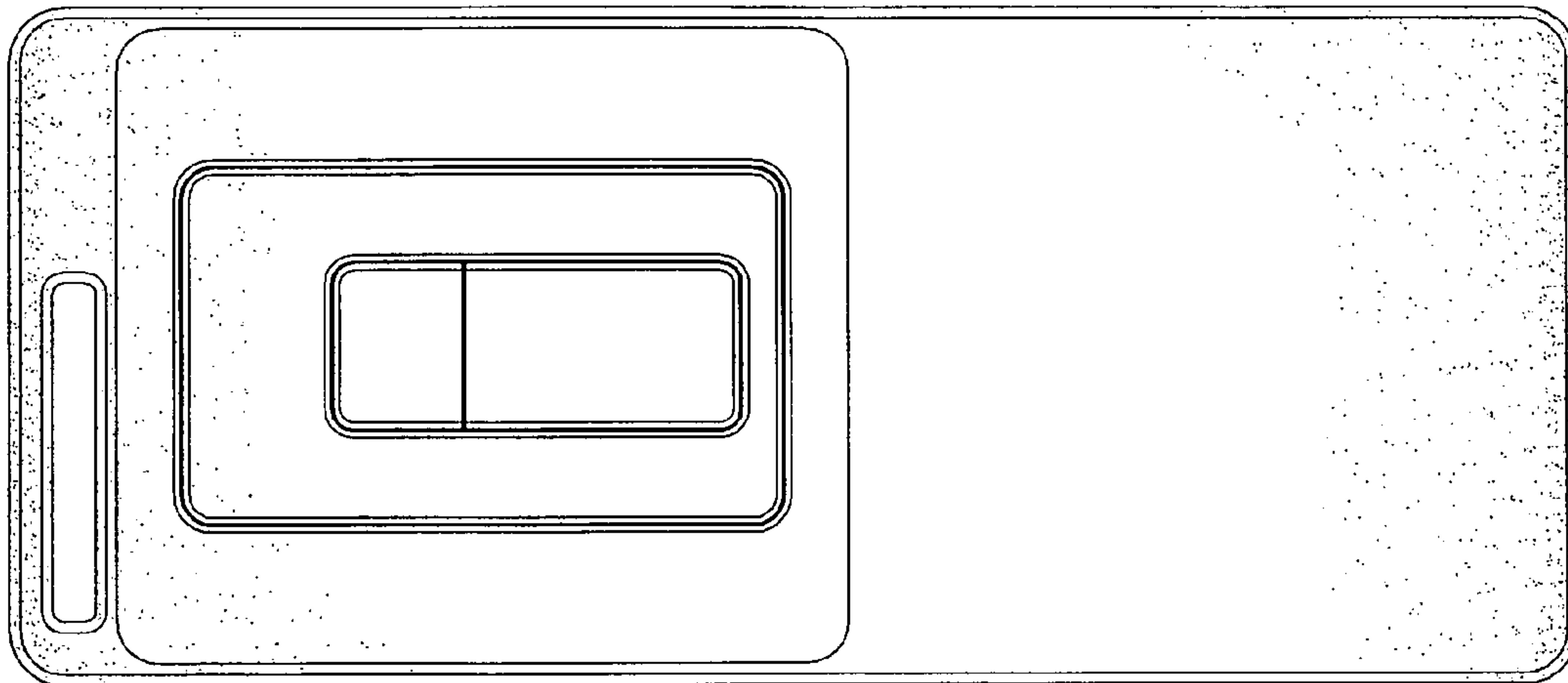

Fig. 7

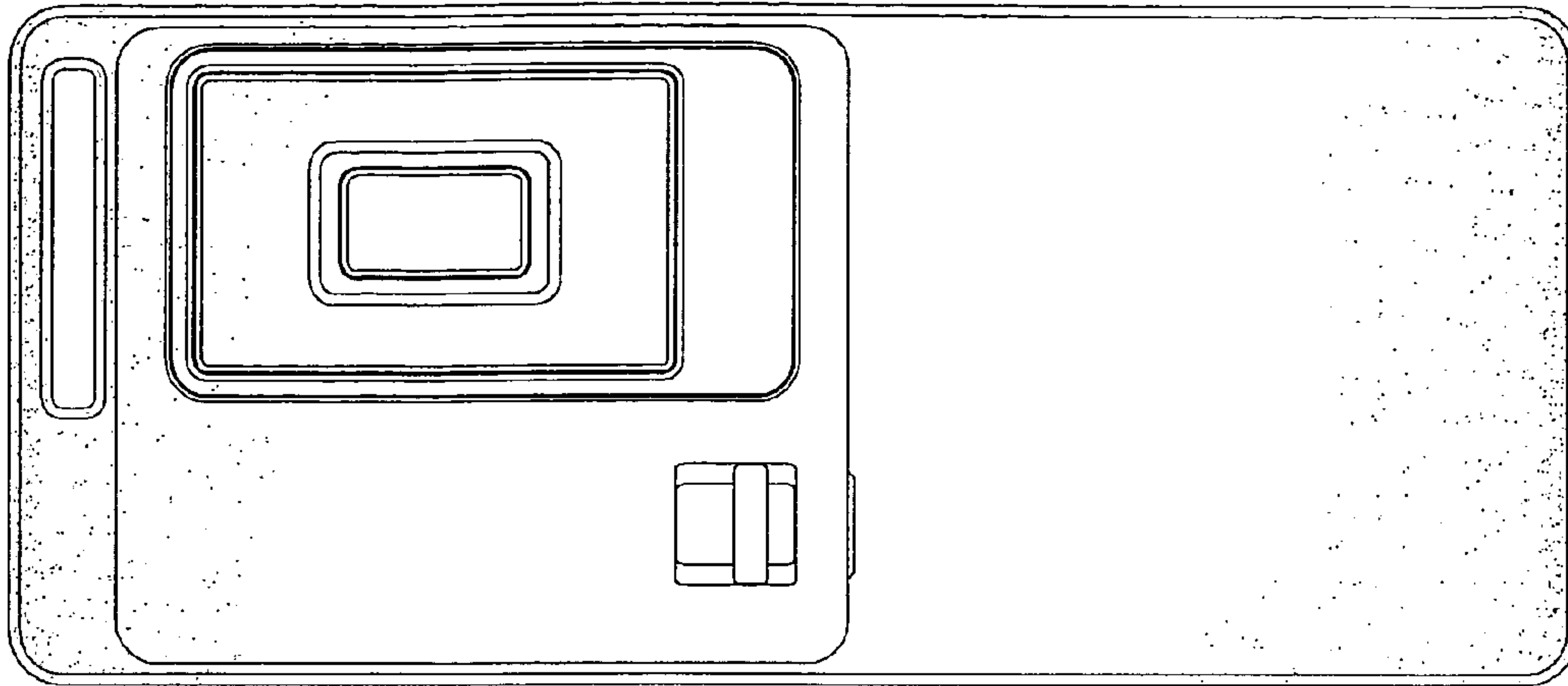

Fig. 8

