



US00D577017S

(12) **United States Design Patent**  
**Griffin et al.**

(10) **Patent No.:** **US D577,017 S**  
(45) **Date of Patent:** **\*\* Sep. 16, 2008**

(54) **HANDHELD DEVICE**

(75) Inventors: **Jason T. Griffin**, Kitchener (CA);  
**Cortez Corley**, Waterloo (CA); **Roman P. Rak**, Waterloo (CA); **Archer Wun**, North York (CA)

(73) Assignee: **Research In Motion Limited**, Waterloo, Ontario (CA)

(\*\*) Term: **14 Years**

(21) Appl. No.: **29/248,238**

(22) Filed: **Aug. 4, 2006**

(51) **LOC (8) Cl.** ..... **14-02**

(52) **U.S. Cl.** ..... **D14/346**

(58) **Field of Classification Search** ..... D14/341, D14/342, 343, 344, 345, 346, 347, 452, 374, D14/426, 496, 137, 138, 247, 248, 455, 456, D14/420, 427, 432, 439, 440, 441, 448, 125, D14/129, 130, 250, 389, 147, 218, 156, 126; D21/517, 329, 331, 686; D18/7, 6; D10/65, D10/104; 345/169, 173; 379/433.04, 433.06, 379/433.07, 433.11, 433.12, 433.13; 348/14.02; 455/556.1, 556.2, 566, 575.1, 575.4, 90.3, 455/575.3; 349/12; D13/168; D6/596, 601, D6/605; 361/814; 341/22

See application file for complete search history.

(56) **References Cited**

**U.S. PATENT DOCUMENTS**

D524,786 S \* 7/2006 Paradise et al. .... D14/138  
D525,222 S \* 7/2006 Corley et al. .... D14/138

D525,223 S \* 7/2006 Griffin ..... D14/138  
D534,514 S \* 1/2007 Hering ..... D14/138  
D543,190 S \* 5/2007 Huang et al. .... D14/138  
D545,803 S \* 7/2007 Chen ..... D14/138  
D546,349 S \* 7/2007 Lee ..... D14/496  
D556,725 S \* 12/2007 Kim et al. .... D14/138  
2006/0100004 A1 \* 5/2006 Kim et al. .... 455/575.3  
2006/0158428 A1 \* 7/2006 Lazaridis et al. .... 345/157  
2007/0120960 A1 \* 5/2007 Chang ..... 348/14.02  
2007/0232361 A1 \* 10/2007 Park et al. .... 455/566  
2007/0275765 A1 \* 11/2007 Chao et al. .... 455/566

\* cited by examiner

*Primary Examiner*—Cathron Brooks

*Assistant Examiner*—Angela J Lee

(74) *Attorney, Agent, or Firm*—Brij K. Agarwal; Eckert Seamans Cherin & Mellott, LLC

(57) **CLAIM**

The ornamental design for a handheld device, as shown and described.

**DESCRIPTION**

FIG. 1 is a front elevational view of a handheld device depicting our new design;

FIG. 2 is a left side elevational view thereof;

FIG. 3 is a right side elevational view thereof;

FIG. 4 is a top plan view thereof;

FIG. 5 is a bottom plan view thereof; and,

FIG. 6 is a perspective view thereof.

The broken line showing of the rectangles defines the bounds of the claimed design and forms no part thereof.

**1 Claim, 4 Drawing Sheets**

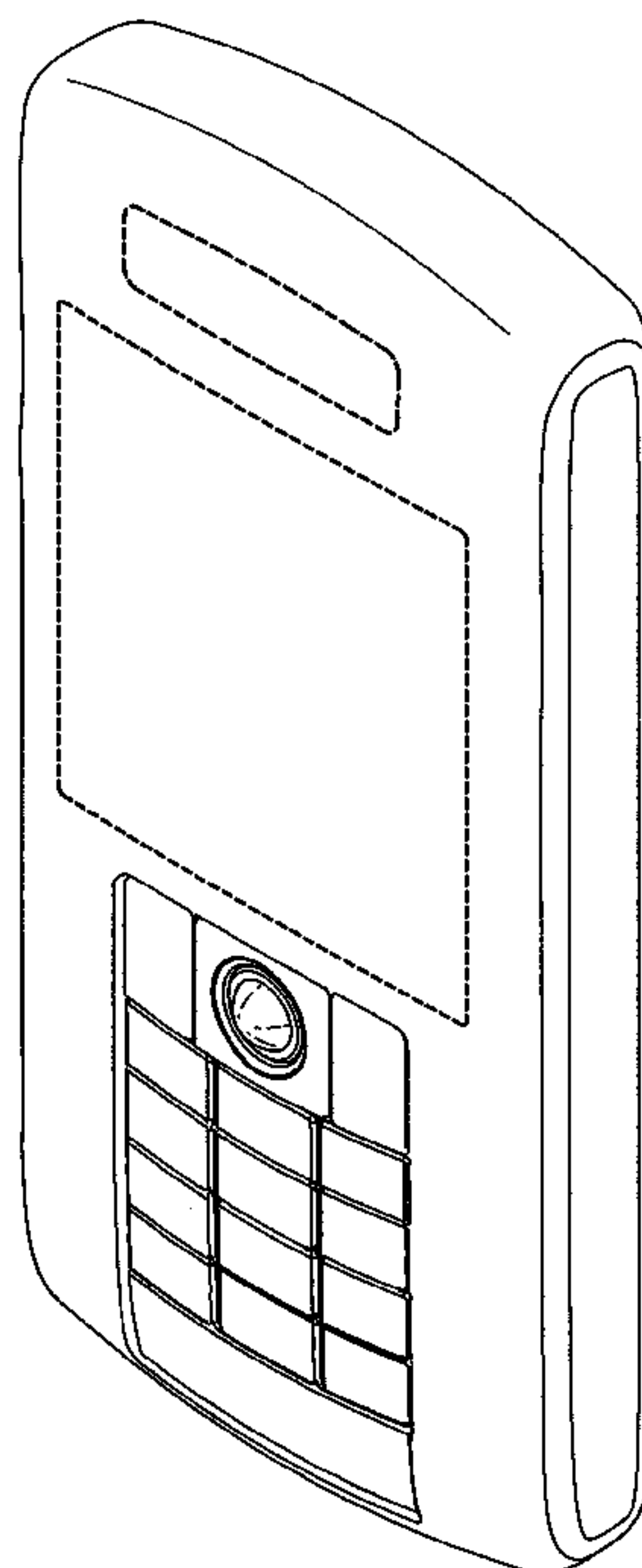

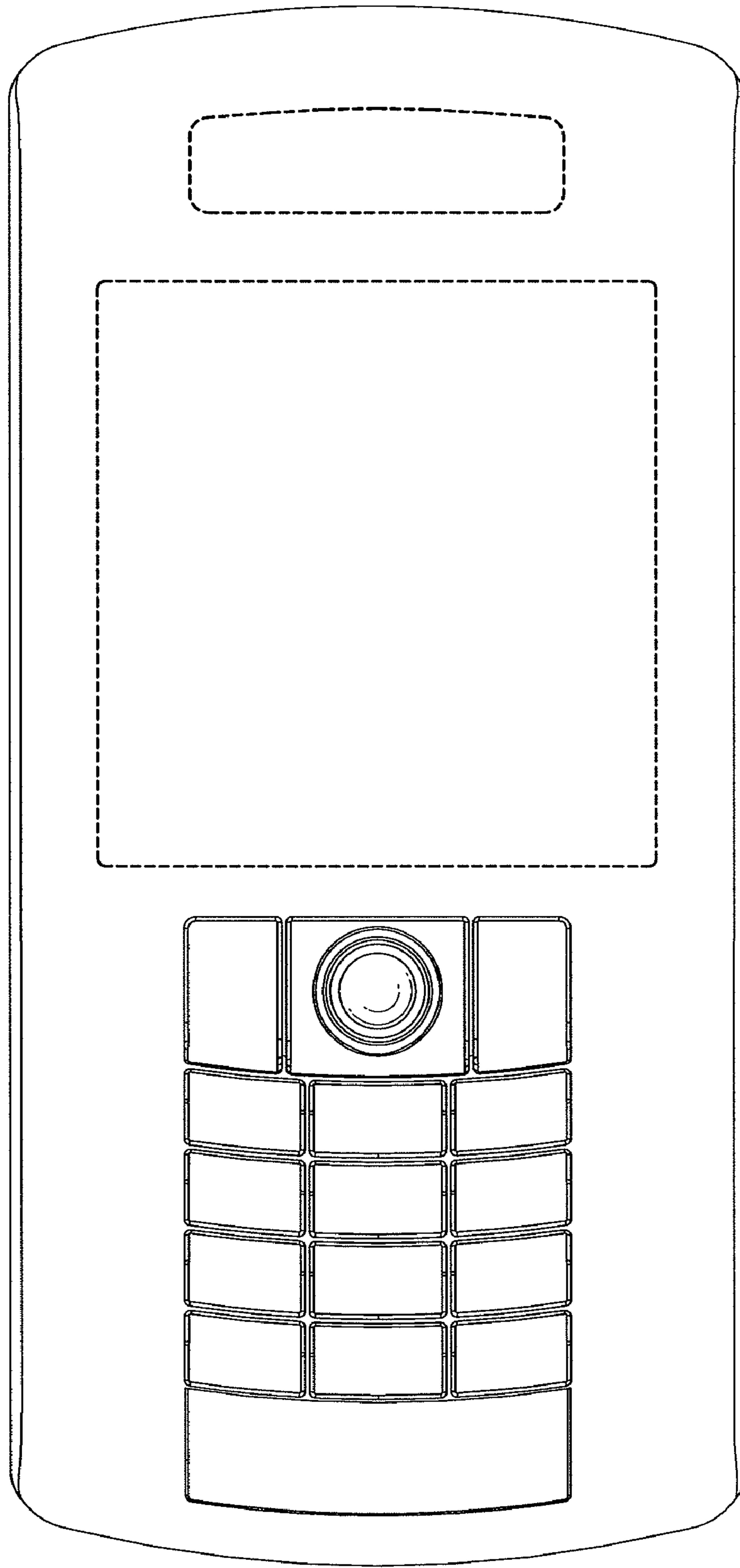
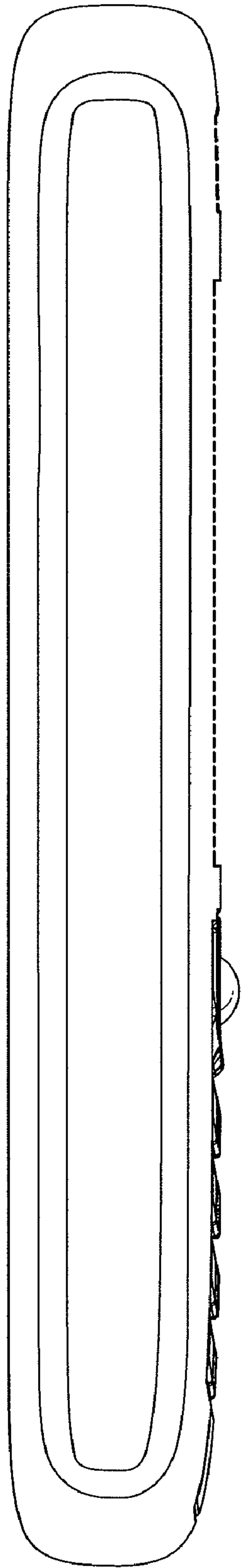
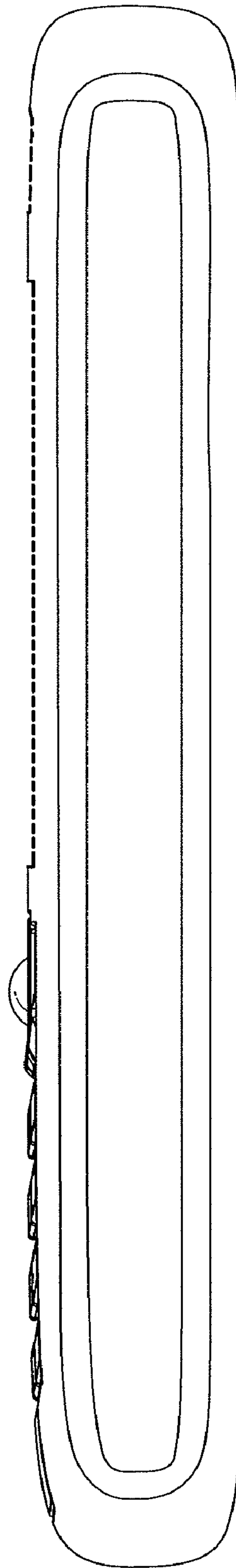

FIG.1



*FIG. 2*



*FIG. 3*

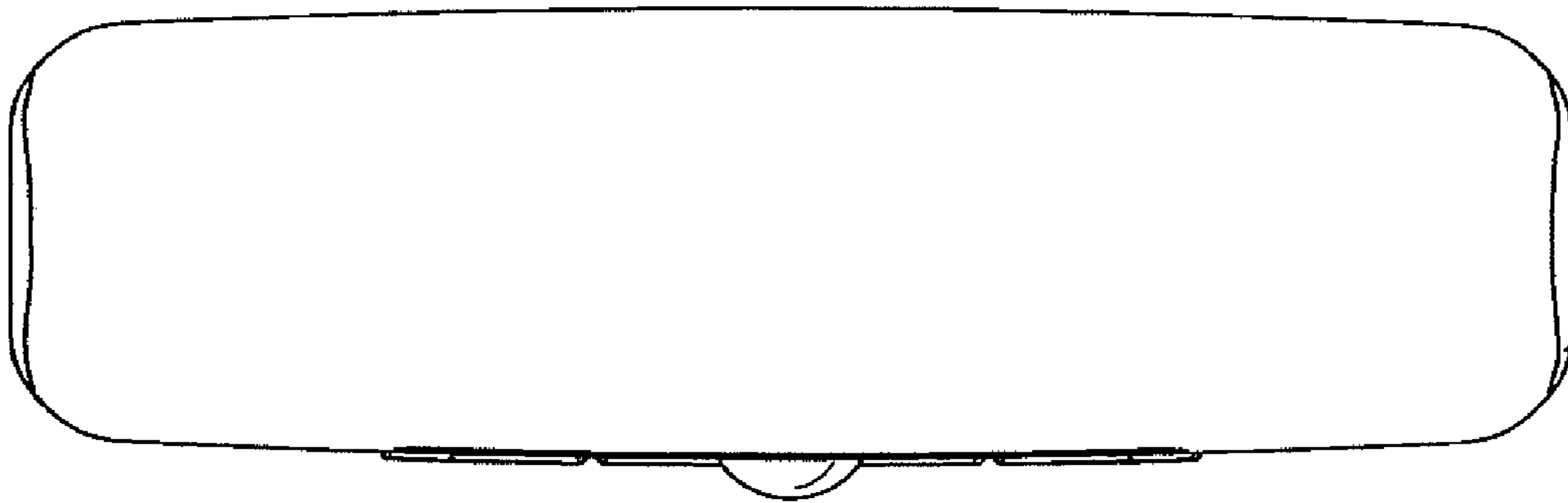

*FIG. 4*

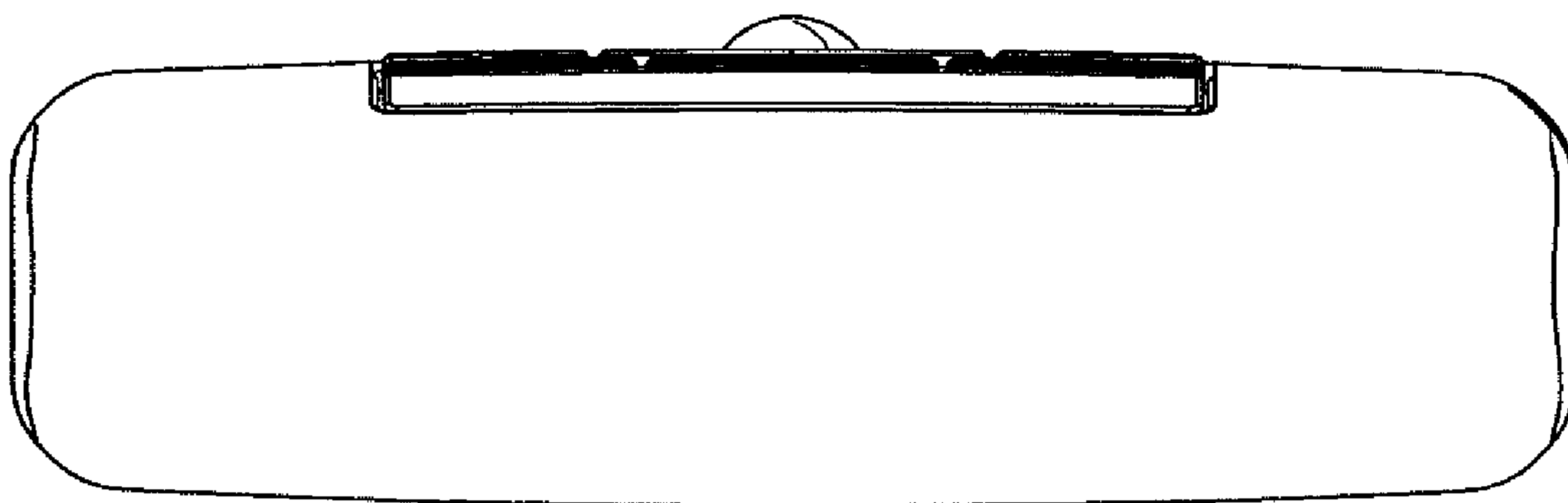

*FIG. 5*

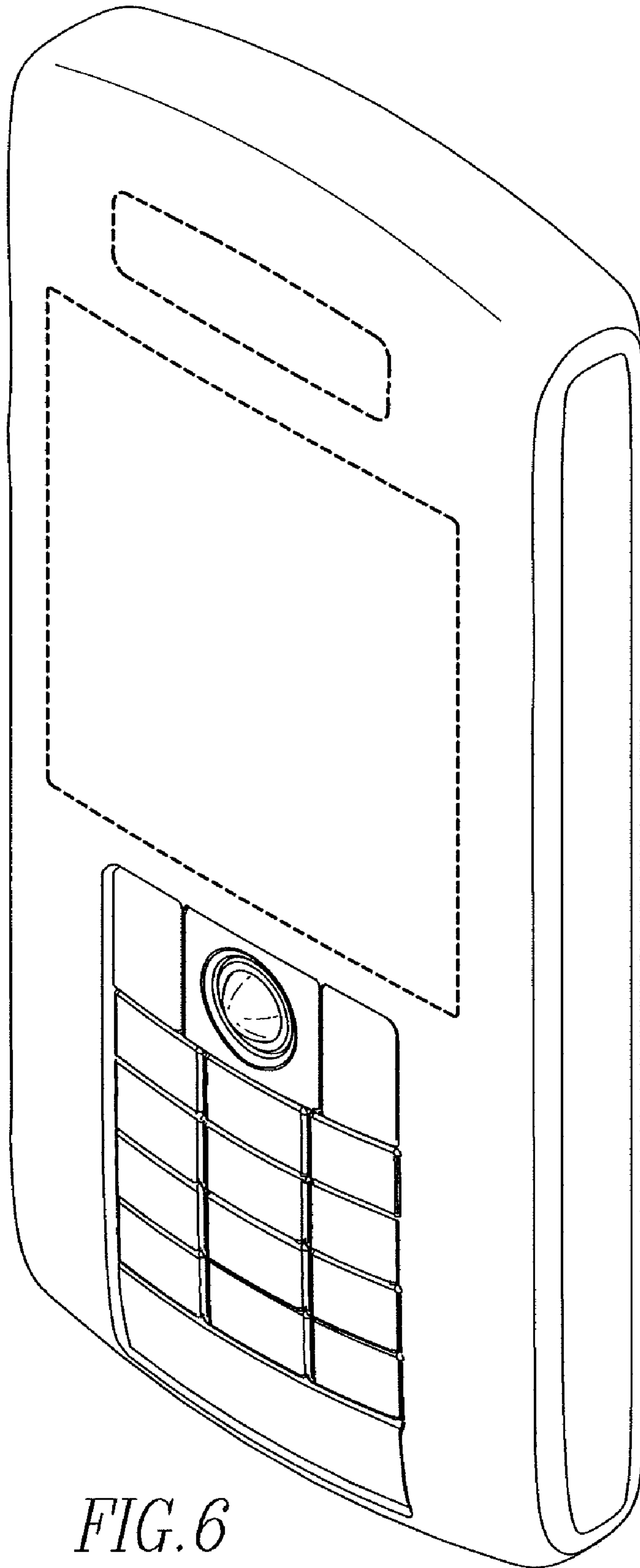

*FIG. 6*