



US00D577015S

(12) **United States Design Patent**
Griffin et al.

(10) **Patent No.:** **US D577,015 S**
(45) **Date of Patent:** **** Sep. 16, 2008**

(54) **HANDHELD DEVICE**

(75) Inventors: **Jason T. Griffin**, Kitchener (CA);
Cortez Corley, Waterloo (CA); **Roman P. Rak**, Waterloo (CA); **Archer Wun**, North York (CA)

(73) Assignee: **Research In Motion Limited**, Waterloo, Ontario (CA)

(**) Term: **14 Years**

(21) Appl. No.: **29/248,237**

(22) Filed: **Aug. 4, 2006**

(51) **LOC (8) Cl.** **14-02**

(52) **U.S. Cl.** **D14/341; D14/138**

(58) **Field of Classification Search** D14/346, D14/341, 342, 343, 344, 345, 347, 439, 137, D14/138, 374, 248, 496, 125, 129; 345/169, 345/173; 379/433.04, 433.06, 433.07, 433.11, 379/433.12, 433.13; 348/14.02; 455/556.1, 455/556.2, 566, 575.1, 575.3, 575.4, 90.3; 341/22; D13/168; D18/6, 7; D21/329, 331
See application file for complete search history.

(56) **References Cited**

U.S. PATENT DOCUMENTS

D468,714 S * 1/2003 Maruska et al. D14/138
D505,934 S * 6/2005 Gonser D14/138
D524,786 S * 7/2006 Paradise et al. D14/138
7,130,669 B2 * 10/2006 Moon 455/575.3
D543,190 S * 5/2007 Huang et al. D14/138
D545,803 S * 7/2007 Chen D14/138
D550,186 S * 9/2007 Rak D14/138

D550,665 S * 9/2007 Griffin et al. D14/346
7,274,354 B2 * 9/2007 Yamamoto et al. 345/157
D556,725 S * 12/2007 Kim et al. D14/138
2004/0222971 A1 * 11/2004 Mo 345/169
2007/0188462 A1 * 8/2007 Lee et al. 345/167
2007/0232361 A1 * 10/2007 Park et al. 455/566

FOREIGN PATENT DOCUMENTS

EM 000575345-0004 * 8/2006

* cited by examiner

Primary Examiner—Jennifer Rivard

Assistant Examiner—Angela J Lee

(74) *Attorney, Agent, or Firm*—Brij K. Agarwal; Eckert Seamans Cherin & Mellott, LLC

(57) **CLAIM**

The ornamental design for a handheld device, as shown and described.

DESCRIPTION

FIG. 1 is a front elevational view of a handheld device depicting our new design;

FIG. 2 is a left side elevational view thereof;

FIG. 3 is a right side elevational view thereof;

FIG. 4 is a top plan view thereof;

FIG. 5 is a bottom plan view thereof;

FIG. 6 is a rear elevational view thereof;

FIG. 7 is a perspective view thereof; and,

FIG. 8 is another perspective view thereof.

The broken line showing of portions of the handheld device forms no part of the claimed design.

1 Claim, 6 Drawing Sheets

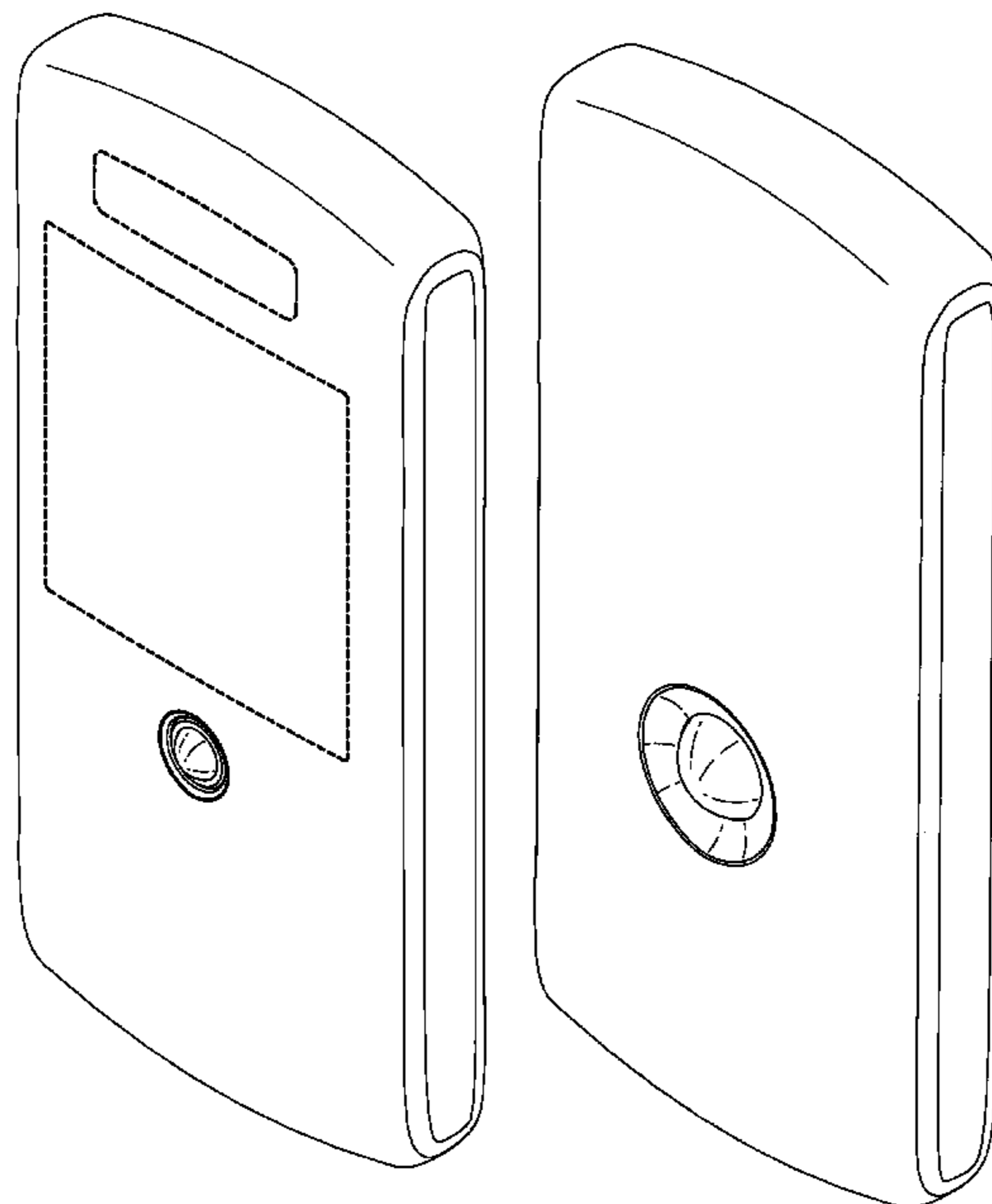

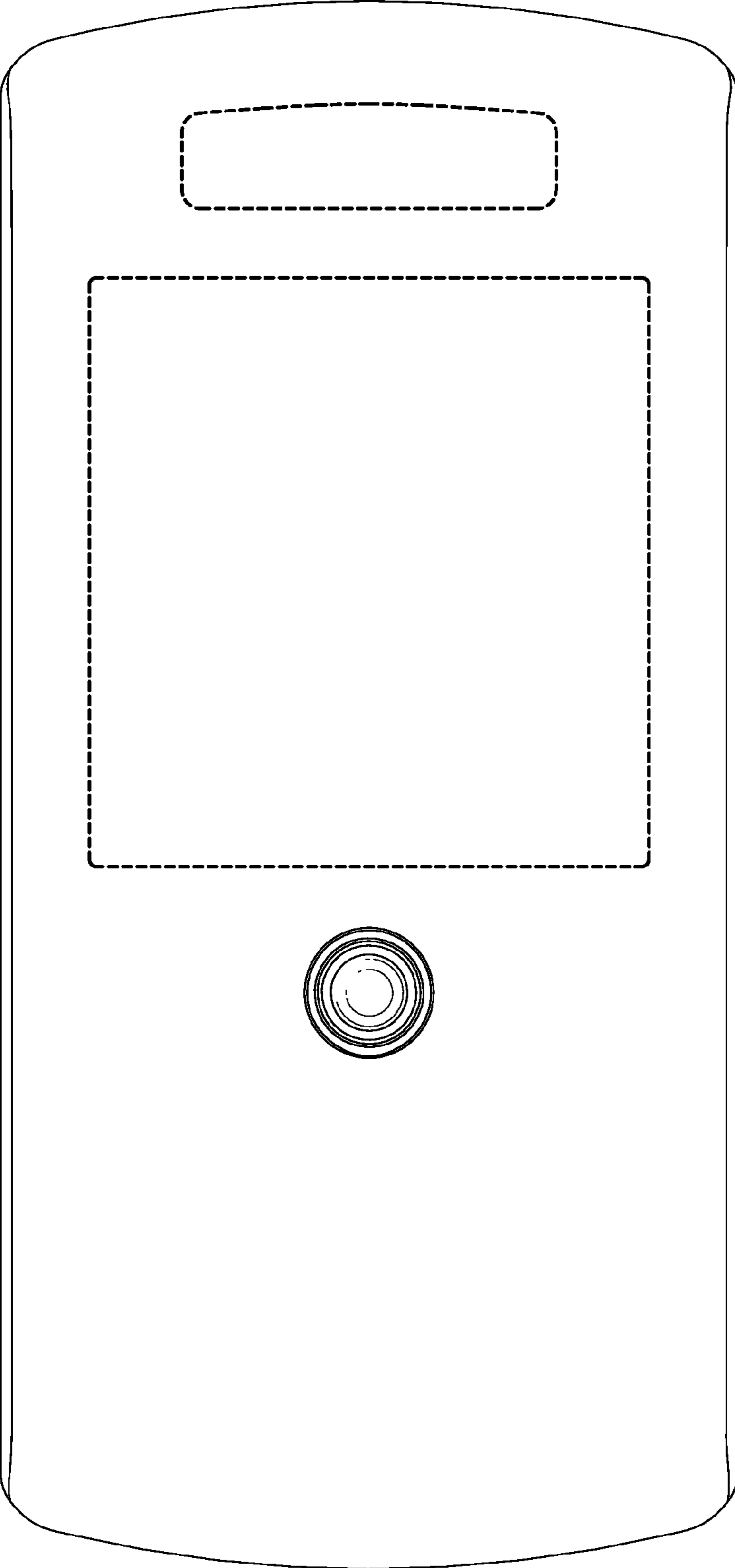

FIG.1

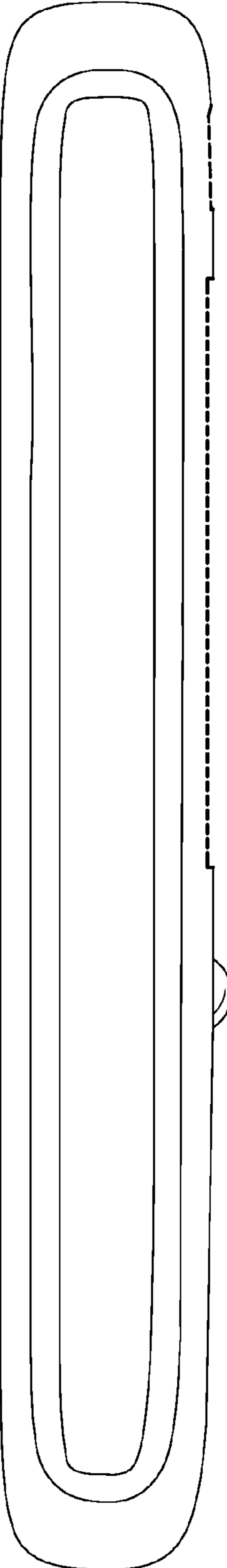

FIG. 2

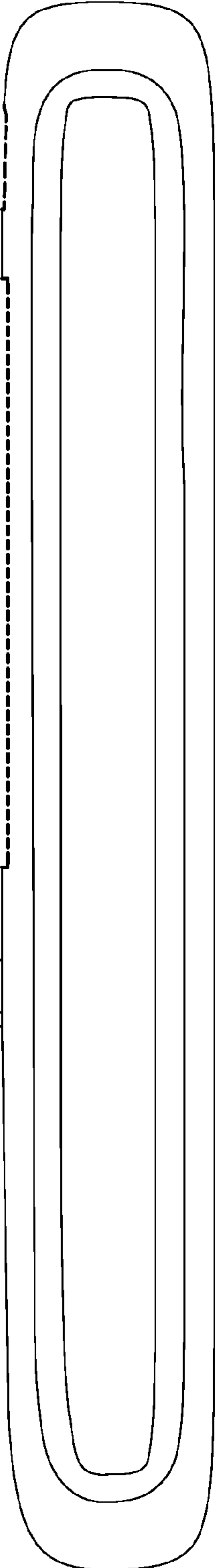

FIG. 3

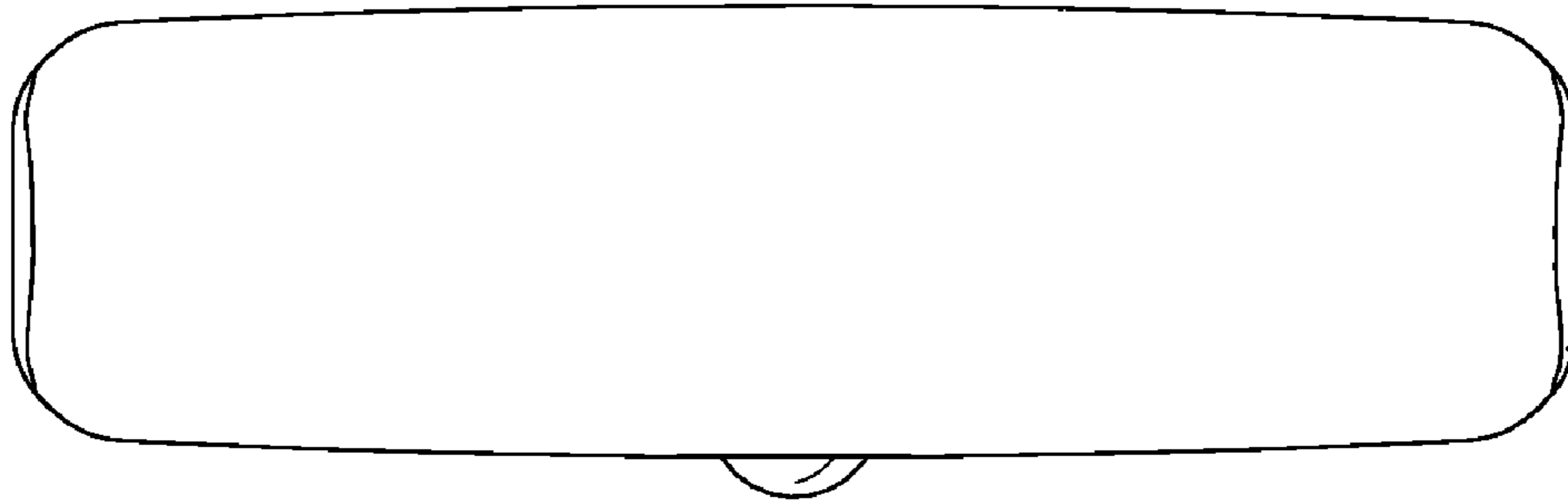

FIG. 4

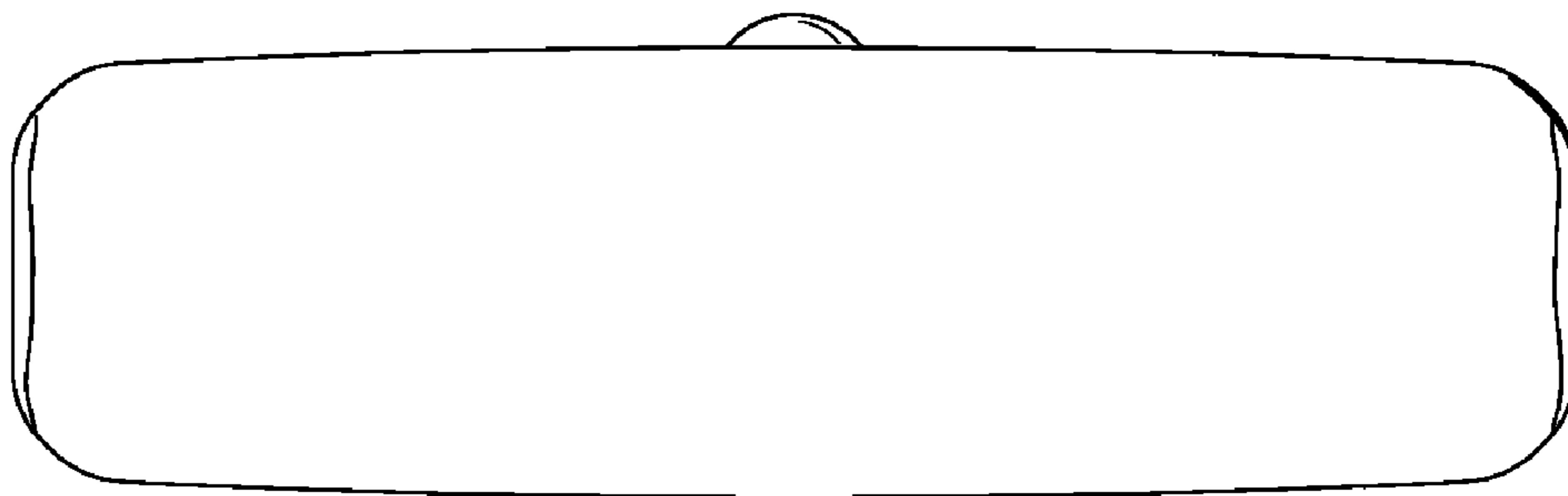

FIG. 5

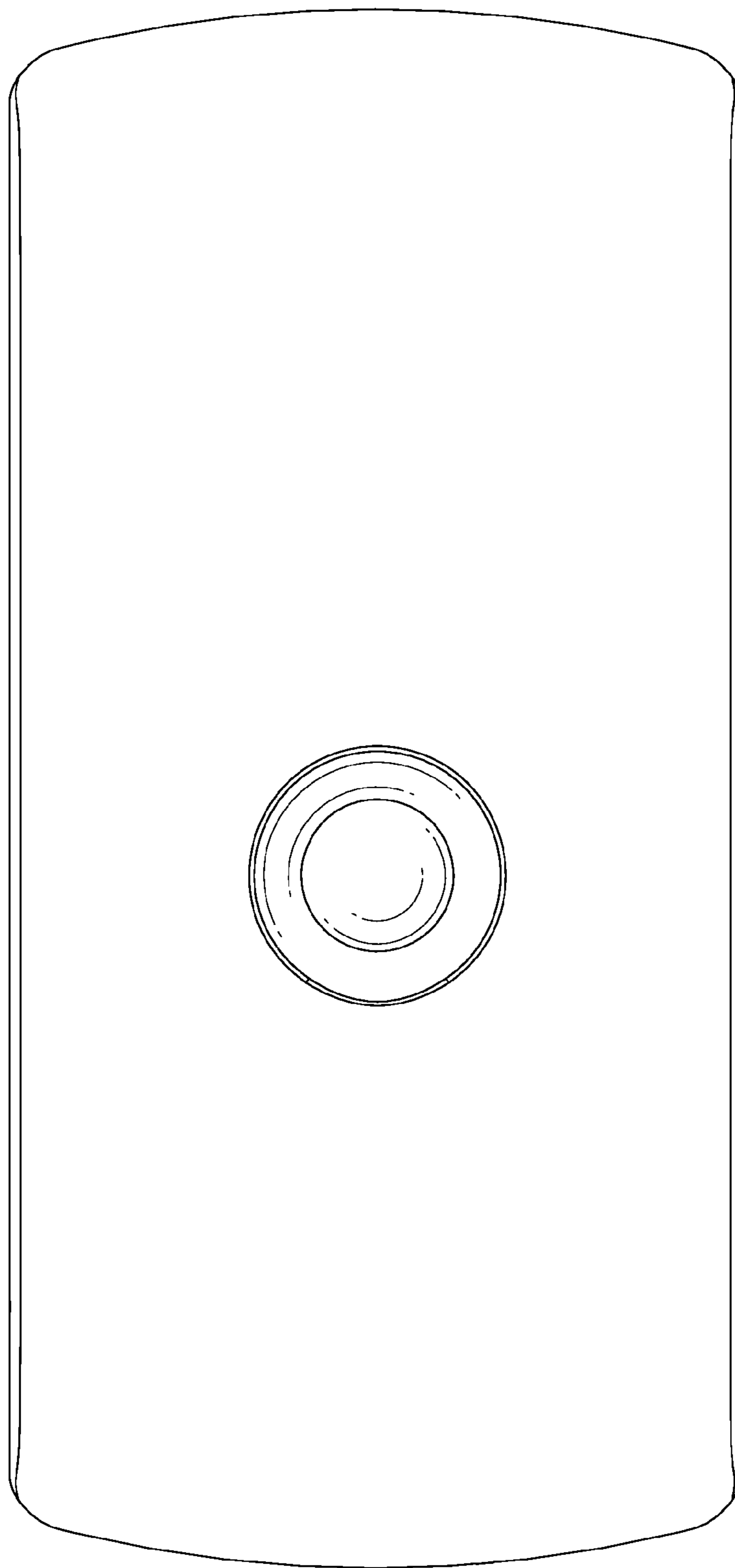

FIG. 6

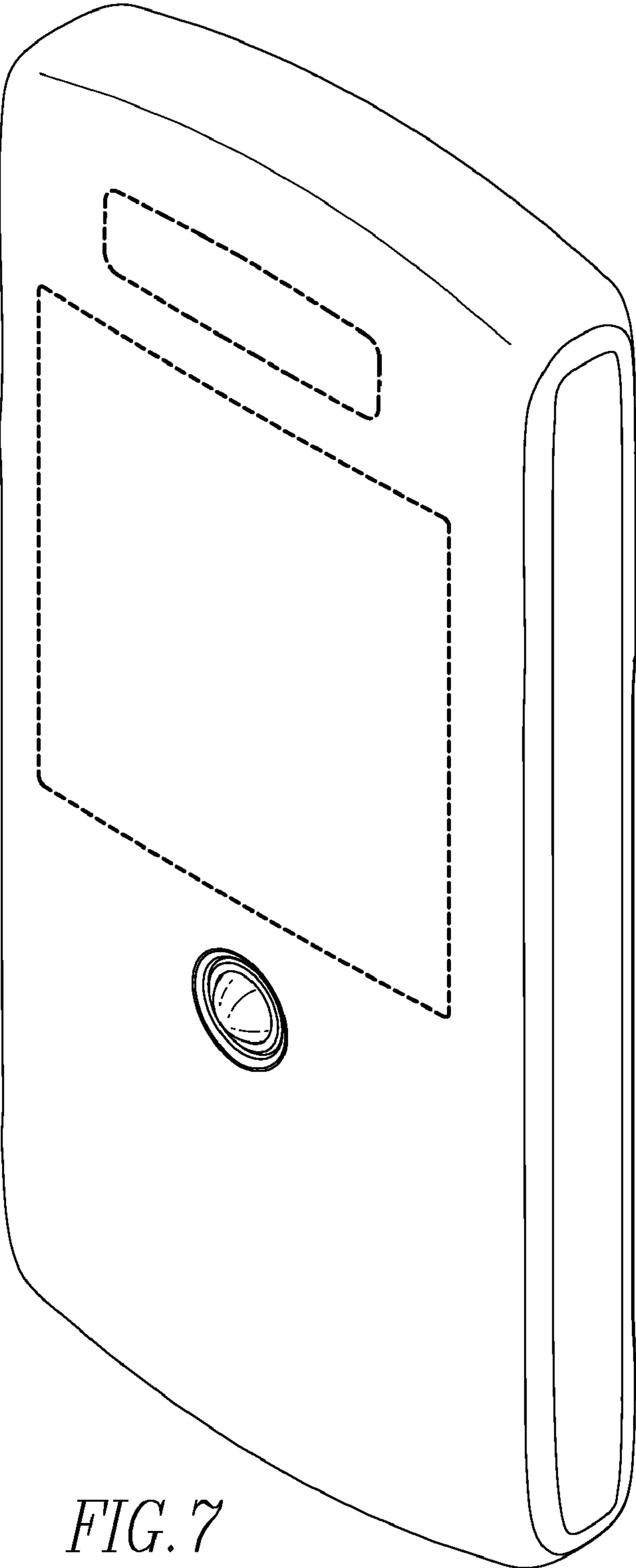

FIG. 7

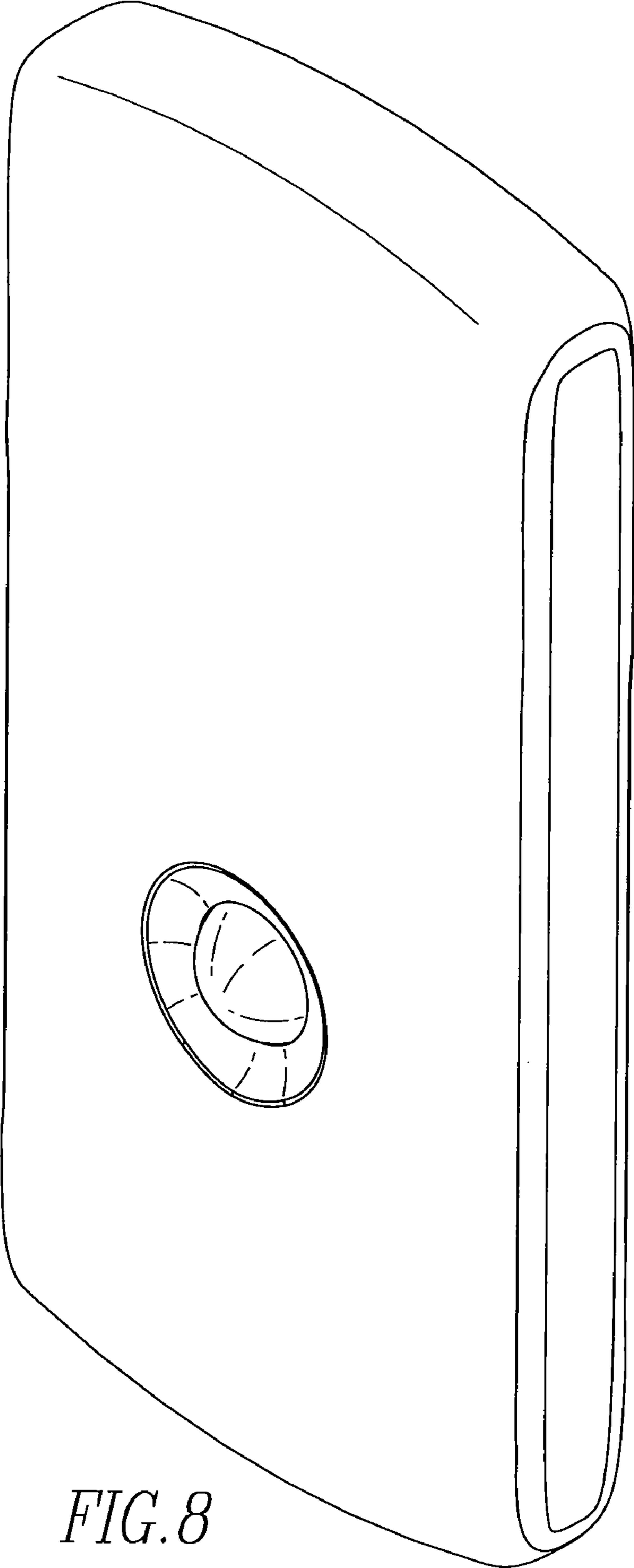

FIG. 8