



US00D577014S

(12) **United States Design Patent**  
**Griffin et al.**

(10) **Patent No.:** **US D577,014 S**  
(45) **Date of Patent:** **\*\* Sep. 16, 2008**

(54) **HANDHELD DEVICE**

(75) Inventors: **Jason T. Griffin**, Kitchener (CA);  
**Cortez Corley**, Waterloo (CA); **Roman P. Rak**, Waterloo (CA); **Archer Wun**, North York (CA)

(73) Assignee: **Research In Motion Limited**, Waterloo, Ontario (CA)

(\*\*) Term: **14 Years**

(21) Appl. No.: **29/248,236**

(22) Filed: **Aug. 4, 2006**

(51) **LOC (8) Cl.** ..... **14-02**

(52) **U.S. Cl.** ..... **D14/341**; D14/138

(58) **Field of Classification Search** ..... D14/346, D14/341, 342, 343, 344, 345, 347, 439, 137, D14/138, 374, 248, 496, 125, 129; 345/169, 345/173; 379/433.04, 433.06, 433.07, 433.11, 379/433.12, 433.13; 348/14.02; 455/556.1, 455/556.2, 566, 575.1, 575.3, 575.4, 90.3; 341/22; D13/168; D18/6, 7; D21/329, 331  
See application file for complete search history.

(56) **References Cited**

U.S. PATENT DOCUMENTS

D468,714 S \* 1/2003 Maruska et al. .... D14/138  
D505,934 S \* 6/2005 Gonser ..... D14/138  
D524,786 S \* 7/2006 Paradise et al. .... D14/138  
7,130,669 B2 \* 10/2006 Moon ..... 455/575.3  
D543,190 S \* 5/2007 Huang et al. .... D14/138  
D545,803 S \* 7/2007 Chen ..... D14/138  
D550,186 S \* 9/2007 Rak ..... D14/138

D550,665 S \* 9/2007 Griffin et al. .... D14/346  
7,274,354 B2 \* 9/2007 Yamamoto et al. .... 345/157  
D556,725 S \* 12/2007 Kim et al. .... D14/138  
2004/0222971 A1 \* 11/2004 Mo ..... 345/169  
2007/0188462 A1 \* 8/2007 Lee et al. .... 345/167  
2007/0232361 A1 \* 10/2007 Park et al. .... 455/566

FOREIGN PATENT DOCUMENTS

EM 000575345-0003 \* 8/2006

\* cited by examiner

*Primary Examiner*—Jennifer Rivard

*Assistant Examiner*—Angela J Lee

(74) *Attorney, Agent, or Firm*—Brij K. Agarwal; Eckert Seamans Cherin & Mellot, LLC

(57) **CLAIM**

The ornamental design for a handheld device, as shown and described.

**DESCRIPTION**

FIG. 1 is a front elevational view of a handheld device depicting our new design;

FIG. 2 is a left side elevational view thereof;

FIG. 3 is a right side elevational view thereof;

FIG. 4 is a top plan view thereof;

FIG. 5 is a bottom plan view thereof;

FIG. 6 is a rear elevational view thereof;

FIG. 7 is a perspective view thereof; and,

FIG. 8 is another perspective view thereof.

The broken line showing of portions of the handheld device forms no part of the claimed design.

**1 Claim, 6 Drawing Sheets**

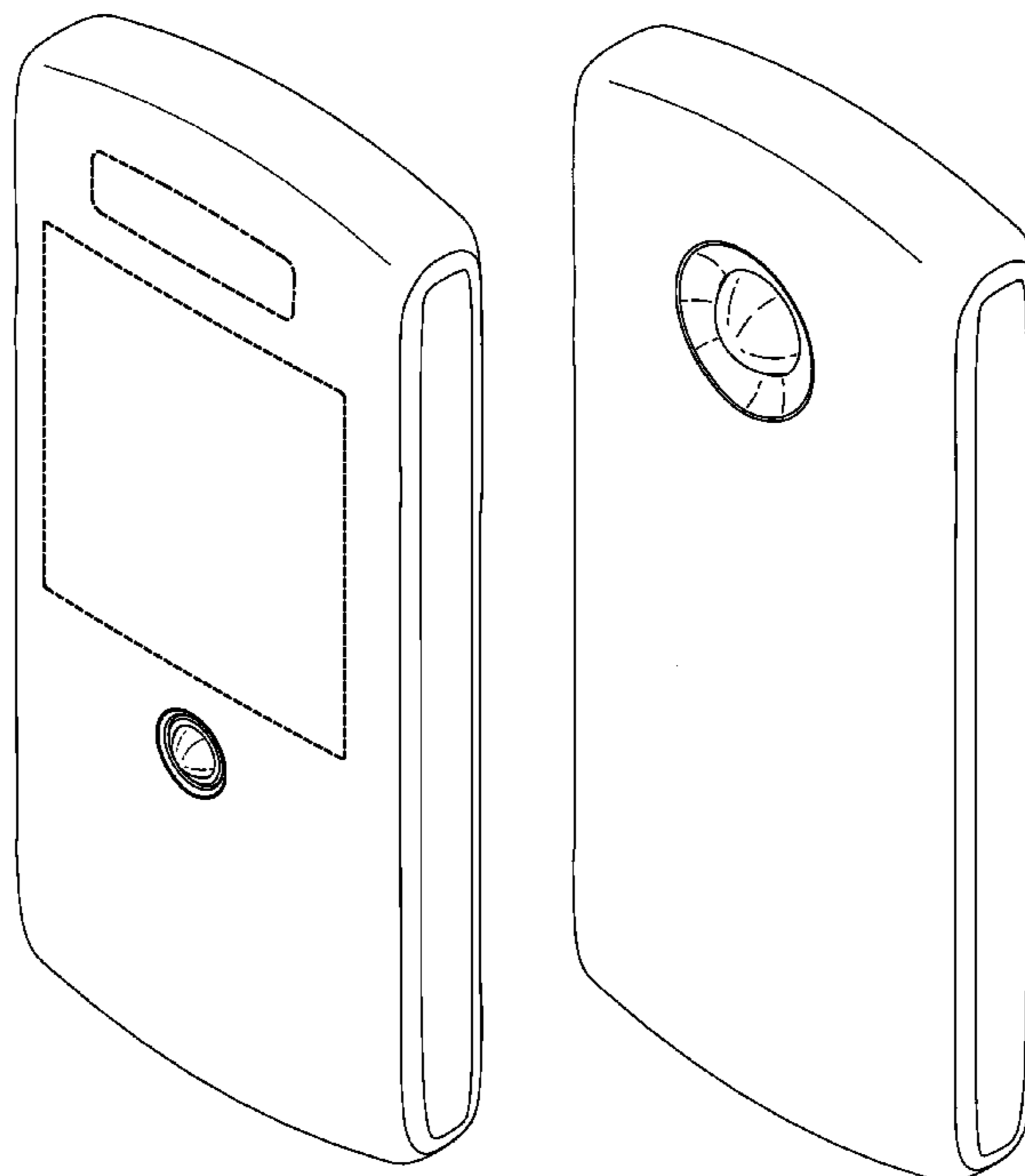

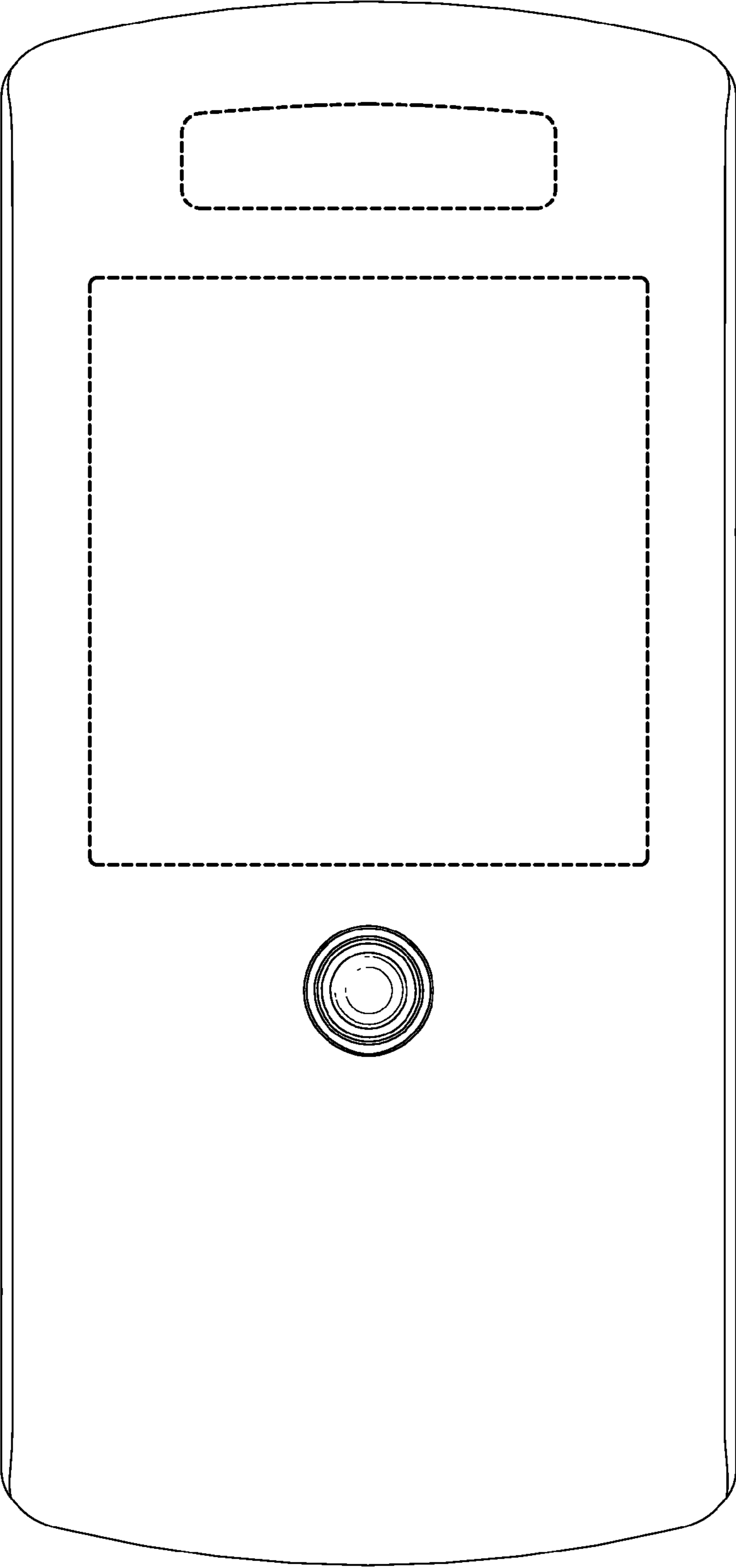
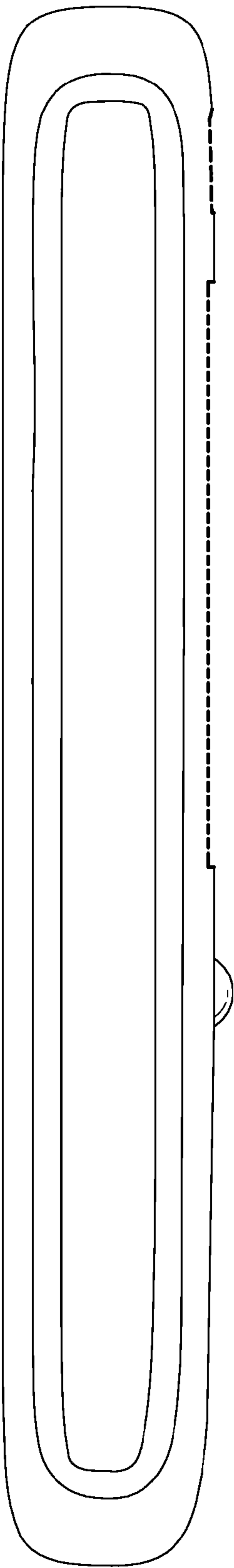
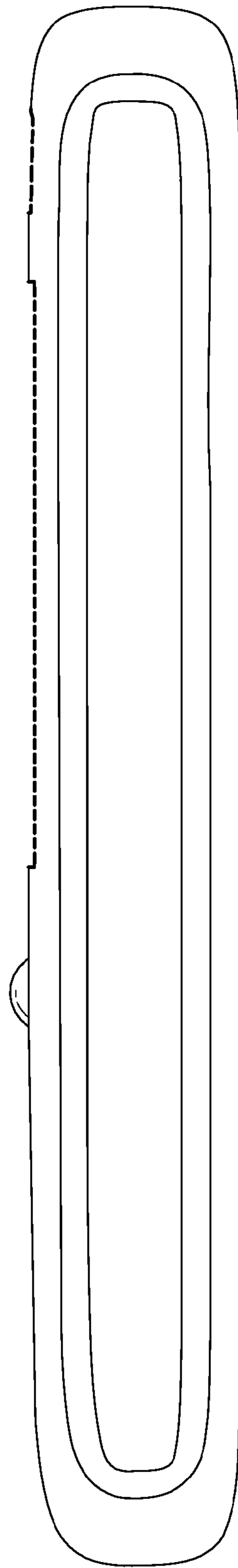

FIG. 1



*FIG. 2*



*FIG. 3*

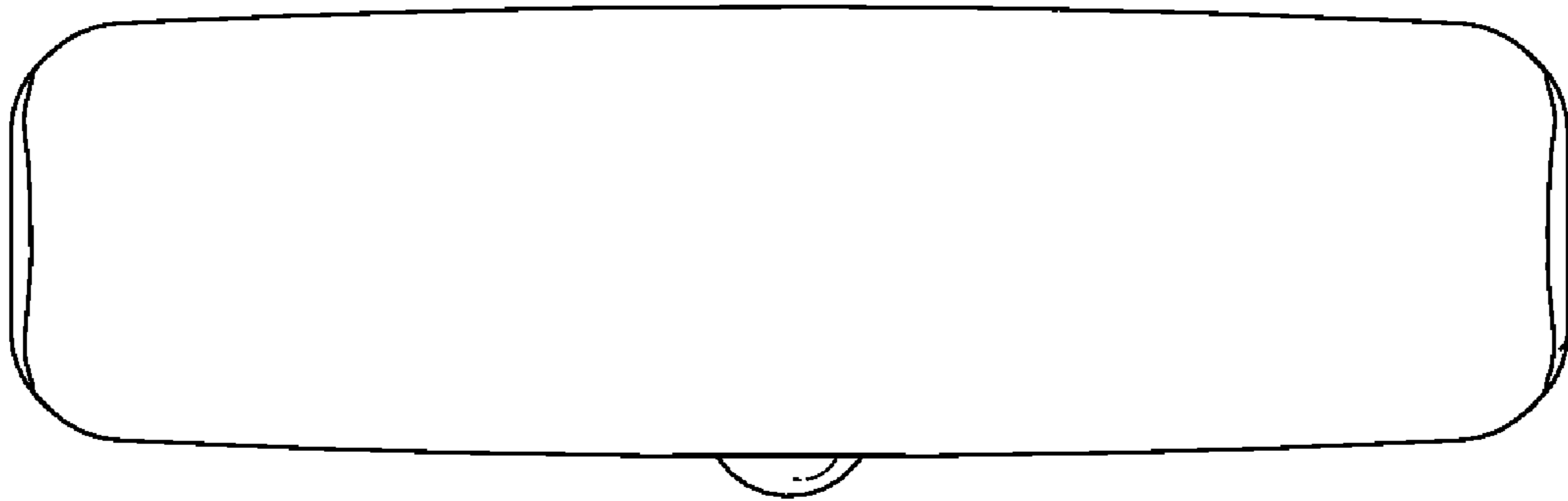

*FIG. 4*

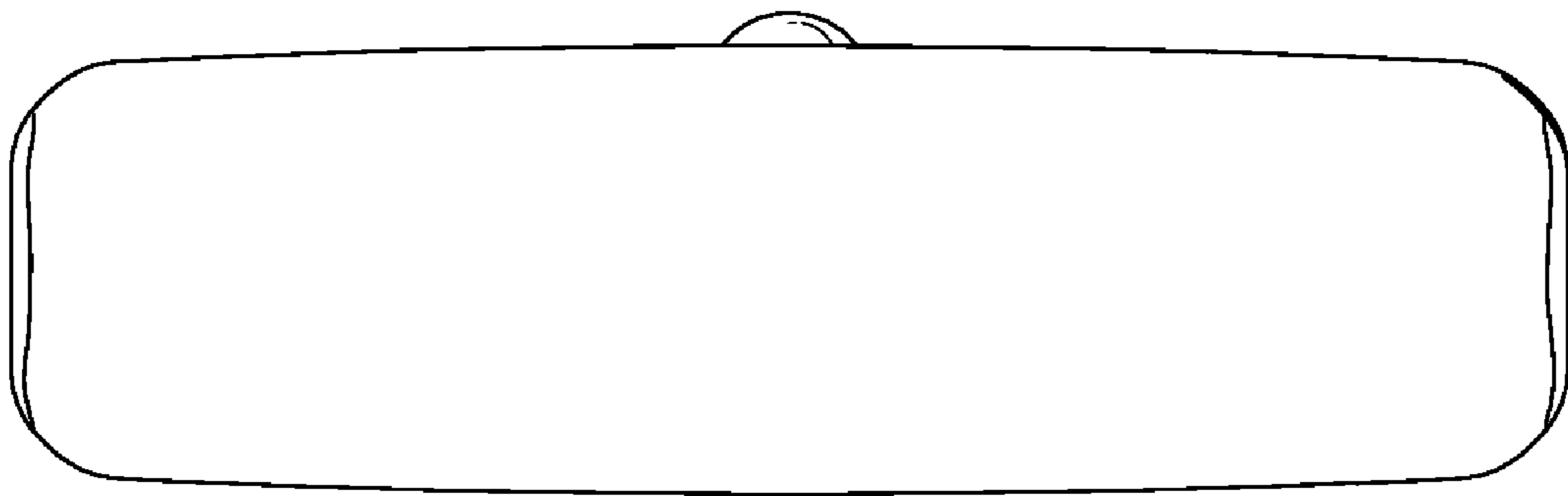

*FIG. 5*

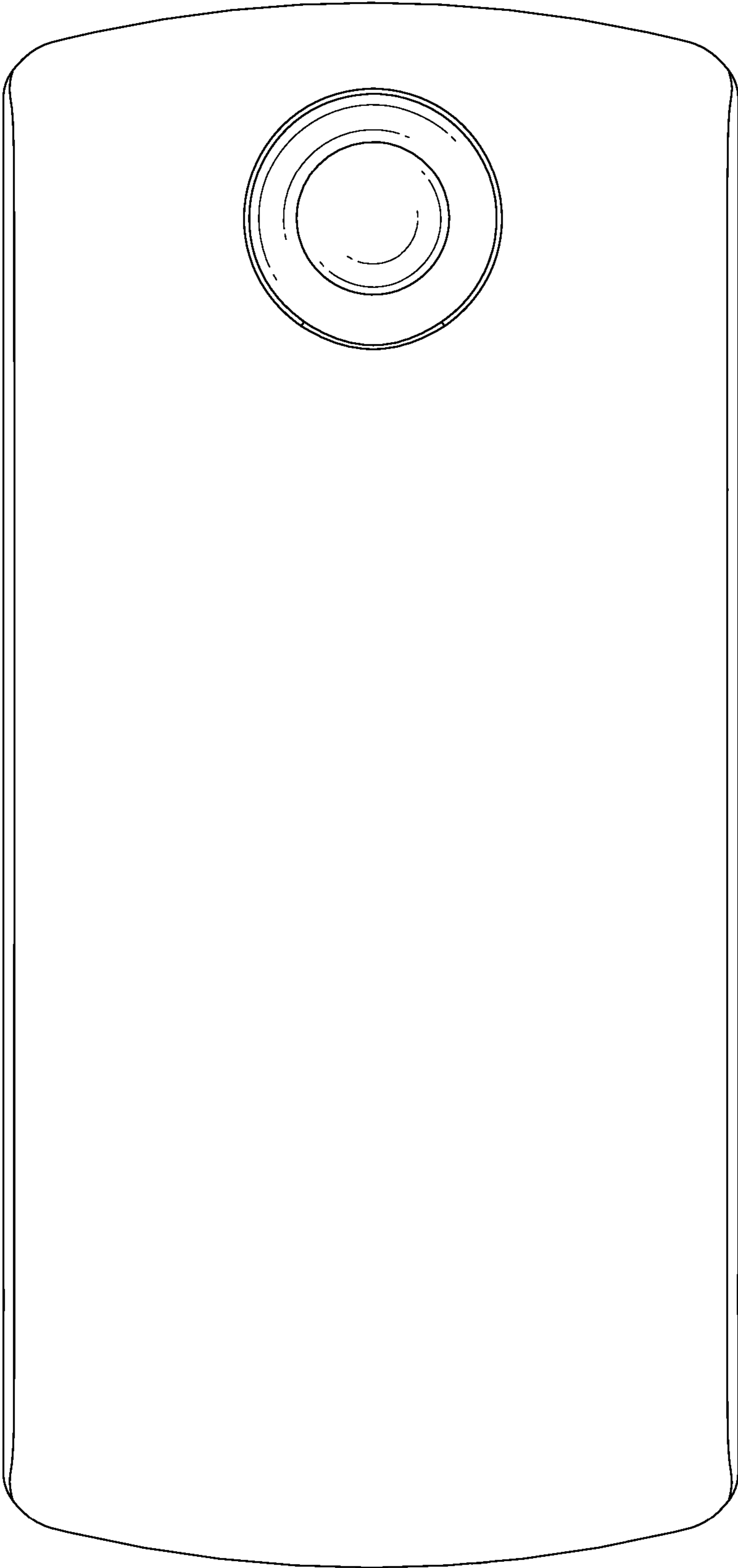

*FIG. 6*

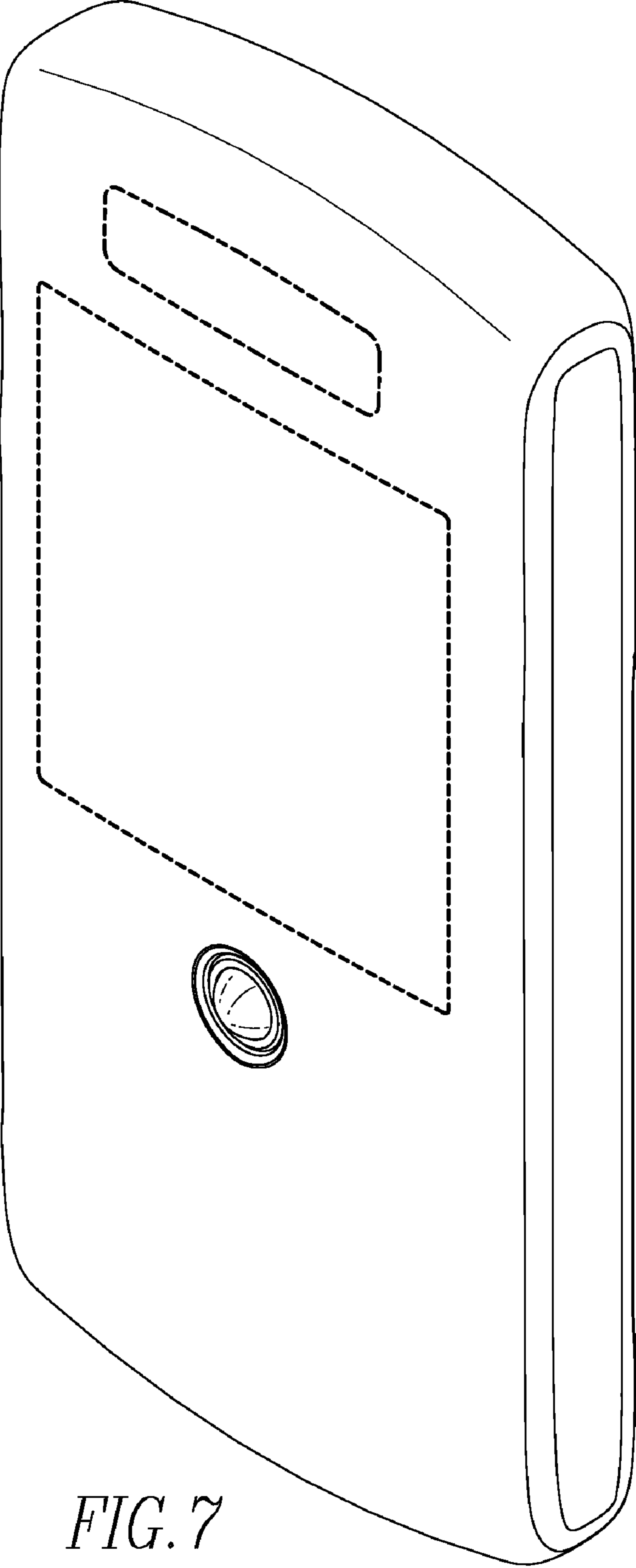
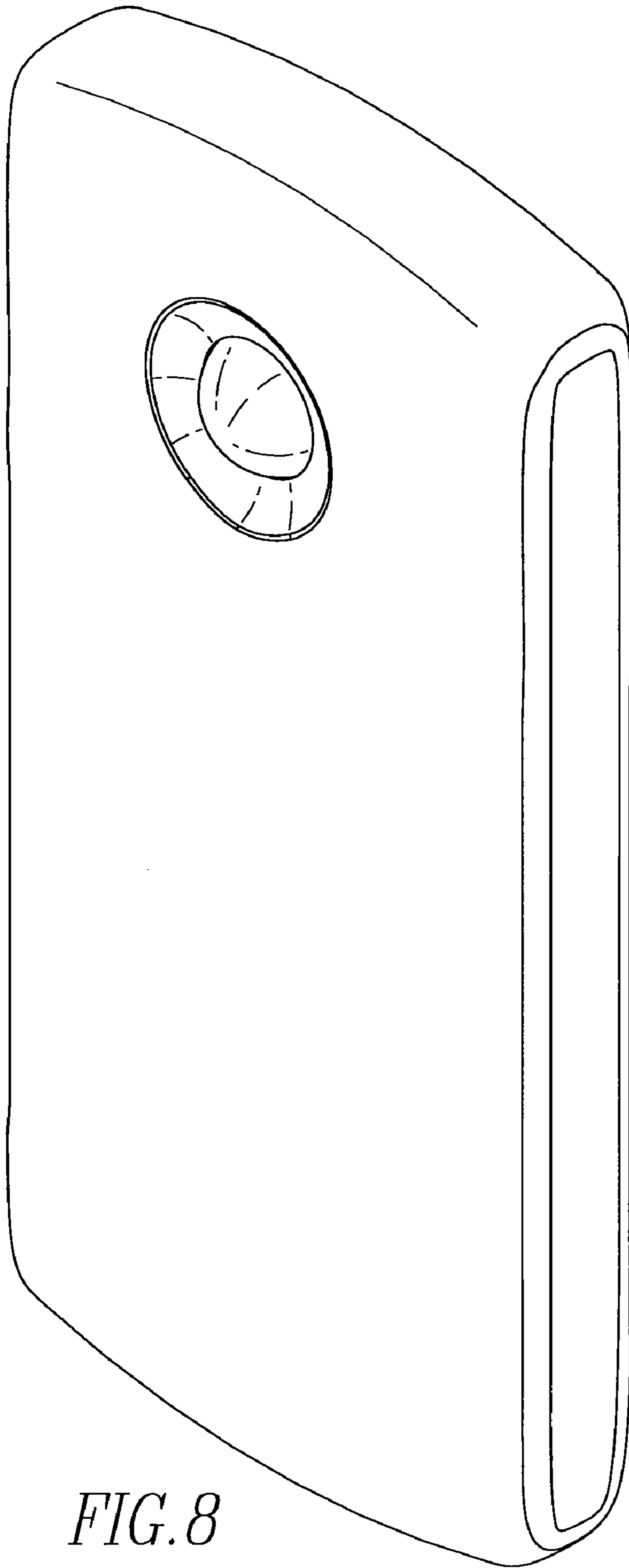

FIG. 7



*FIG. 8*