

US00D576978S

(12) **United States Design Patent**
Kawasaki

(10) **Patent No.:** **US D576,978 S**
(45) **Date of Patent:** **** Sep. 16, 2008**

(54) **DISC PLAYER**

D531,606 S * 11/2006 Johansson et al. D14/136
D539,262 S 3/2007 Hyodo
D544,856 S 6/2007 Hyodo

(75) Inventor: **Masato Kawasaki**, Tokyo (JP)

(73) Assignee: **Sony Corporation**, Tokyo (JP)

(**) Term: **14 Years**

(21) Appl. No.: **29/287,479**

(22) Filed: **Aug. 14, 2007**

(30) **Foreign Application Priority Data**

May 16, 2007 (JP) D2007-012872

(51) **LOC (8) Cl.** **14-01**

(52) **U.S. Cl.** **D14/136**

(58) **Field of Classification Search** D14/135-136,
D14/156-157, 167-168, 198, 188, 217, 257,
D14/258, 445; 360/99.02, 137, 99.07; 369/75.11,
369/75.21, 77.21, 77.11; 720/612, 619, 647,
720/655; 455/344, 347-351

See application file for complete search history.

(56) **References Cited**

U.S. PATENT DOCUMENTS

D437,303 S 2/2001 Hibino
D488,798 S 4/2004 Ishii et al.
D490,796 S * 6/2004 Allen D14/156
D503,693 S 4/2005 Tejima
D512,974 S * 12/2005 Nasrallah D14/136
D513,242 S 12/2005 Tejima

OTHER PUBLICATIONS

Web page, "News release for DRXS50U", http://news.sel.sony.com/en/press_room/b2b/storage_solutions/release/24990.html, 5 sheets, Sony Electronics Inc. (Jun. 2007).

Web page, "DRXS50U", <http://www.learningcenter.sony.us/DiscBurners/DVDBurners>, 4 sheets, Sony Electronics Inc., (Jun. 2007).

* cited by examiner

Primary Examiner—Nanda Bondade

(74) *Attorney, Agent, or Firm*—Rader, Fishman, Grauer, PLLC

(57) **CLAIM**

The ornamental design for a disc player, as shown.

DESCRIPTION

FIG. 1 is a perspective view of a disc player showing my new design;

FIG. 2 is a front elevational view thereof;

FIG. 3 is a rear elevational view thereof;

FIG. 4 is a left side elevational view thereof;

FIG. 5 is a right side elevational view thereof;

FIG. 6 is a top plan view thereof; and,

FIG. 7 is a bottom plan view thereof.

1 Claim, 7 Drawing Sheets

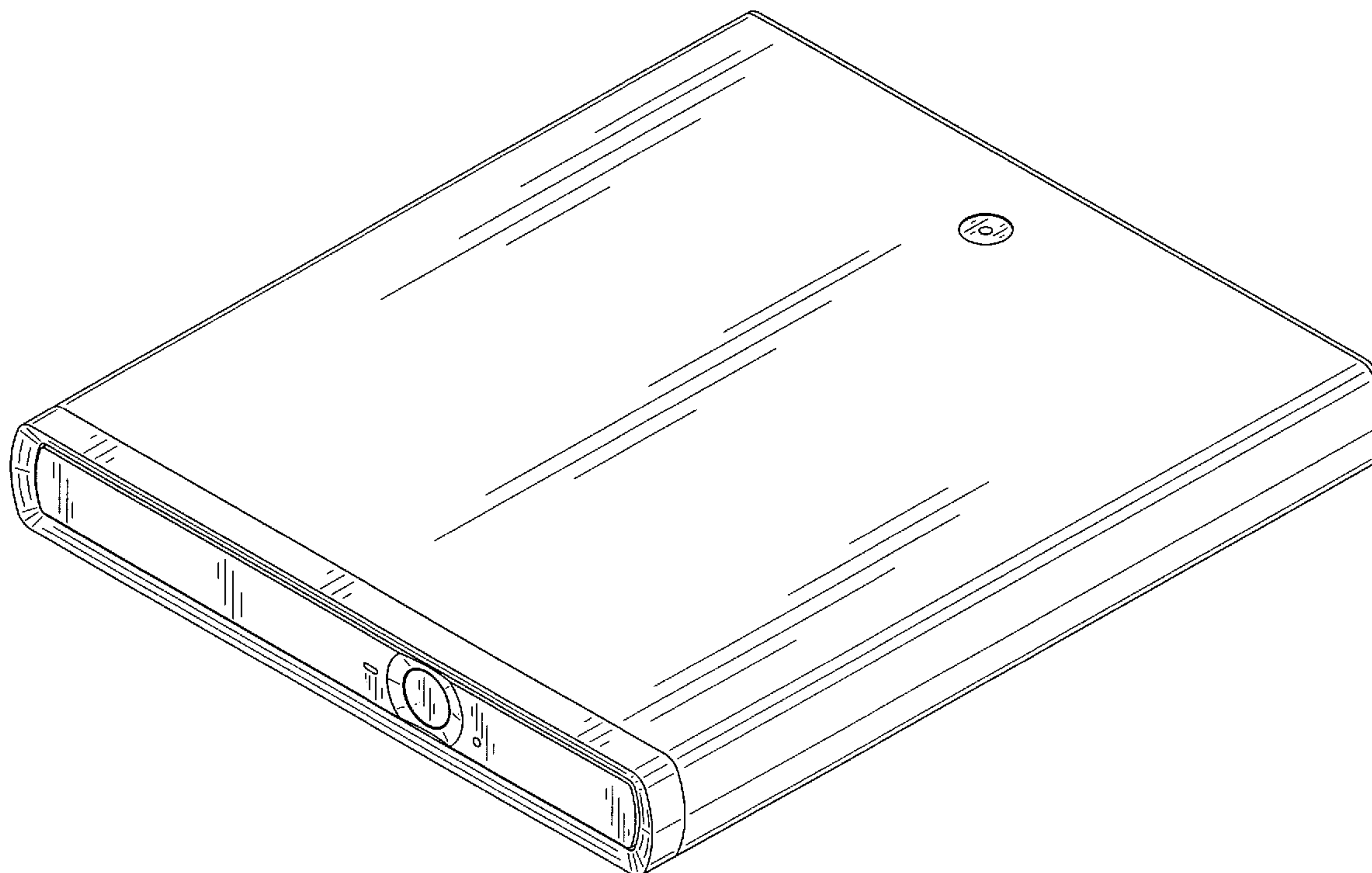

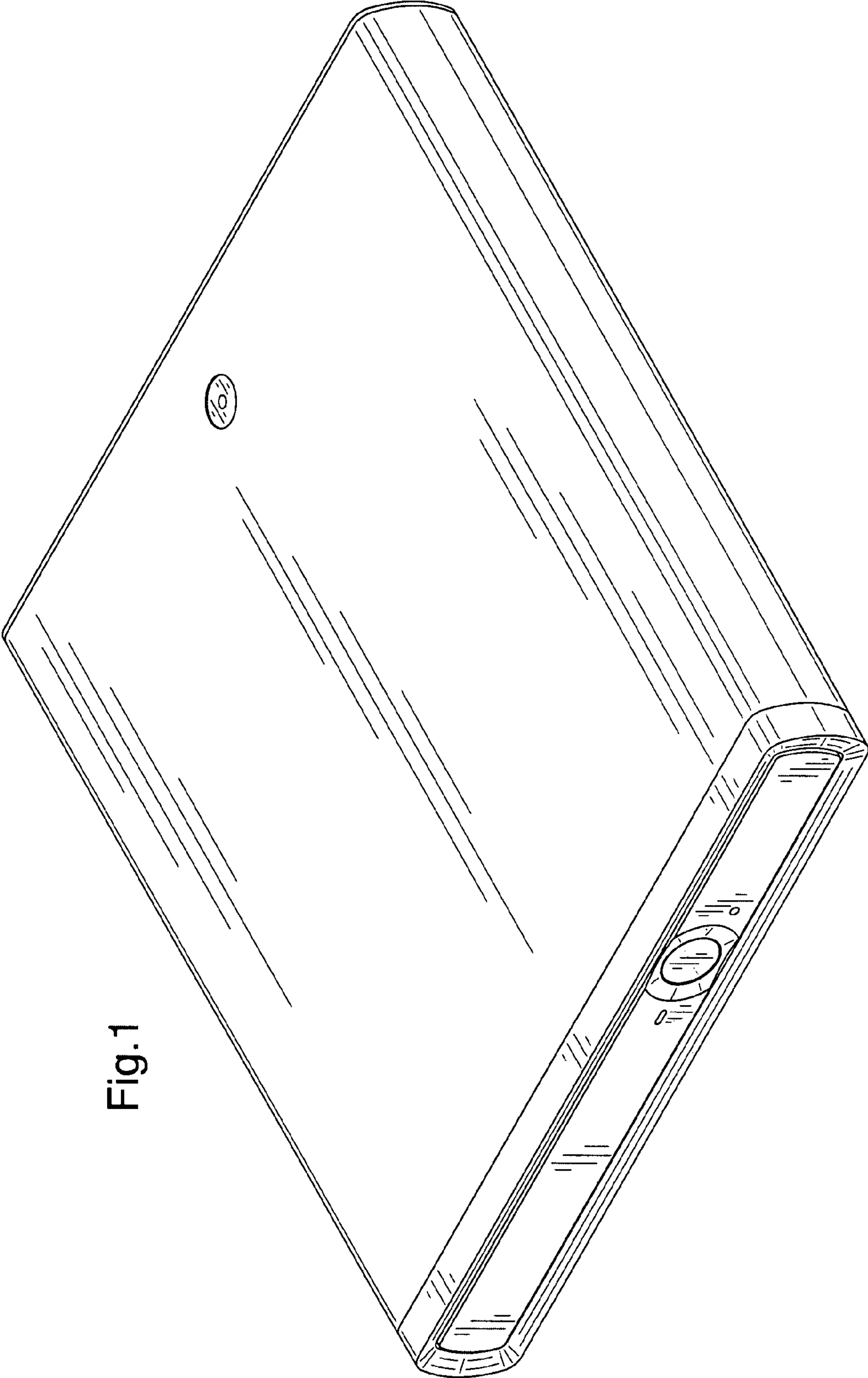

Fig.1

Fig.2

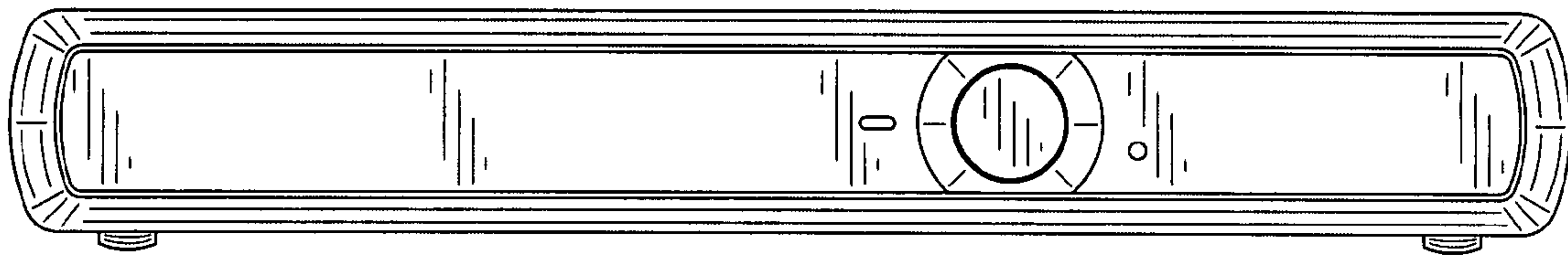

Fig.3

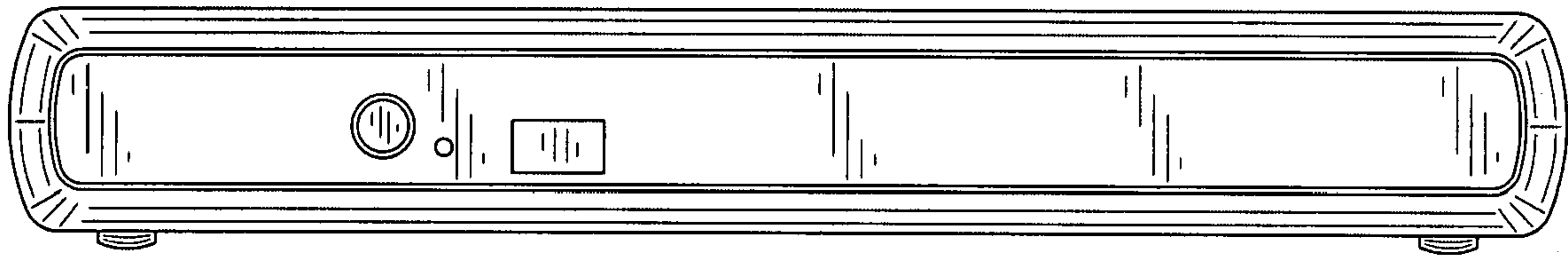

Fig.4

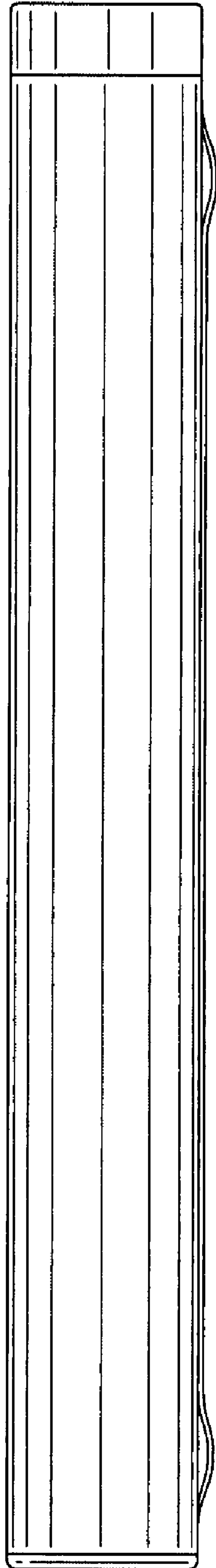

Fig.5

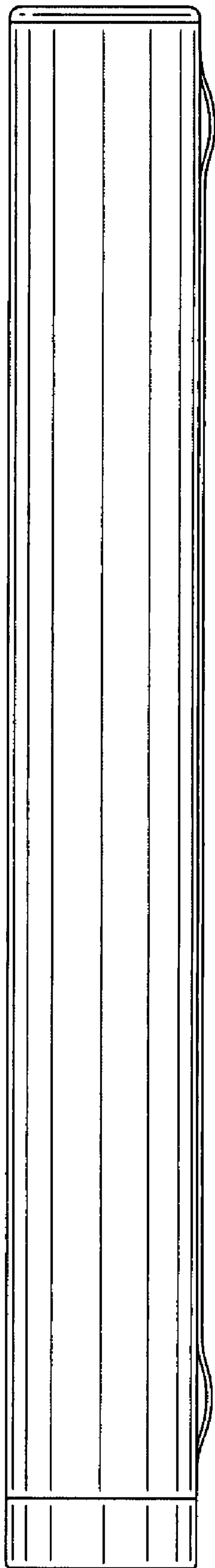

Fig.6

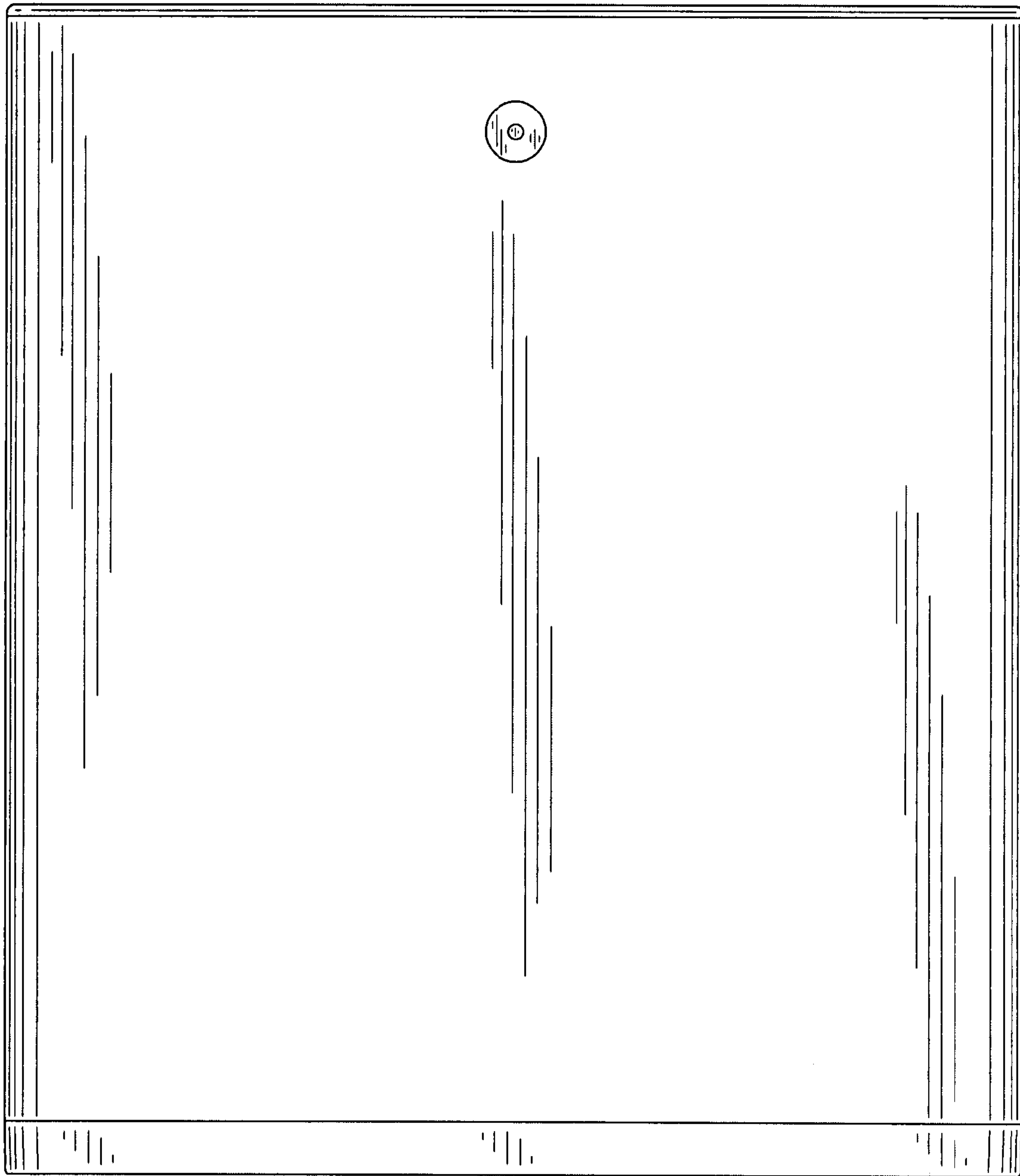

Fig.7

