



US00D576944S

(12) **United States Design Patent**
Wu et al.

(10) **Patent No.:** **US D576,944 S**
(45) **Date of Patent:** **** Sep. 16, 2008**

(54) **CHARGING CONNECTOR**

(75) Inventors: **Yin Lung Wu**, Tu-Cheng (TW); **Mei Chuan Yang**, Tu-Cheng (TW); **Chung Hsin Hung**, Tu-Cheng (TW)

(73) Assignee: **Cheng Uei Precision Industry Co., Ltd.**, Taipei Hsien (TW)

(**) Term: **14 Years**

(21) Appl. No.: **29/256,384**

(22) Filed: **Mar. 21, 2006**

(51) **LOC (8) Cl.** **13-03**

(52) **U.S. Cl.** **D13/133**

(58) **Field of Classification Search** D13/133,
D13/146, 147, 154, 184, 199; 439/108, 352,
439/354, 357, 358, 374, 567, 607, 608, 609,
439/610, 656, 676, 680

See application file for complete search history.

(56) **References Cited**

U.S. PATENT DOCUMENTS

| | | | |
|---------------|---------|----------------------|---------|
| D196,111 S * | 8/1963 | Krehbiel | D13/147 |
| D310,993 S * | 10/1990 | Ohkura et al. | D13/146 |
| D317,148 S * | 5/1991 | Kozono et al. | D13/146 |
| 5,141,452 A * | 8/1992 | Yoneda et al. | 439/595 |
| D405,053 S * | 2/1999 | Tan et al. | D13/147 |
| D413,101 S * | 8/1999 | Avery et al. | D13/147 |
| D425,869 S * | 5/2000 | Yokomizo et al. | D13/147 |

| | | | |
|----------------|---------|-------------------|---------|
| 6,607,308 B2 * | 8/2003 | Dair et al. | 385/92 |
| D479,199 S * | 9/2003 | Jones et al. | D13/147 |
| D529,444 S * | 10/2006 | Kudo | D13/147 |
| D531,960 S * | 11/2006 | Kondas | D13/147 |

* cited by examiner

Primary Examiner—Daniel D Bui

(74) *Attorney, Agent, or Firm*—Rosenberg, Klein & Lee

(57) **CLAIM**

The ornamental design for a charging connector, as shown and described.

DESCRIPTION

FIG. 1 is a perspective view of a charging connector showing our new design;

FIG. 2 is a front elevational view thereof;

FIG. 3 is a rear elevational view thereof;

FIG. 4 is a left side elevational view thereof;

FIG. 5 is a right side elevational view thereof;

FIG. 6 is a top plan view thereof;

FIG. 7 is a bottom plan view thereof; and,

FIG. 8 is a perspective view showing the charging connector connecting to two cables.

The broken line in FIGS. 7 and 8 is included to show unclaimed subject matter only and forms no part of the claimed design.

1 Claim, 8 Drawing Sheets

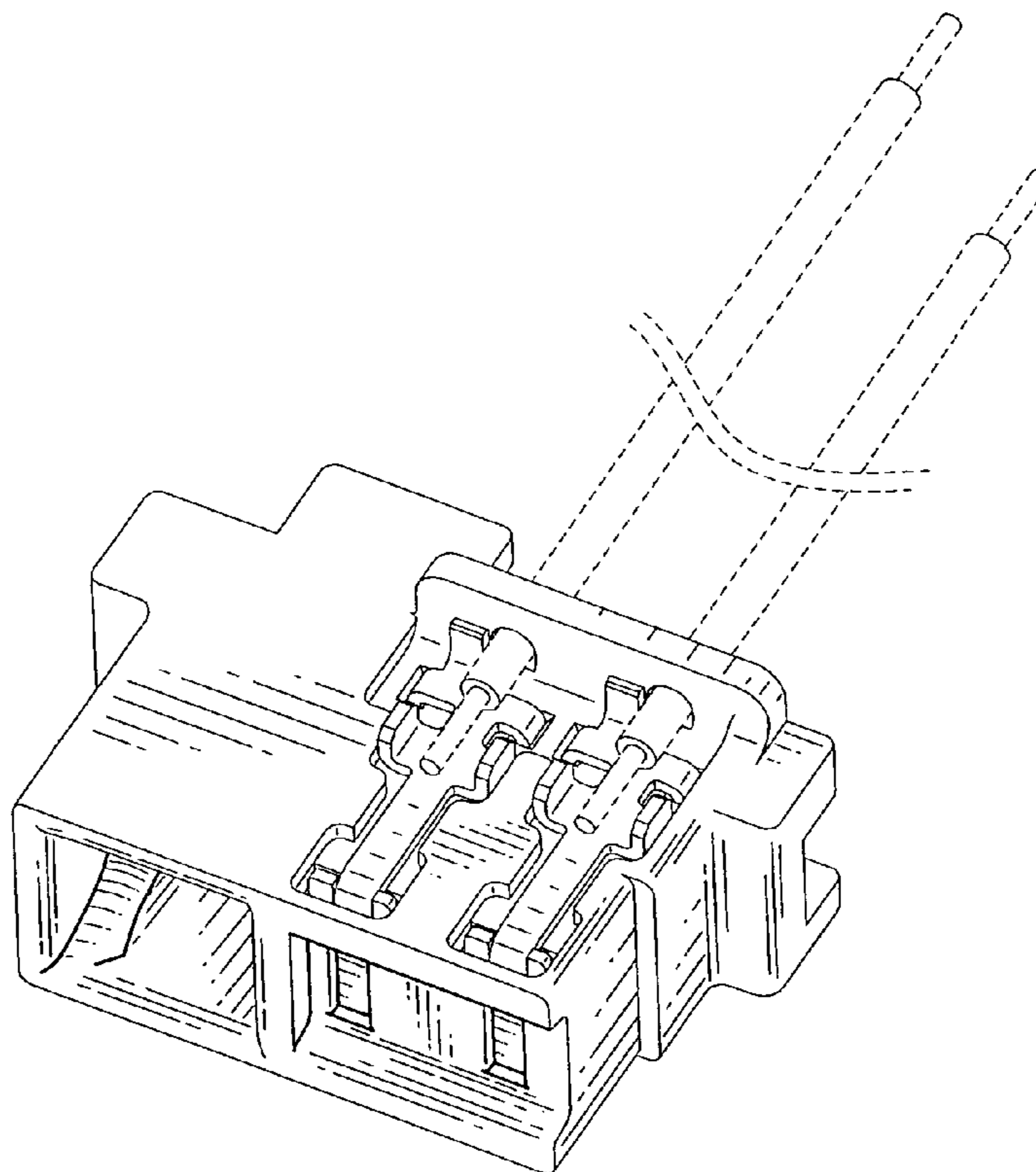

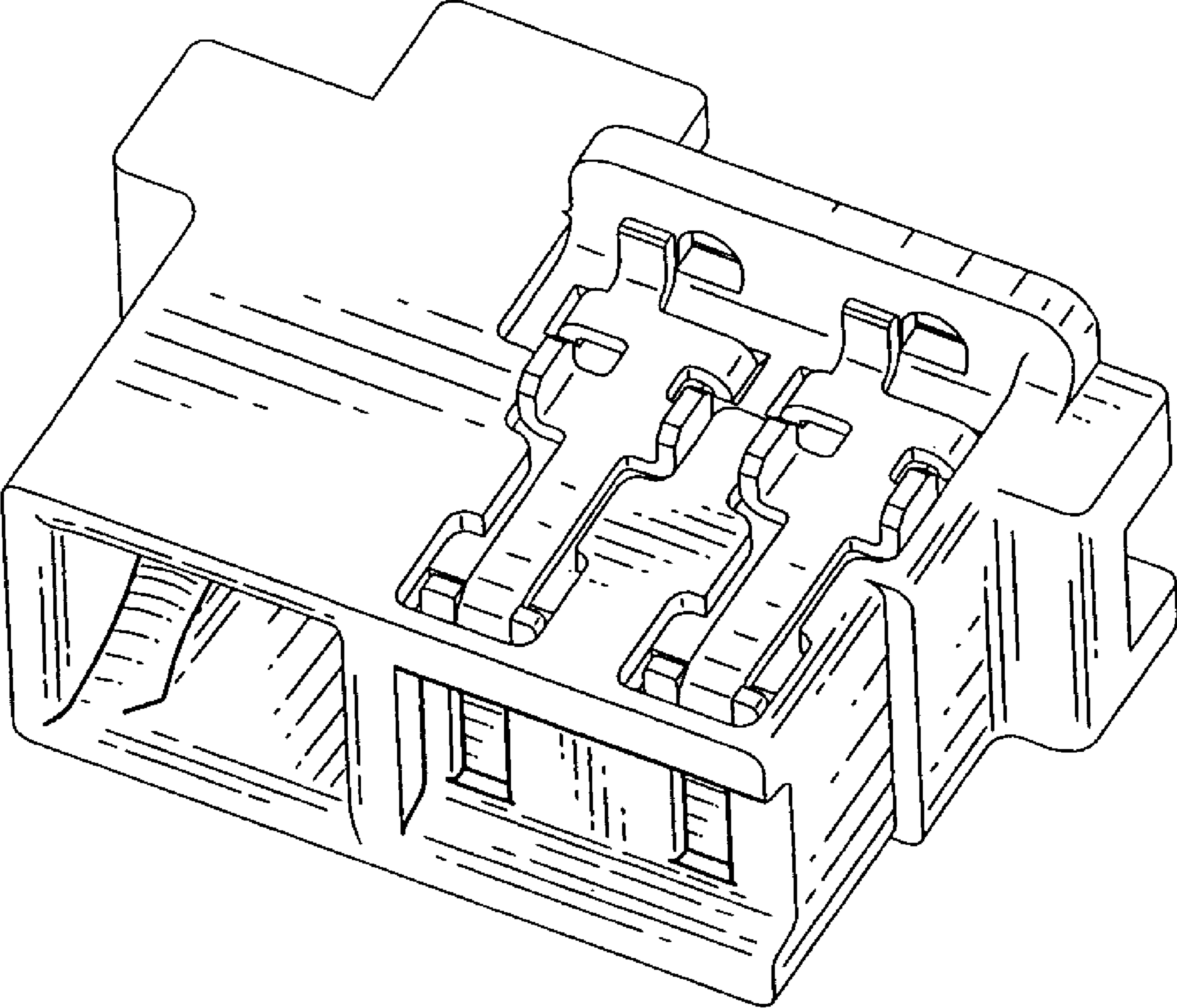

FIG. 1

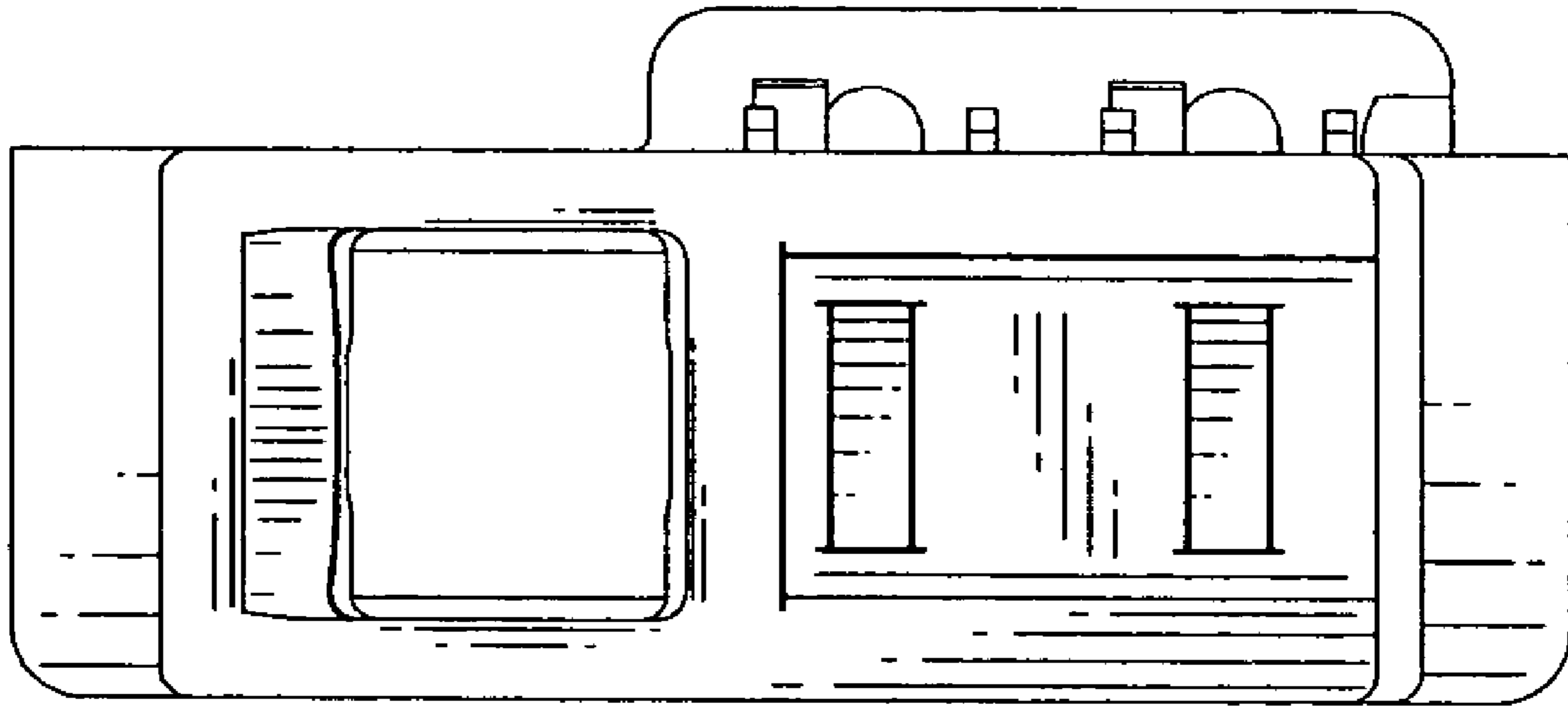

FIG. 2

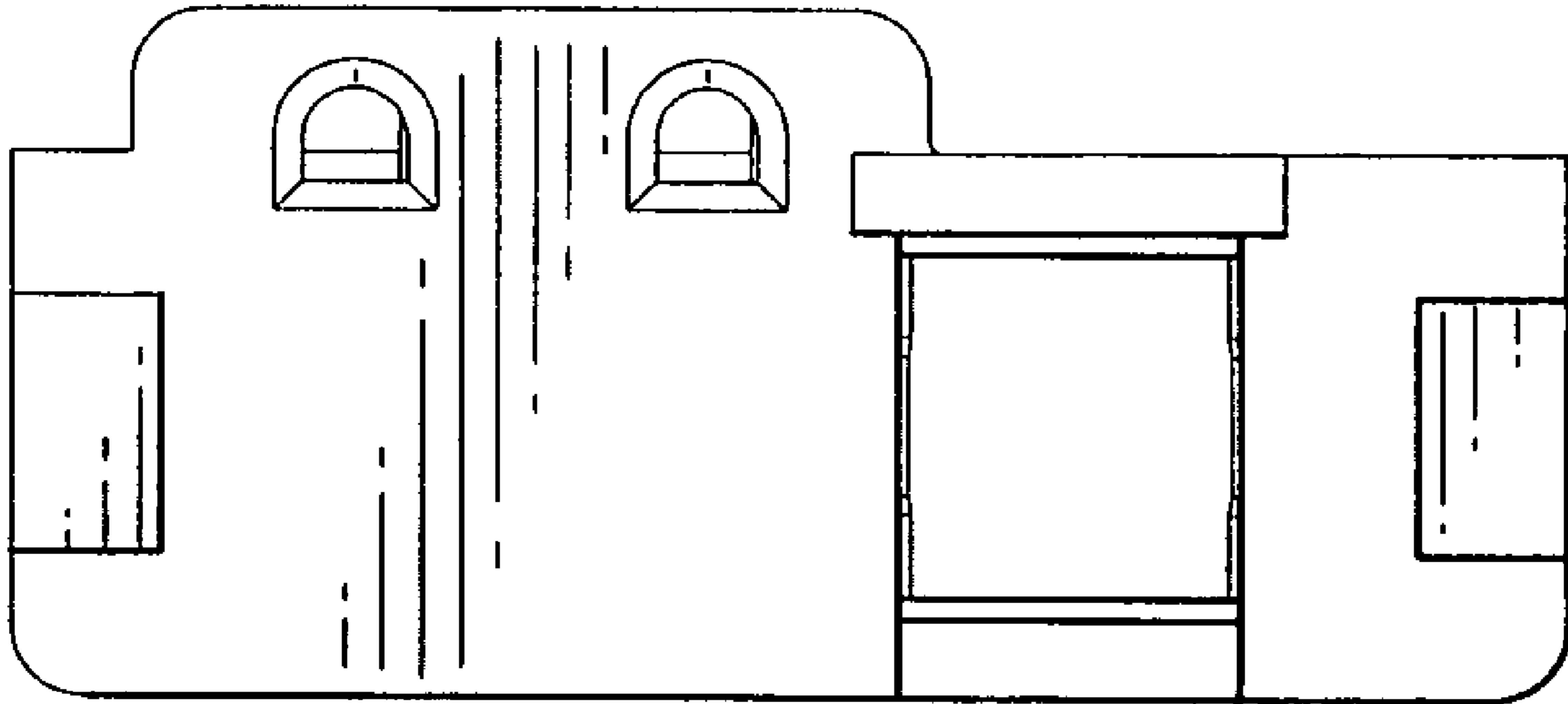

FIG. 3

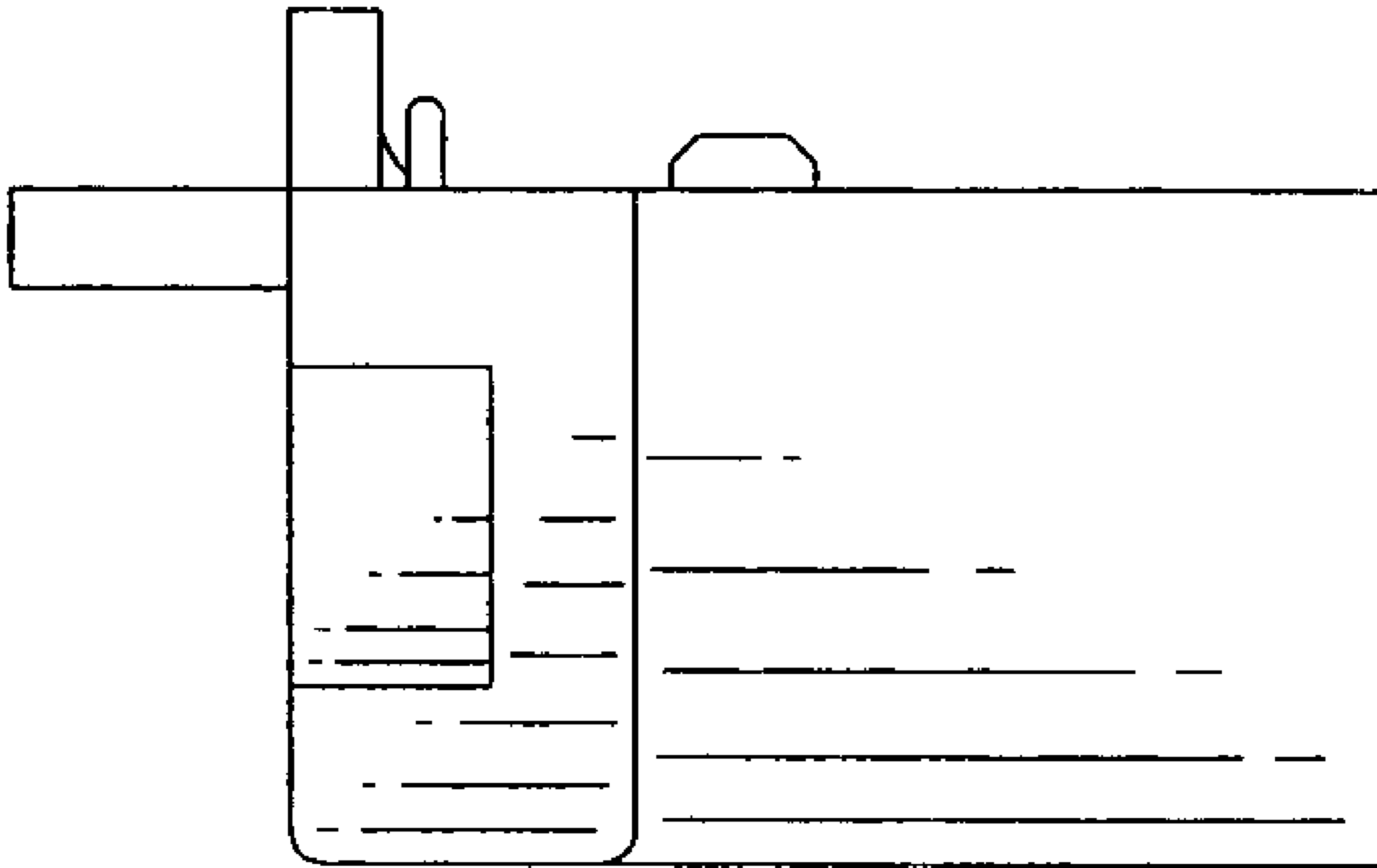

FIG. 4

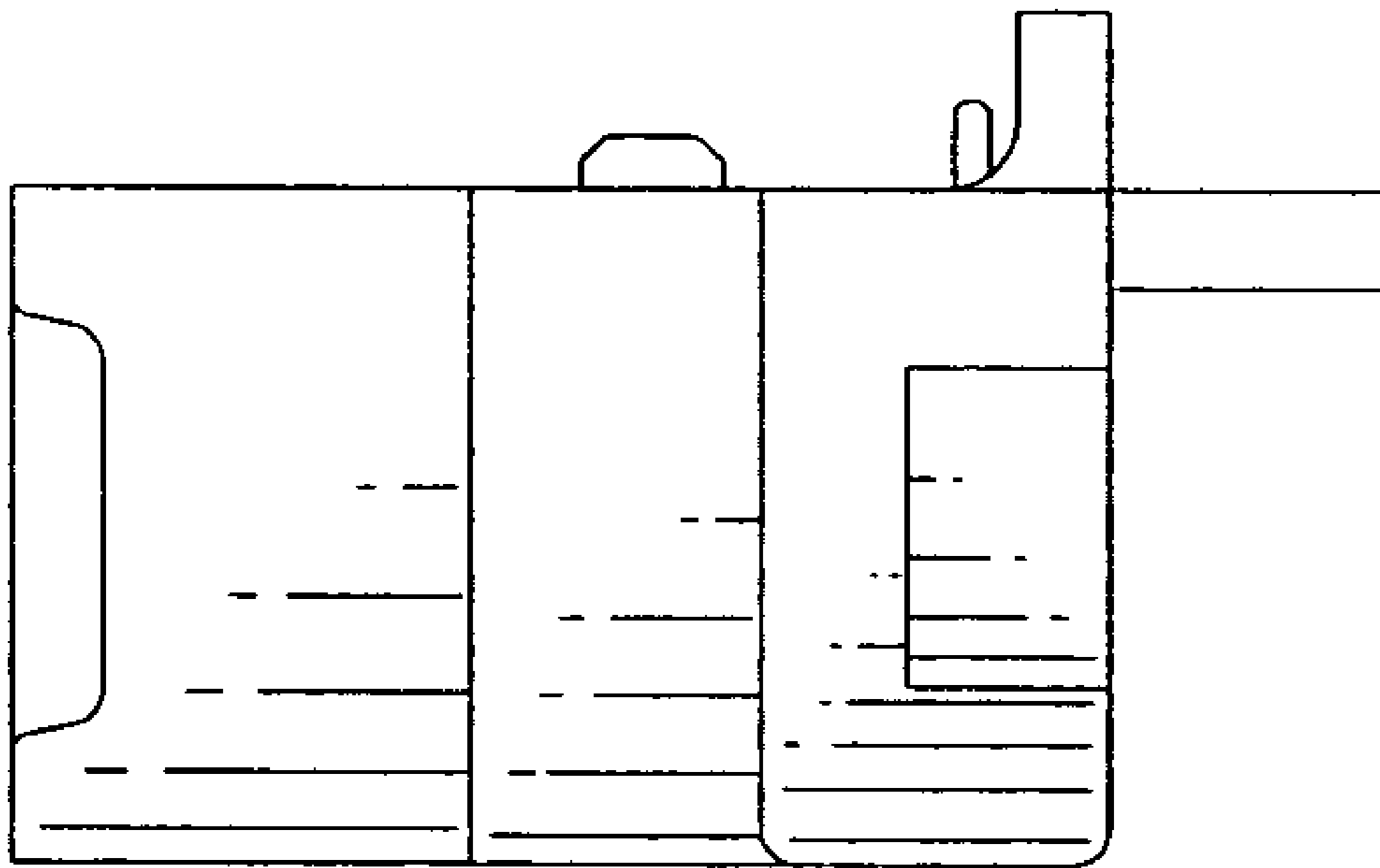

FIG. 5

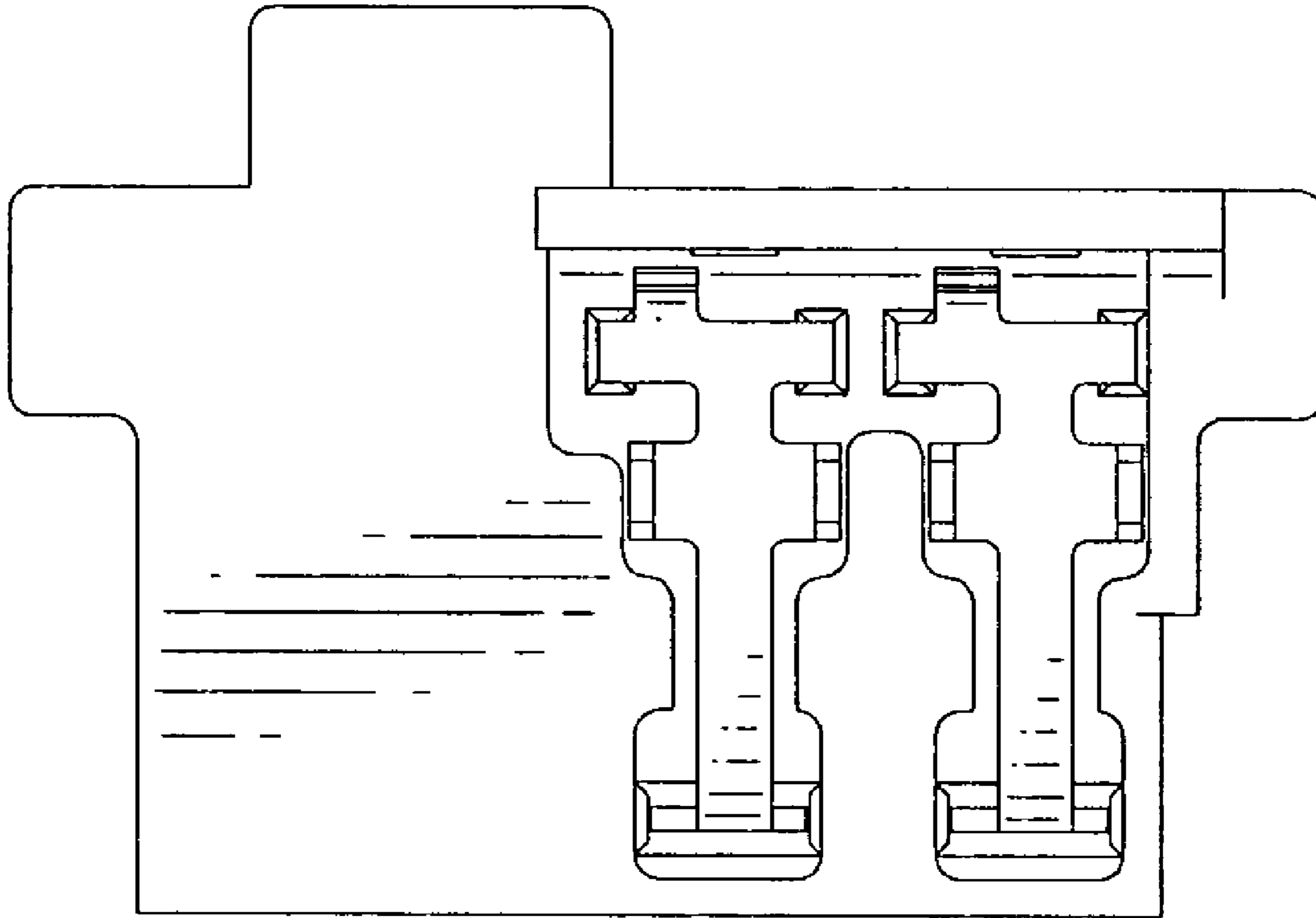

FIG. 6

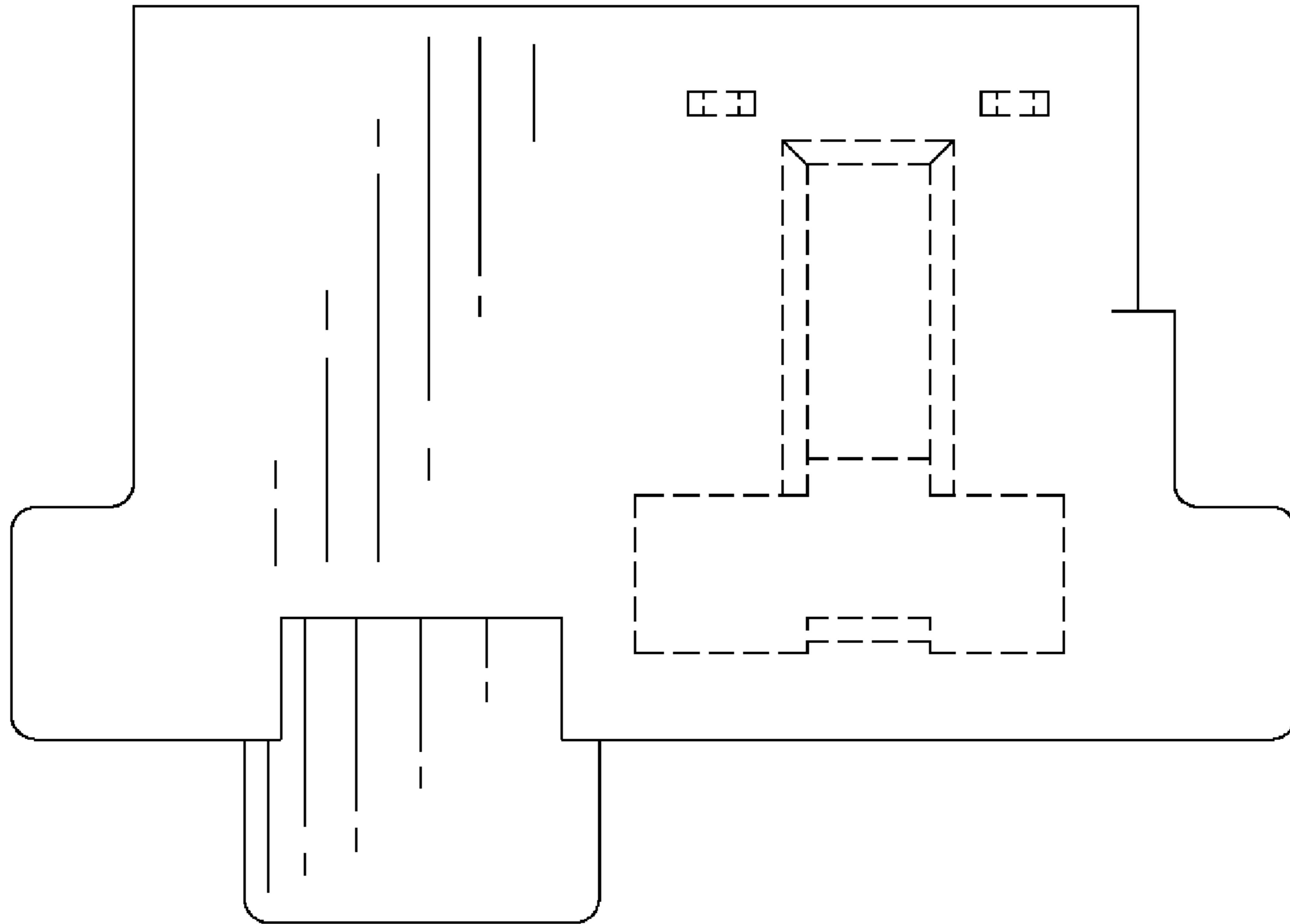

FIG. 7

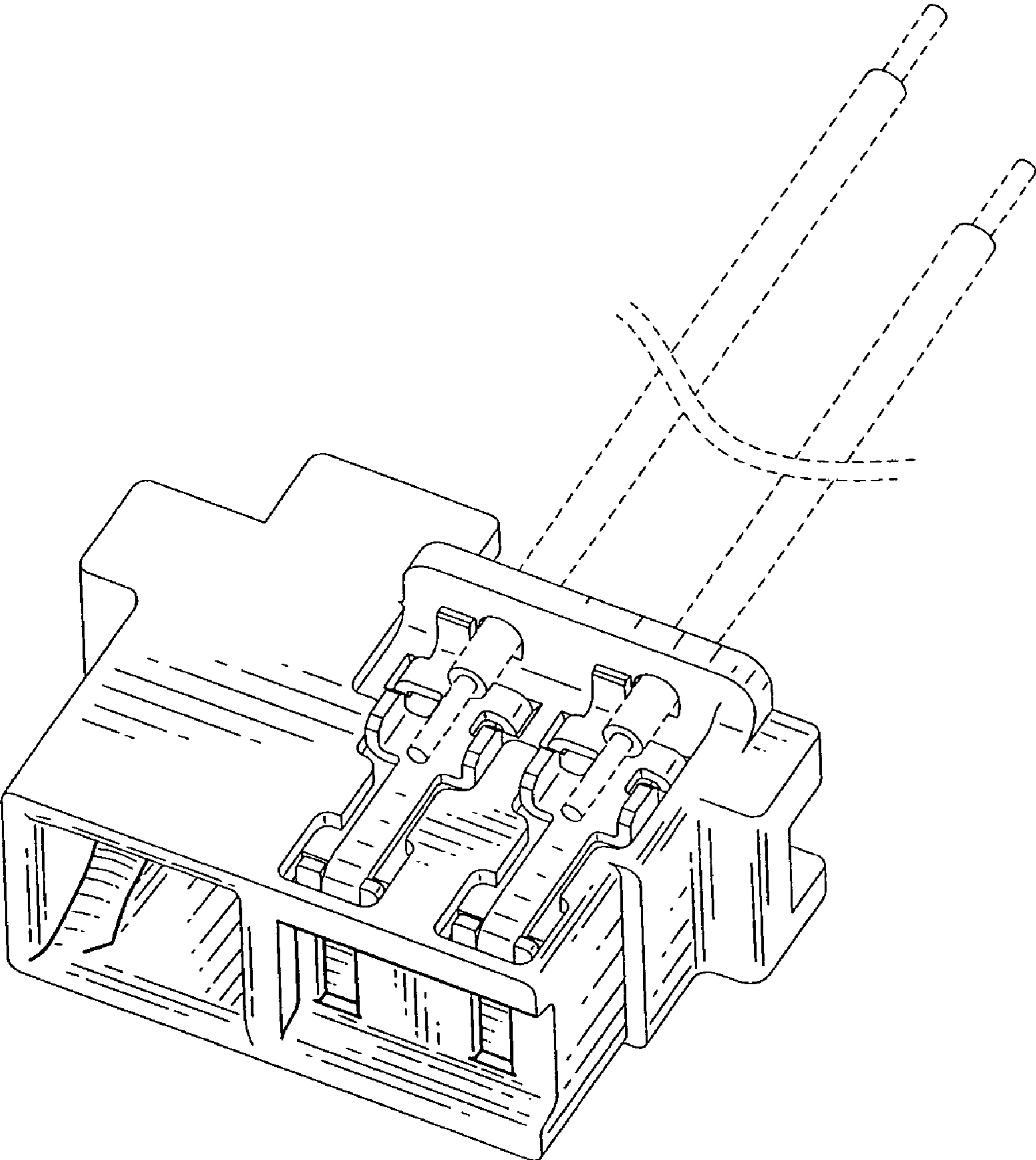

FIG. 8