



US00D576920S

(12) **United States Design Patent**  
**Yang**

(10) **Patent No.:** **US D576,920 S**  
(45) **Date of Patent:** **\*\* Sep. 16, 2008**

(54) **ELECTRIC SCOOTER**

(76) Inventor: **Tai-Her Yang**, 6F-5, No. 250, Sec. 4,  
Chung Hsiao E. Rd., Taipei (TW) 10692

(\*\*) Term: **14 Years**

(21) Appl. No.: **29/290,167**

(22) Filed: **Oct. 26, 2007**

(51) **LOC (8) Cl.** ..... **12-12**

(52) **U.S. Cl.** ..... **D12/107; D21/423; D12/128;**  
**D34/15**

(58) **Field of Classification Search** ..... D12/128-133,  
D12/107; 280/62, 647-650, 29, 200, 47.38,  
280/250.1, 259, 642, 658; 297/DIG. 4; 296/65.03,  
296/65.04; 224/409; 135/65-67, 74; 180/208;  
267/5; D21/110, 111, 419; D34/15  
See application file for complete search history.

(56) **References Cited**

**U.S. PATENT DOCUMENTS**

D403,279 S \* 12/1998 Wu ..... D12/131  
D479,496 S \* 9/2003 Tsai et al. .... D12/128  
D488,409 S \* 4/2004 Tsai ..... D12/128

D509,774 S \* 9/2005 Chen ..... D12/131  
D511,720 S \* 11/2005 Chen ..... D12/128  
D517,456 S \* 3/2006 Wu et al. .... D12/131  
D530,650 S \* 10/2006 Azuma et al. .... D12/131

\* cited by examiner

*Primary Examiner*—Charles A. Rademaker

*Assistant Examiner*—Charles D Hanson

(74) *Attorney, Agent, or Firm*—Bacon & Thomas, PLLC

(57) **CLAIM**

The ornamental design for an electric scooter, as shown and described.

**DESCRIPTION**

FIG. 1 is a right side perspective view of an electric scooter showing my new design;

FIG. 2 is a front view thereof;

FIG. 3 is a rear view thereof;

FIG. 4 is a left side view thereof;

FIG. 5 is a right side view thereof; and,

FIG. 6 is a top plan view thereof.

**1 Claim, 6 Drawing Sheets**

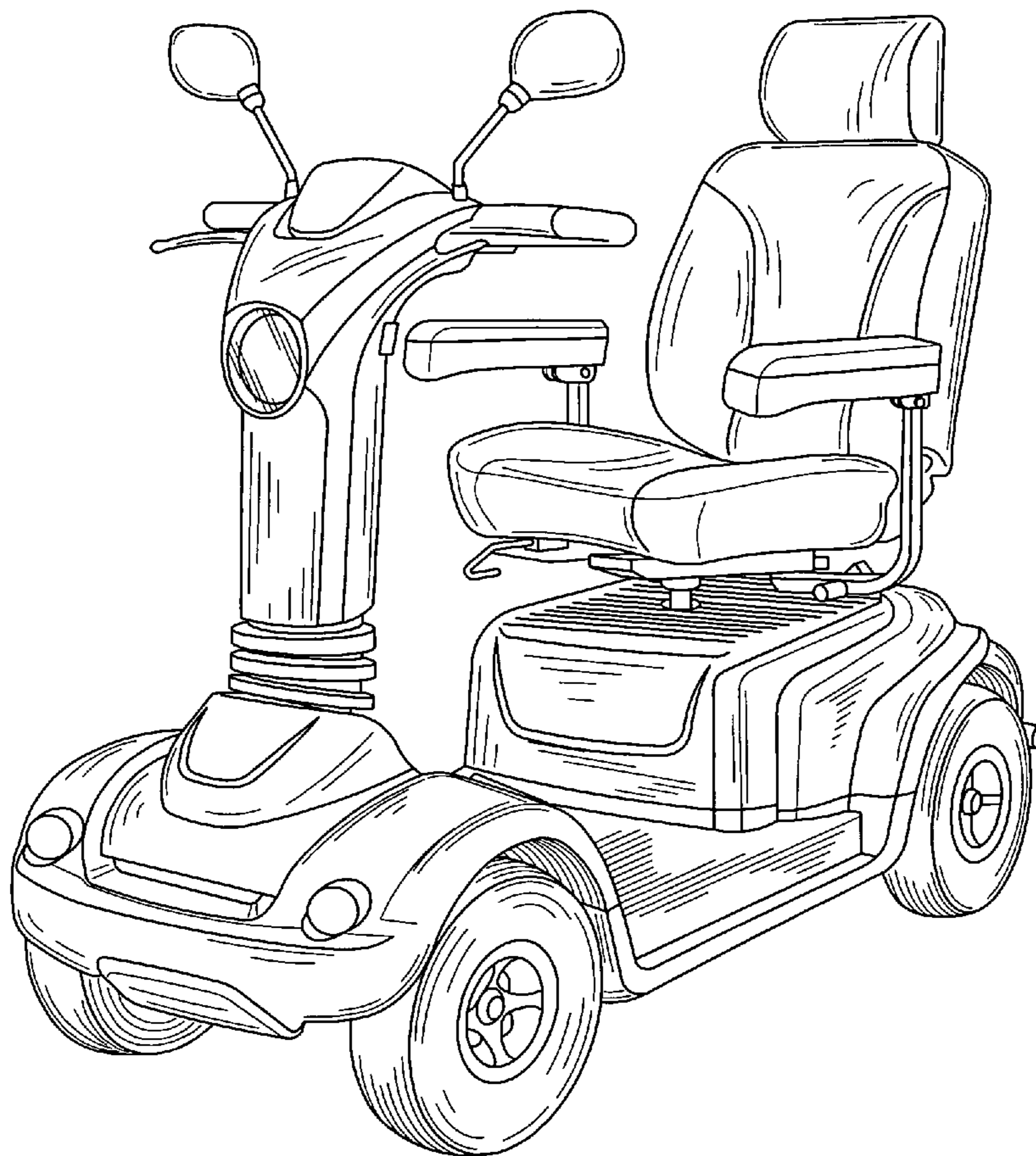

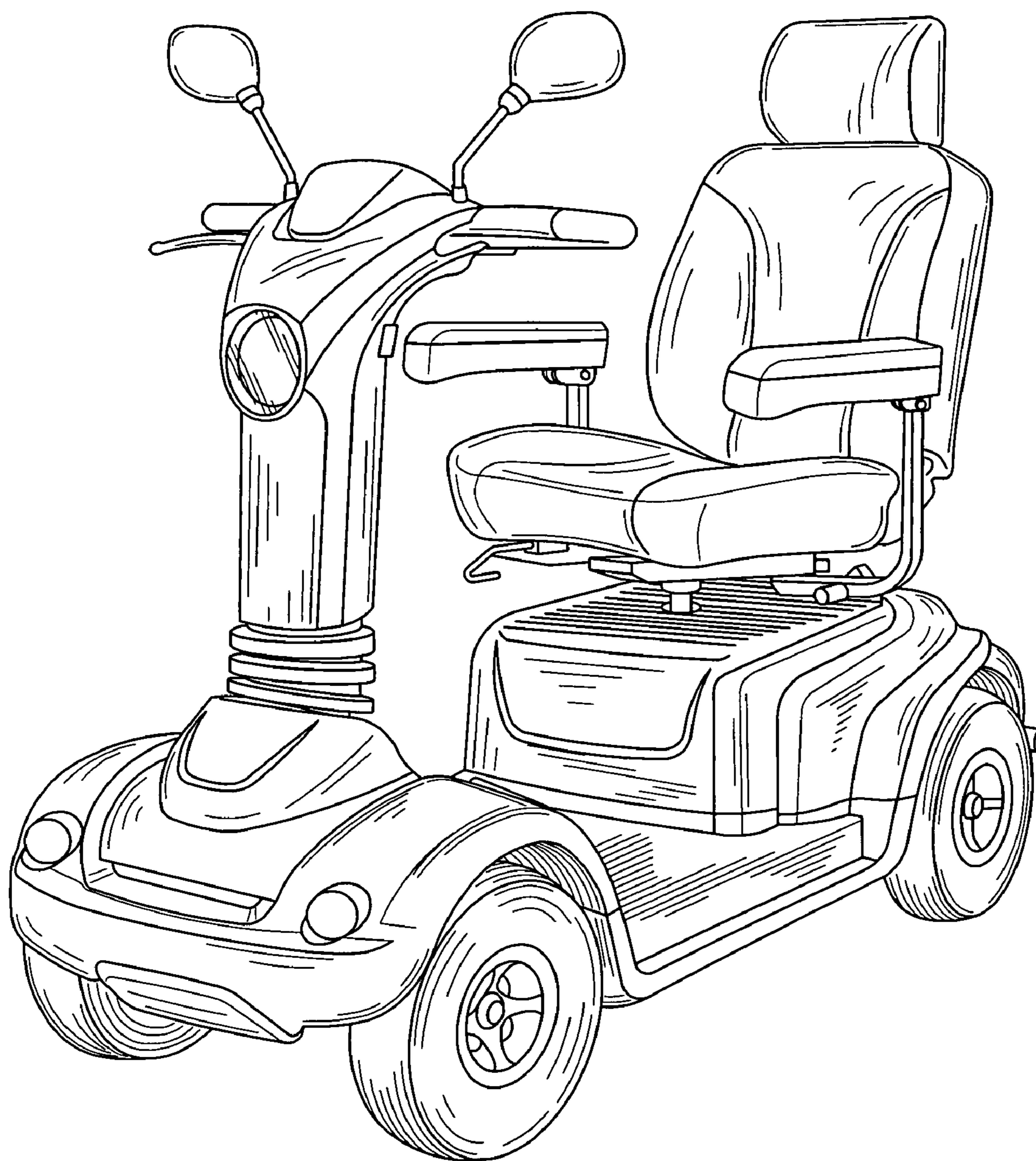

FIG. 1

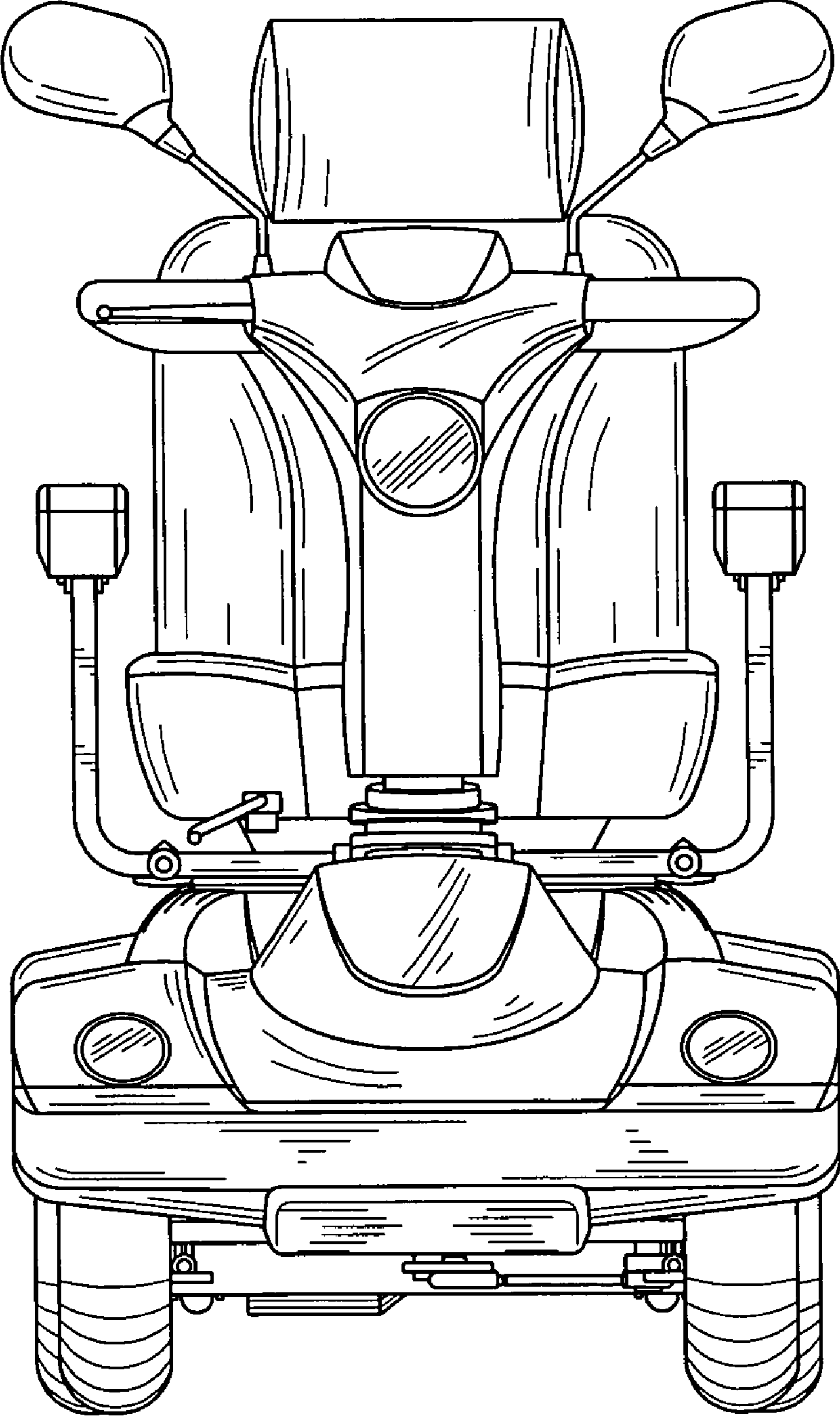

FIG. 2

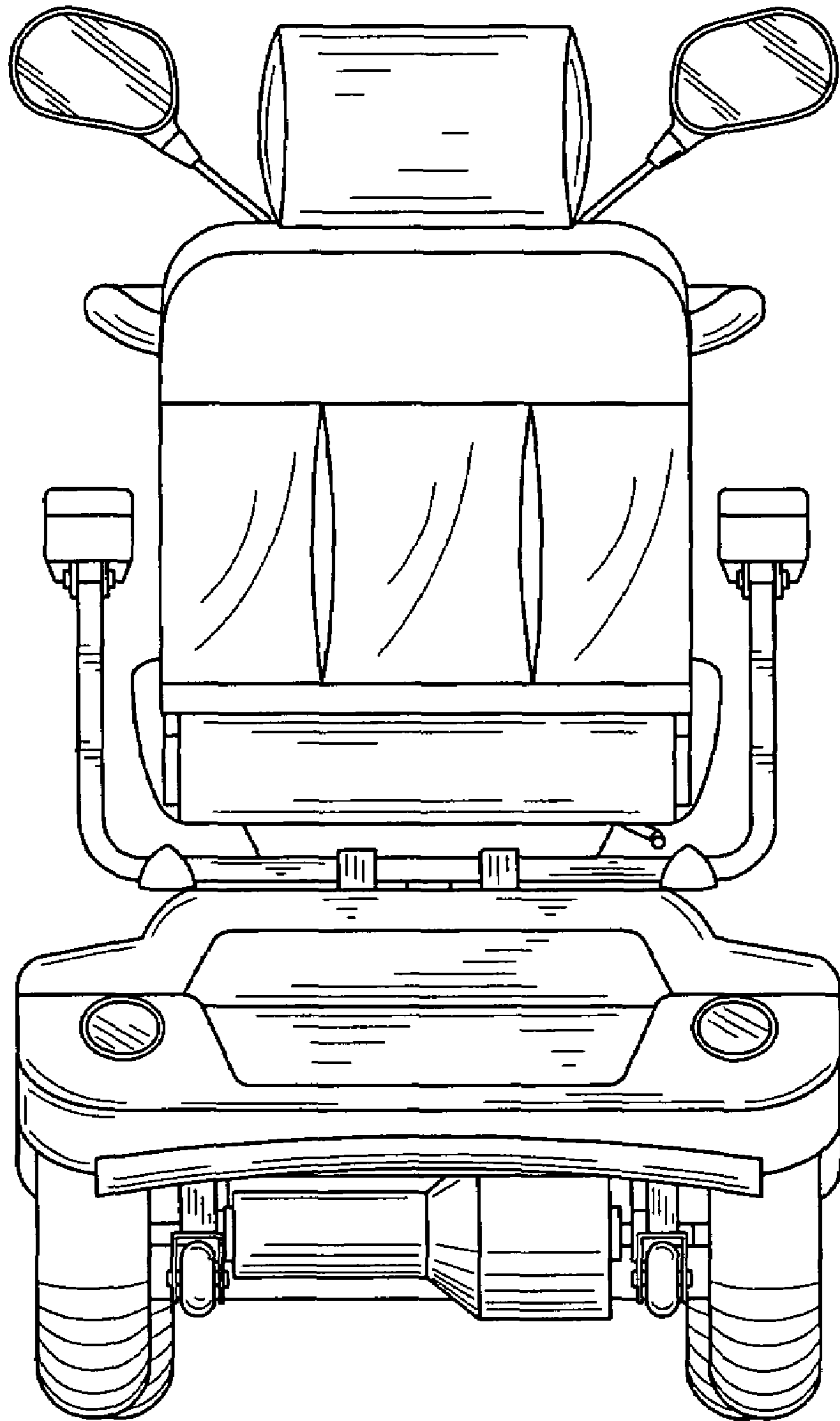

FIG. 3

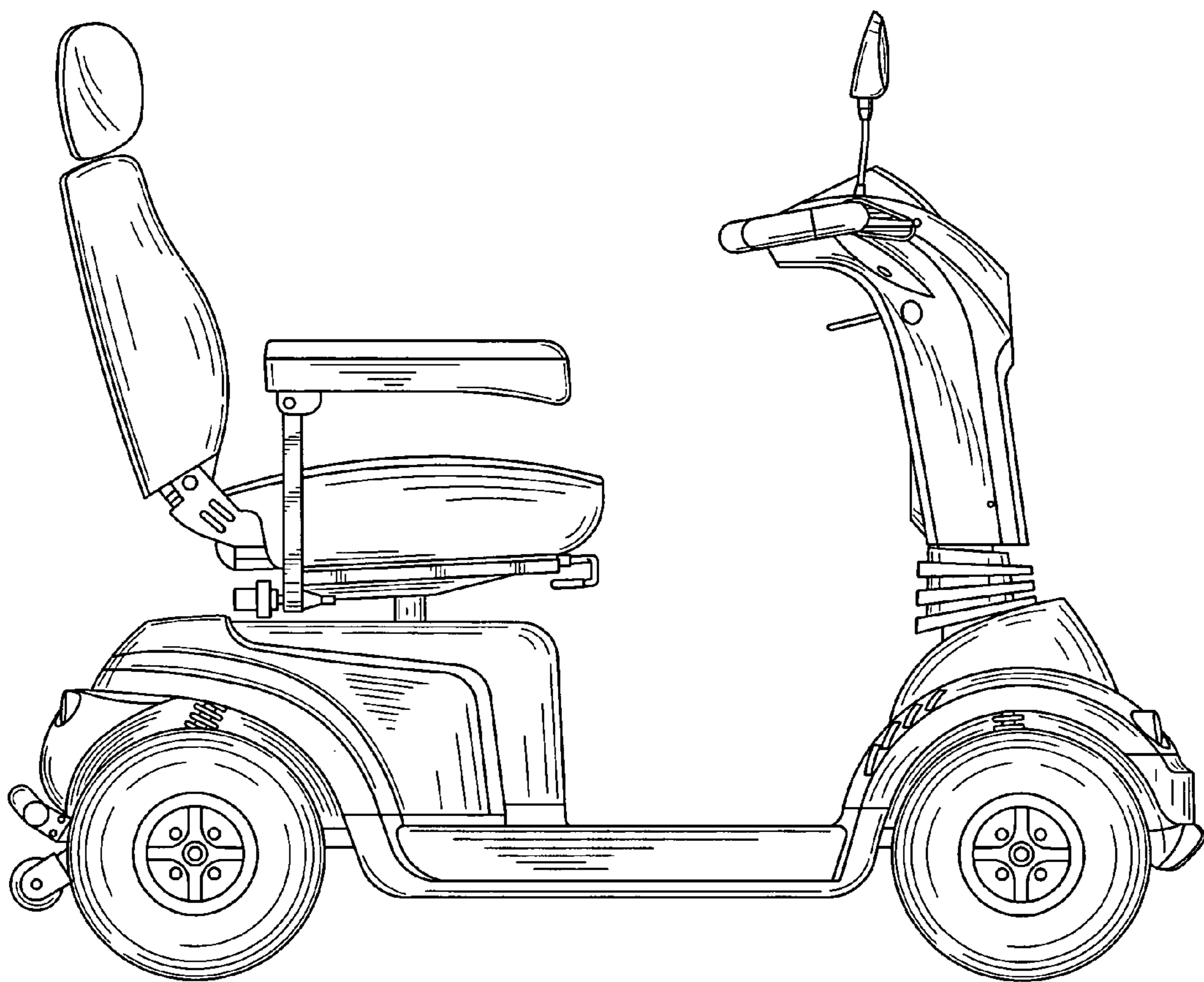

FIG. 4

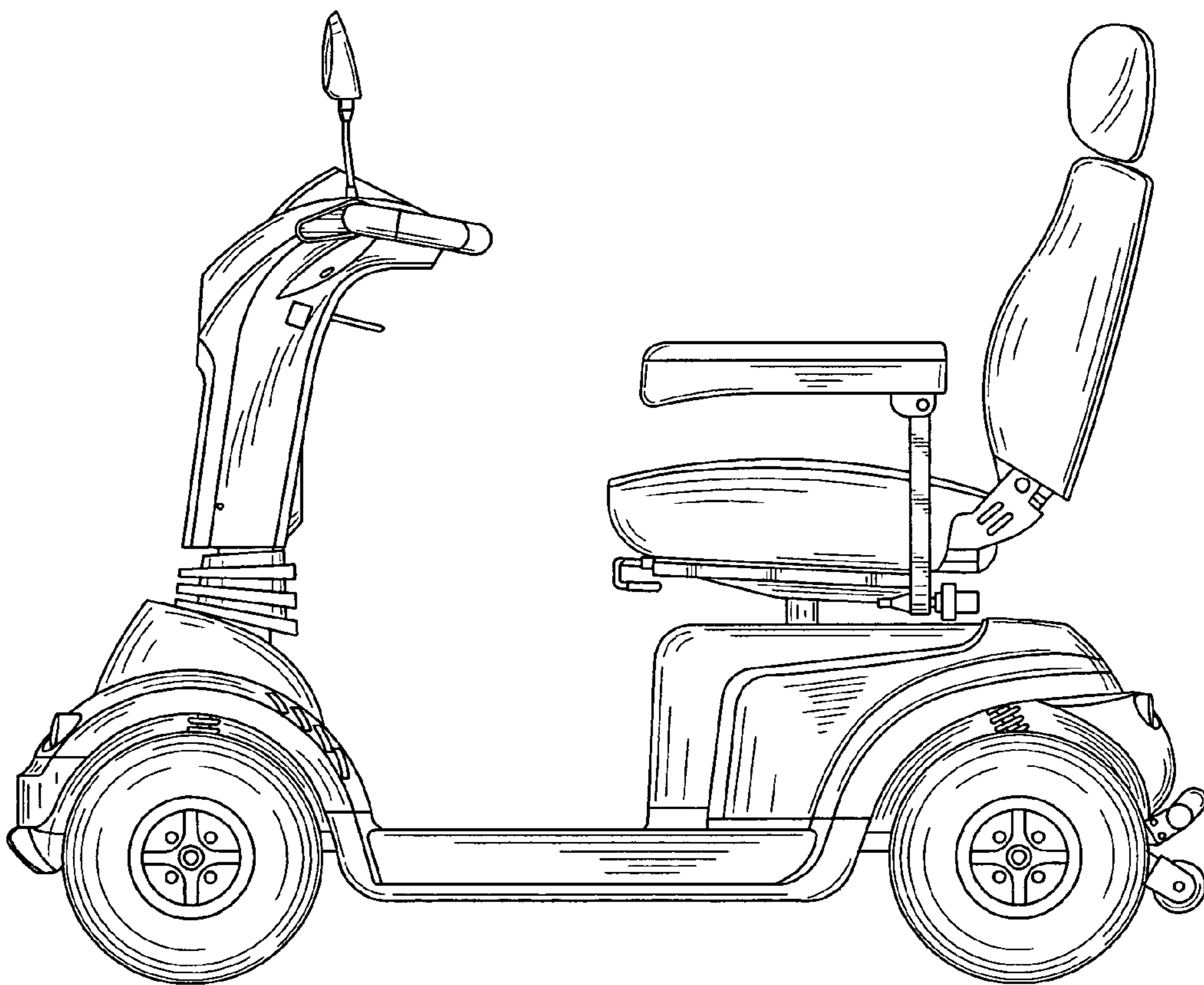

FIG. 5

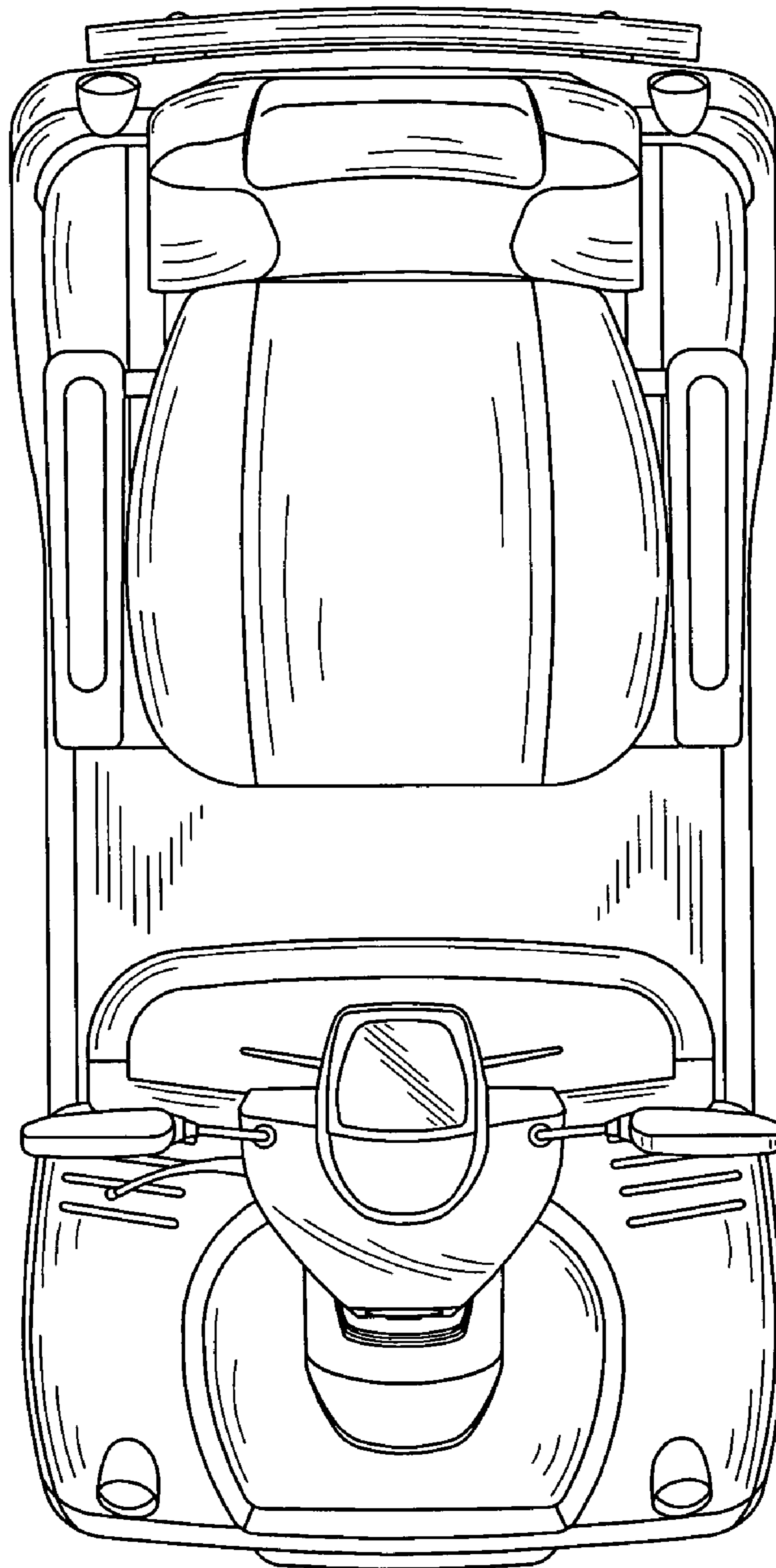

FIG. 6