



US00D576836S

(12) **United States Design Patent**
Jossem et al.

(10) **Patent No.:** **US D576,836 S**
(45) **Date of Patent:** **** Sep. 16, 2008**

(54) **FOOD PROCESSOR**

D555,305 S * 11/2007 Chun et al. D32/21
D556,398 S * 11/2007 Shin D32/21

(75) Inventors: **Adam A. Jossem**, Seattle, WA (US);
David A. Holcomb, Seattle, WA (US)

* cited by examiner

(73) Assignee: **Chef'n Corporation**, Seattle, WA (US)

Primary Examiner—Caron D. Veynar

Assistant Examiner—Ricky Pham

(**) Term: **14 Years**

(74) *Attorney, Agent, or Firm*—Seed IP Law Group PLLC

(21) Appl. No.: **29/282,965**

(57) **CLAIM**

(22) Filed: **Aug. 2, 2007**

The ornamental design for a food processor, as shown and described.

(51) **LOC (8) Cl.** **31-00**

(52) **U.S. Cl.** **D7/384**

(58) **Field of Classification Search** D7/376–386,
D7/402, 412–414, 665, 678, 693; D32/21;
99/492, 509–511; 241/166–169.1, 272–278.2,
241/285.1–285.3, 101.1, 291; 366/64–67,
366/98, 197–221, 241–254, 279–292, 341–343
See application file for complete search history.

DESCRIPTION

FIG. 1 is a perspective view of a food processor showing our new design.

FIG. 2 is a left side elevation view thereof.

FIG. 3 is a right side elevation view thereof.

FIG. 4 is a front elevation view thereof.

FIG. 5 is a rear elevation view thereof.

FIG. 6 is a top plan view thereof; and,

FIG. 7 is a bottom plan view thereof.

The broken lines in the figures are for illustrative purposes only and form no part of the claimed design.

(56) **References Cited**

U.S. PATENT DOCUMENTS

2,271,175 A * 1/1942 Mantelet 241/280
D399,617 S * 10/1998 Fujita D32/21
D477,754 S * 7/2003 Holcomb et al. D7/693
D537,305 S * 2/2007 Wan D7/678
7,264,189 B2 * 9/2007 Holcomb et al. 241/101.1

1 Claim, 6 Drawing Sheets

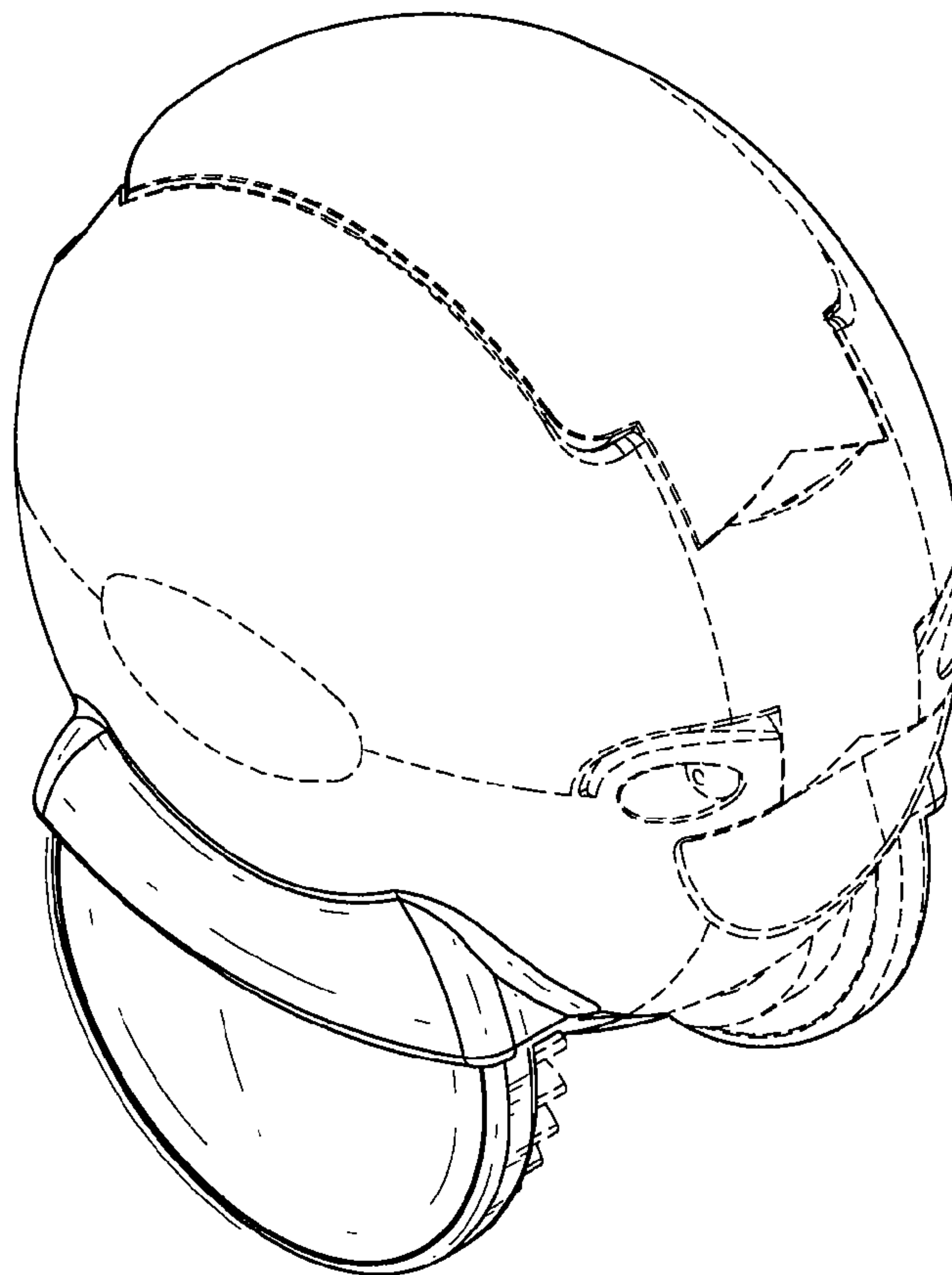

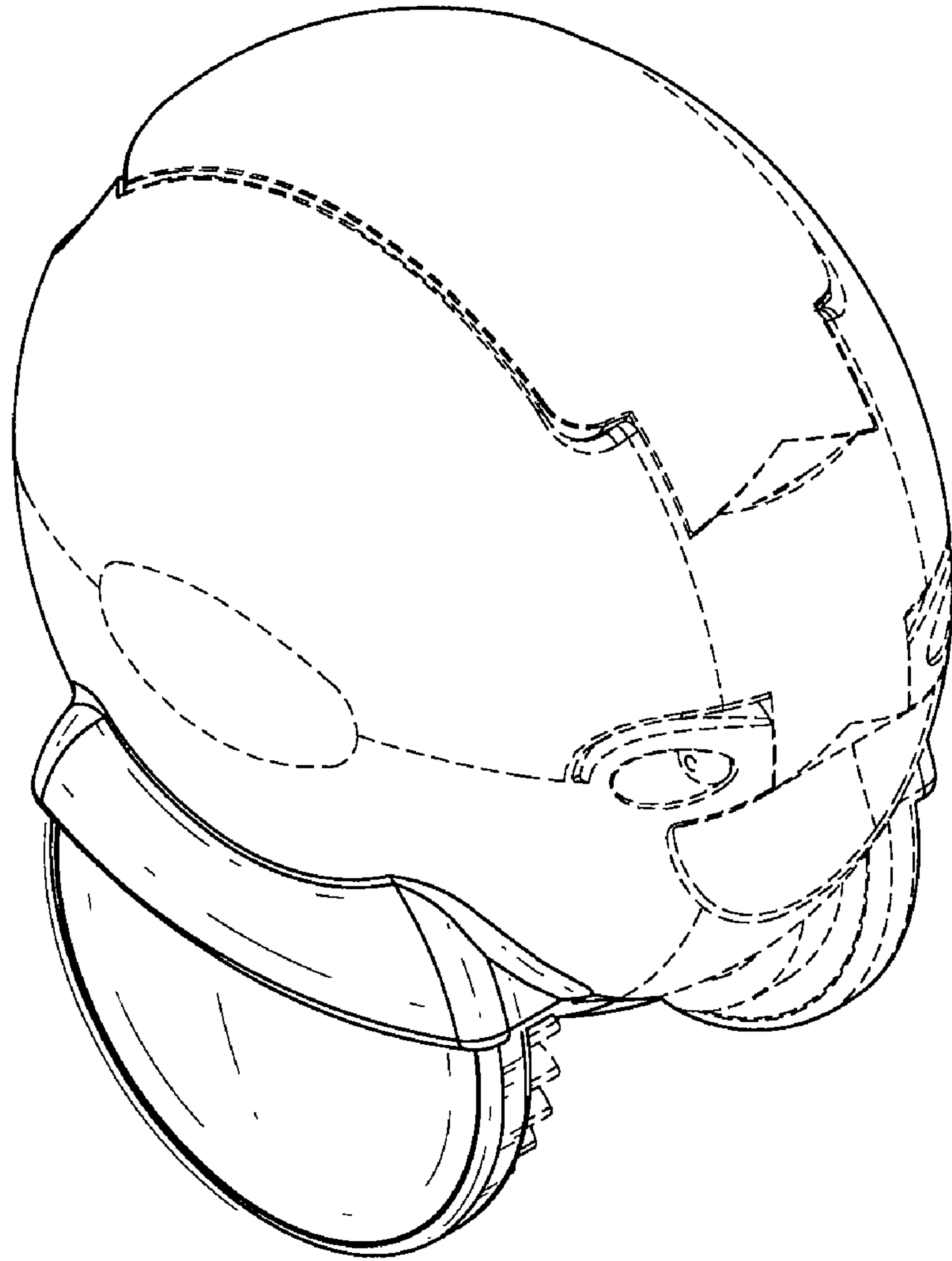

FIG. 1

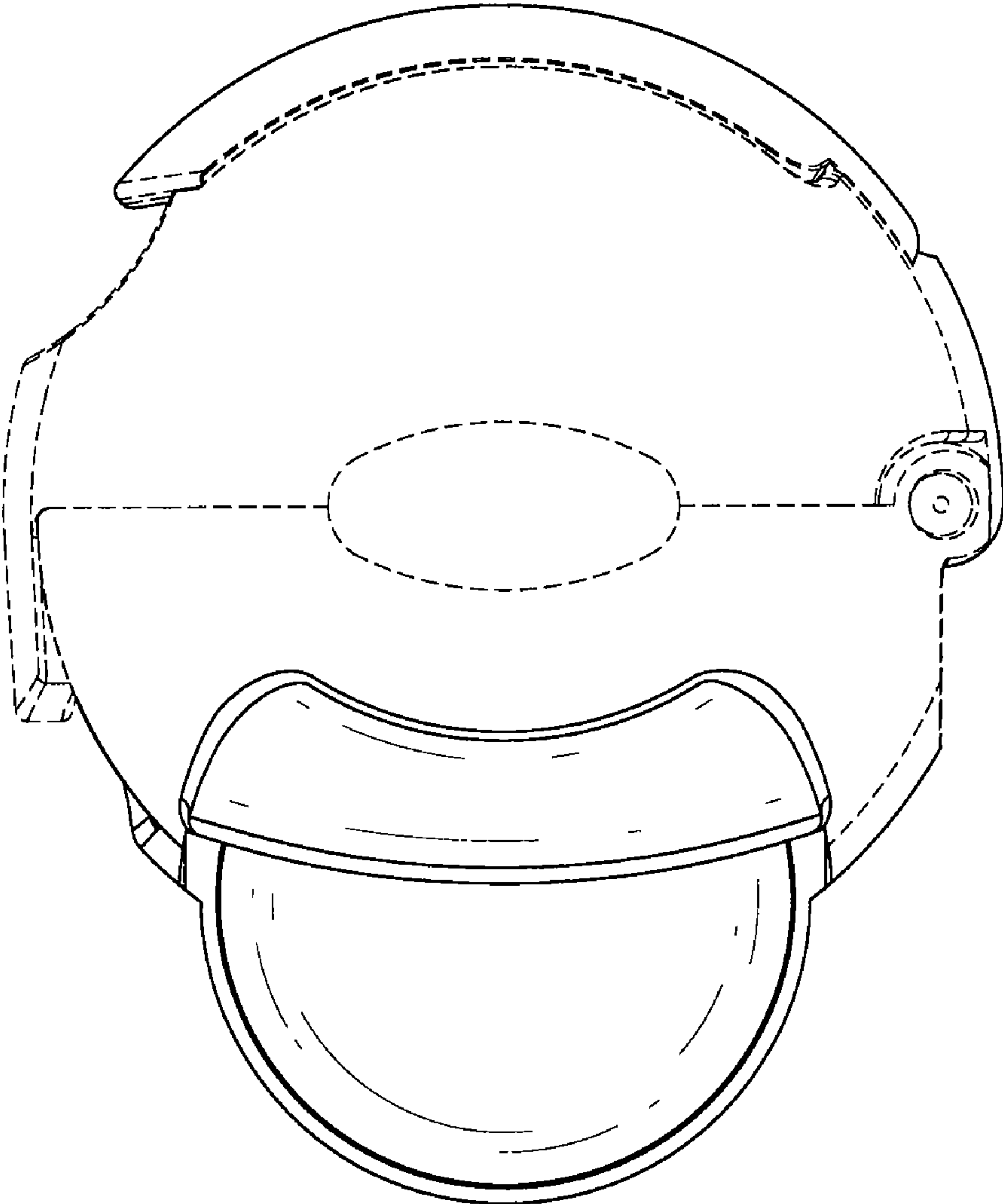

FIG. 2

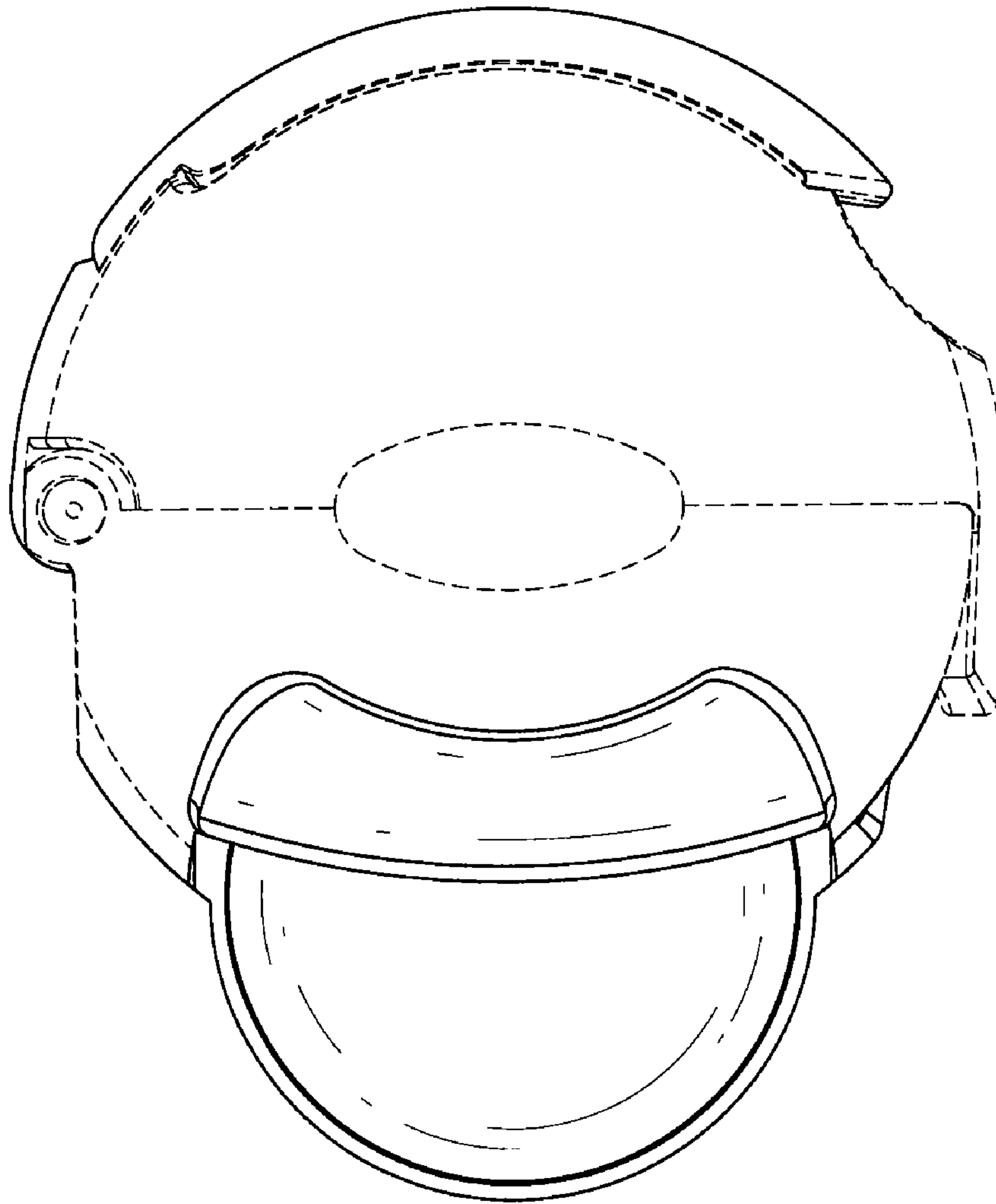

FIG. 3

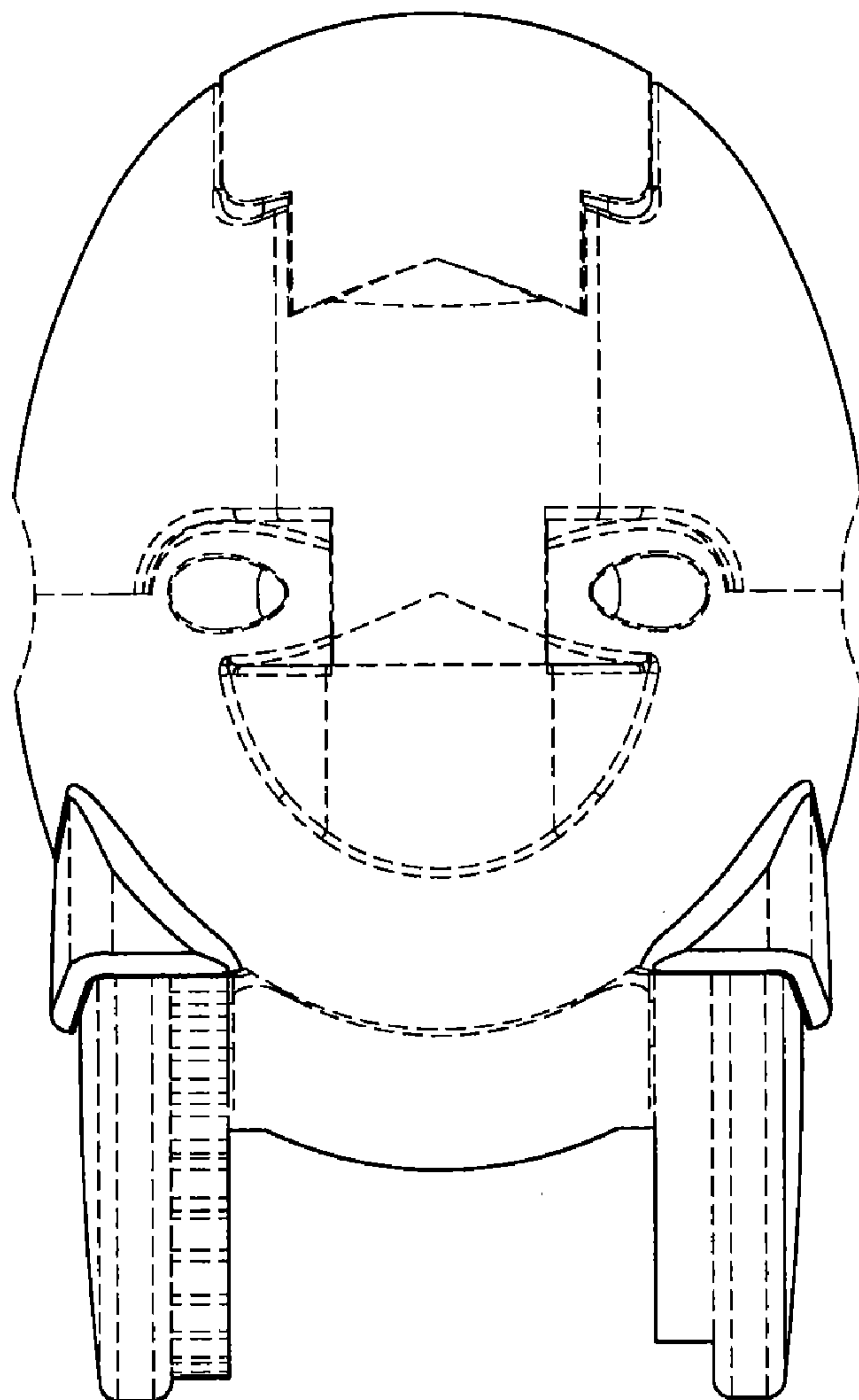

FIG. 4

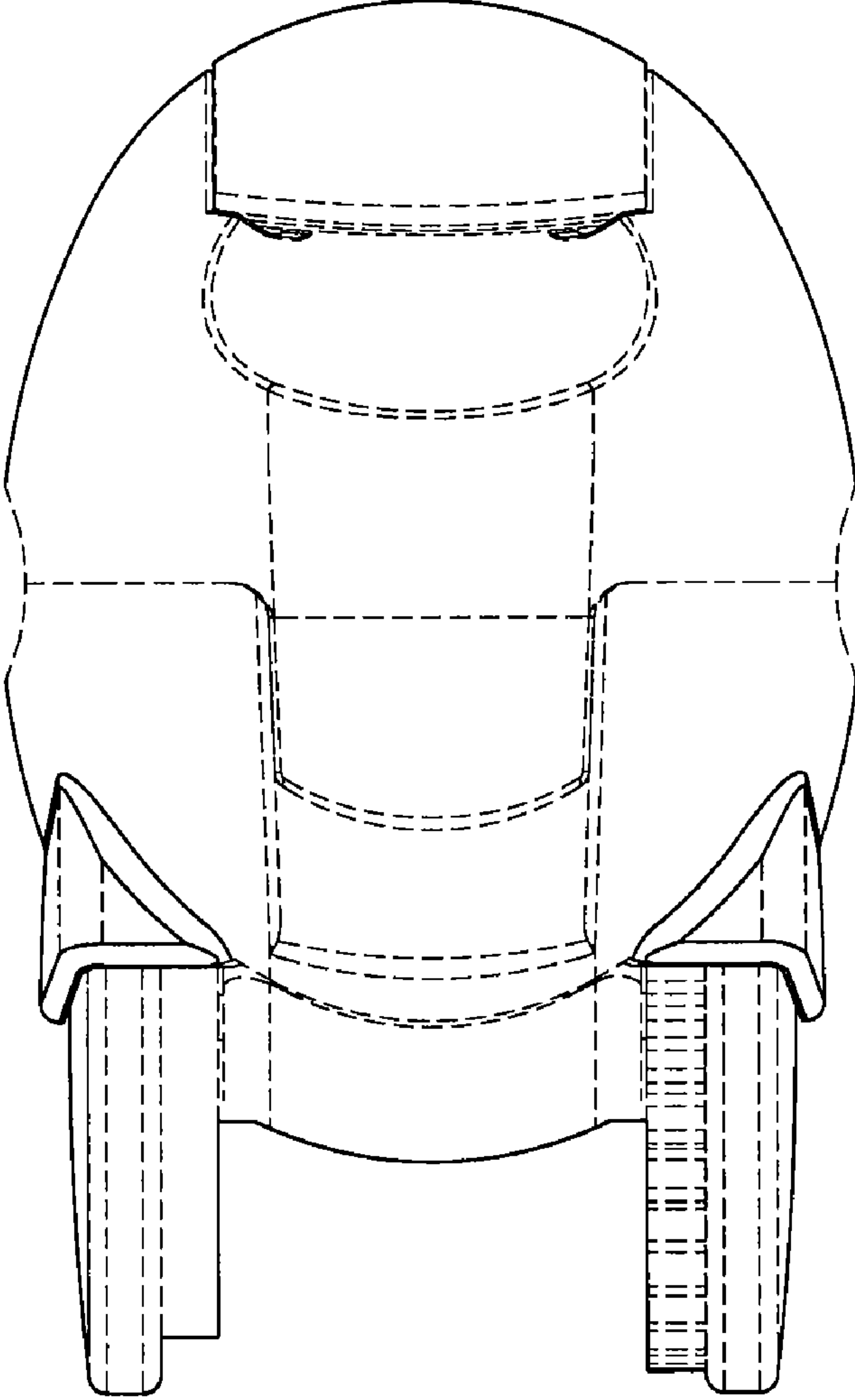

FIG. 5

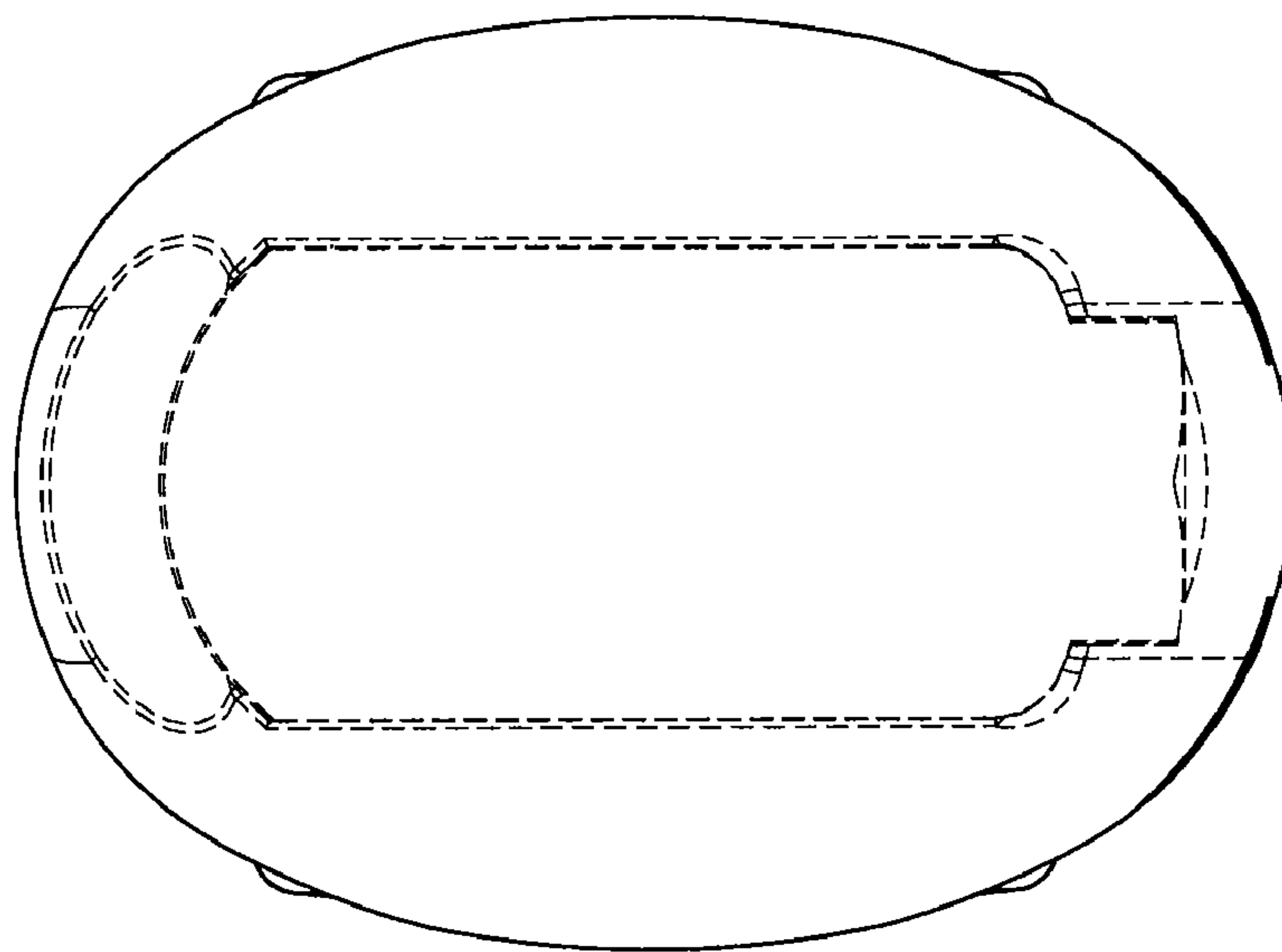

FIG. 6

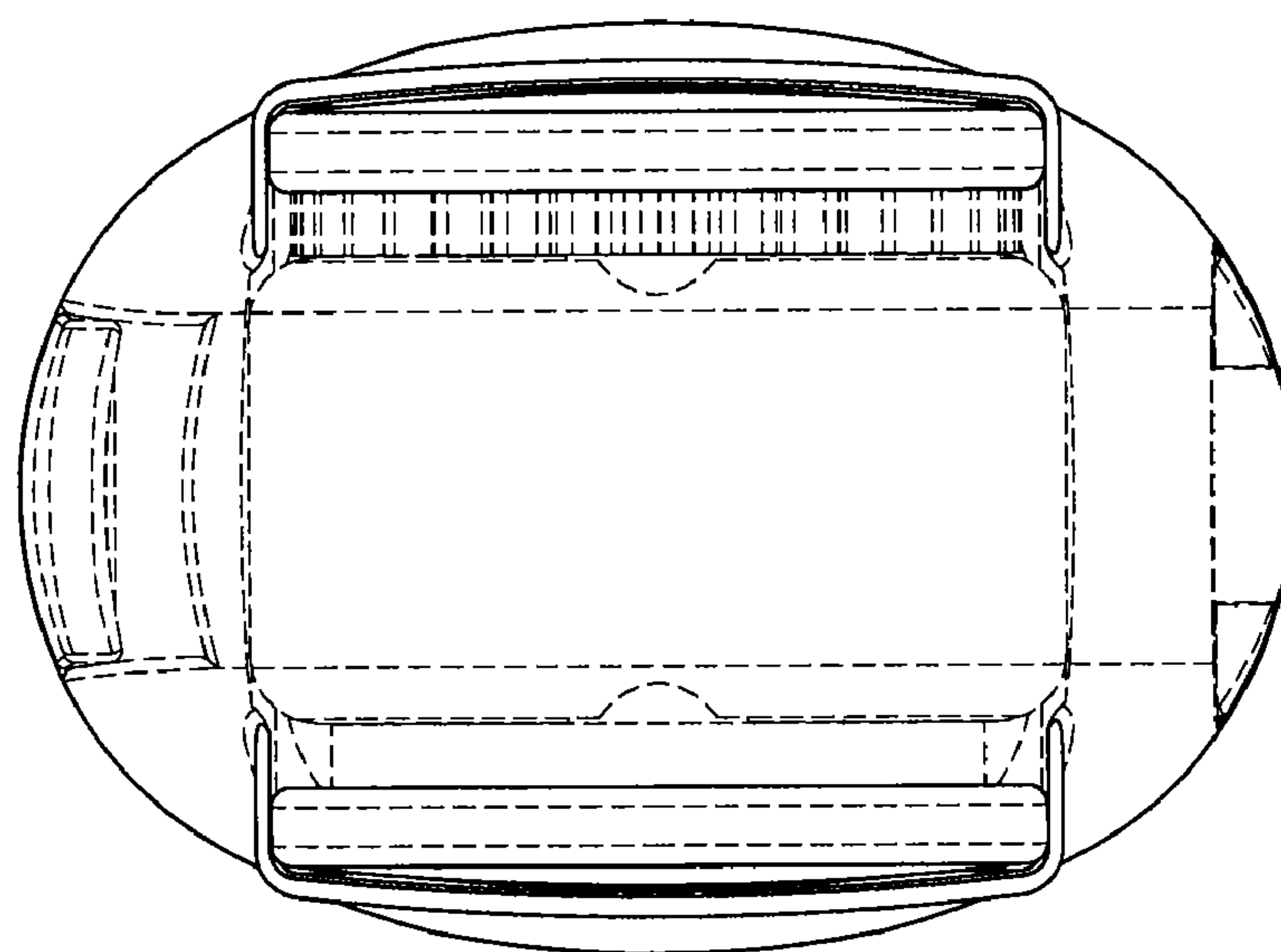

FIG. 7