



US00D576807S

(12) **United States Design Patent**  
**Le**

(10) **Patent No.:** **US D576,807 S**

(45) **Date of Patent:** **\*\* Sep. 16, 2008**

(54) **PEDICURE SPA**

(76) **Inventor:** **Vinh Chi Le**, 9004 Westbay Blvd.,  
Tampa, FL (US) 33615

(\*\*) **Term:** **14 Years**

(21) **Appl. No.:** **29/301,518**

(22) **Filed:** **Mar. 5, 2008**

(51) **LOC (8) Cl.** ..... **06-01**

(52) **U.S. Cl.** ..... **D6/336**

(58) **Field of Classification Search** ..... D6/335-338,  
D6/360-361, 367, 491, 495, 500-502; 297/188.01,  
297/423.19, 135, 180.15; D28/56, 61; 4/622;  
601/158

See application file for complete search history.

(56) **References Cited**

**U.S. PATENT DOCUMENTS**

D424,819	S	*	5/2000	Galati et al.	.....	D6/336
D434,916	S	*	12/2000	Galati et al.	.....	D6/336
D454,705	S	*	3/2002	Long et al.	.....	D6/336
D455,017	S	*	4/2002	Tran	.....	D6/336
D455,566	S	*	4/2002	Park	.....	D6/336
D456,154	S	*	4/2002	Huynh et al.	.....	D6/336
6,503,212	B2	*	1/2003	Park	.....	601/158
D498,599	S	*	11/2004	Luong	.....	D6/336
D504,783	S	*	5/2005	Park	.....	D6/336

D505,021	S	*	5/2005	Kim	.....	D6/336
D520,761	S	*	5/2006	Masuda	.....	D6/336
D562,575	S	*	2/2008	Le	.....	D6/336
2004/0060108	A1	*	4/2004	Hoon Park	.....	4/622
2004/0261173	A1	*	12/2004	Chen	.....	4/622
2006/0242760	A1	*	11/2006	Chao	.....	4/622
2007/0226896	A1	*	10/2007	Fugate et al.	.....	4/622

\* cited by examiner

*Primary Examiner*—Sandra Snapp

(74) *Attorney, Agent, or Firm*—Pennington, Moore, Wilkinson, Bell & Dunbar, P.A.; Sidney W. Kilgore

(57) **CLAIM**

The ornamental design for a pedicure spa, as shown and described.

**DESCRIPTION**

FIG. 1 is a front view of a 'pedicure spa' showing the new design of the Applicant;

FIG. 2 is a rear view of thereof;

FIG. 3 is a right side view thereof;

FIG. 4 is a left side view thereof;

FIG. 5 is an overhead view thereof;

FIG. 6 is an underside view thereof; and,

FIG. 7 is a perspective view thereof.

**1 Claim, 6 Drawing Sheets**

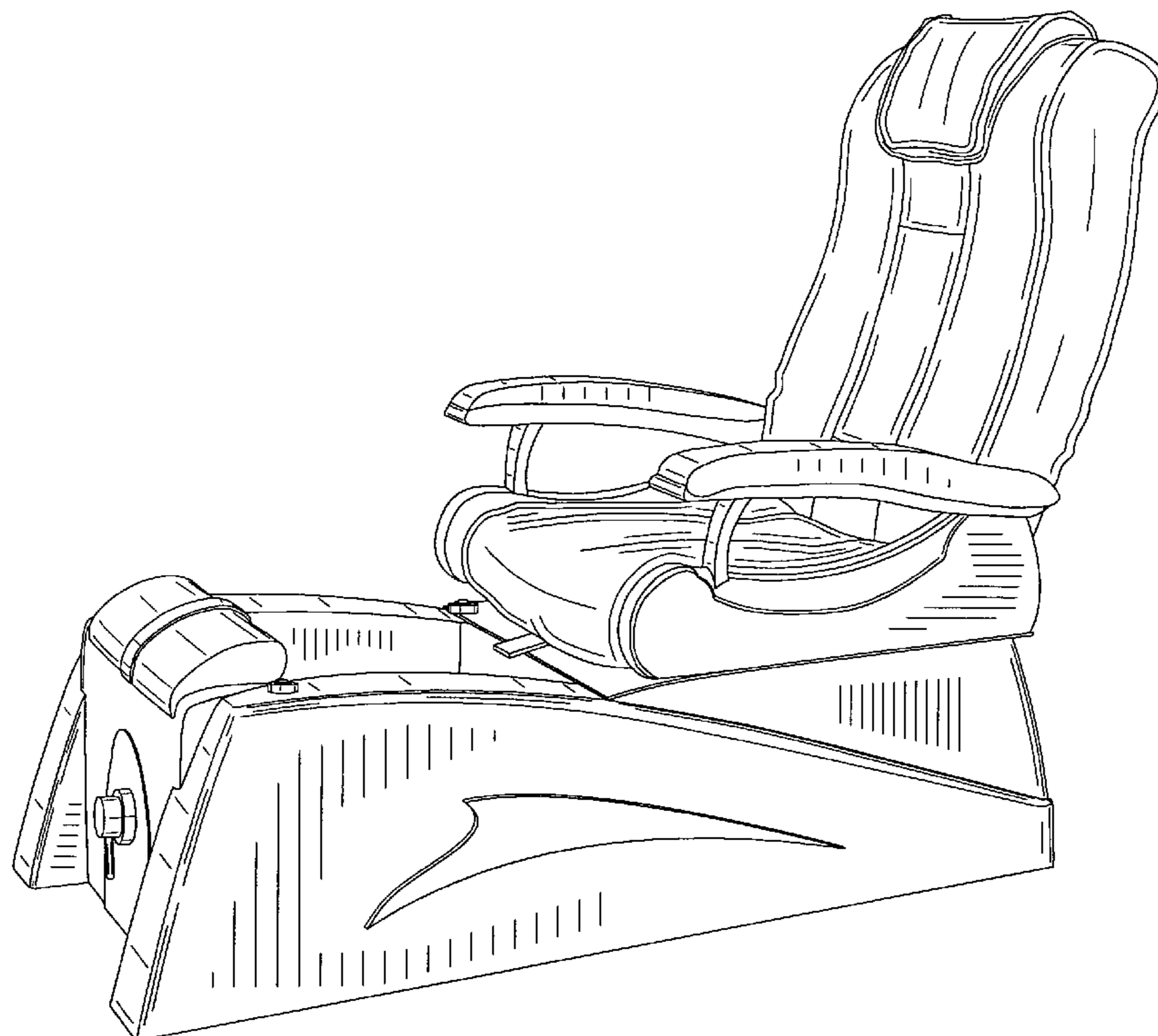

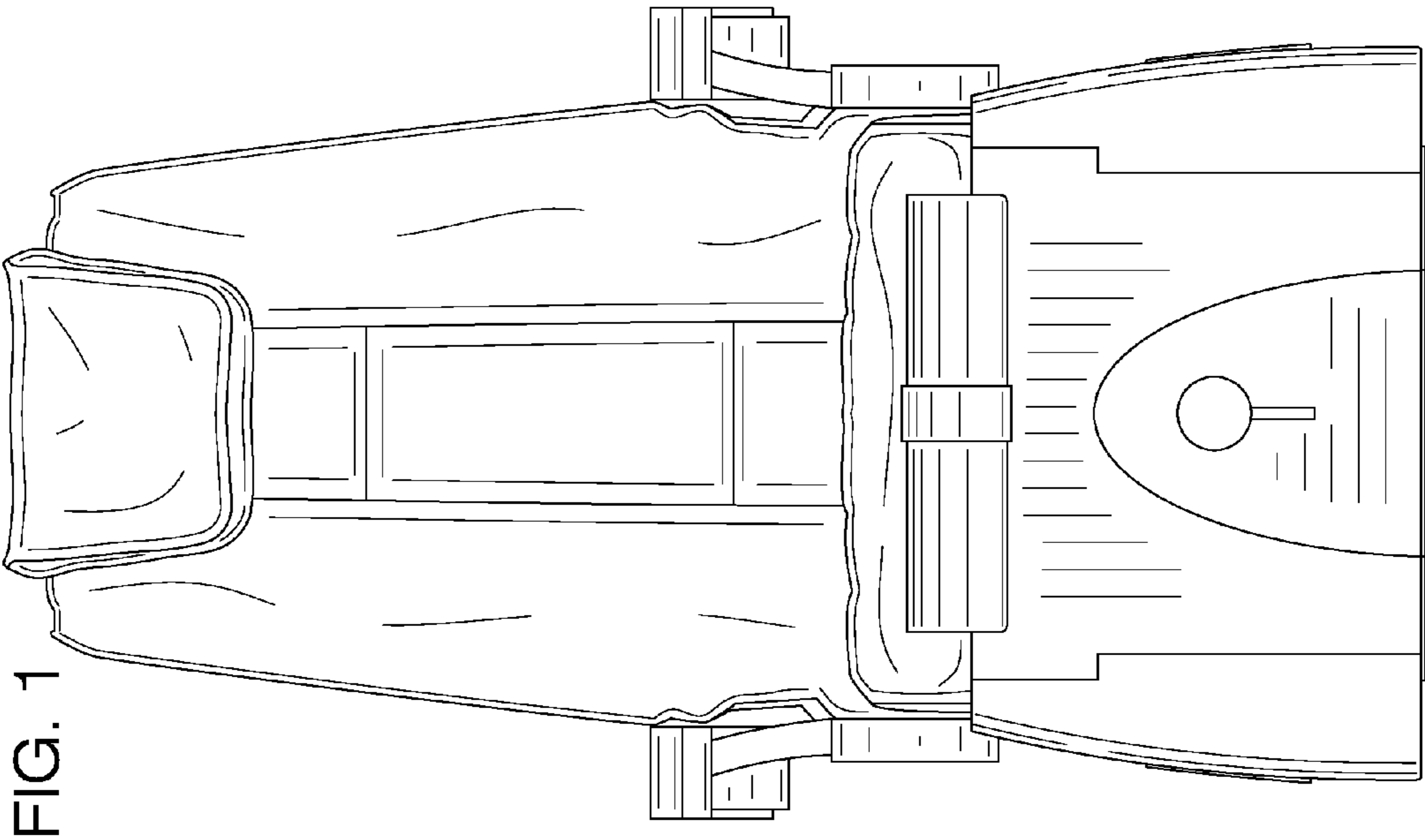
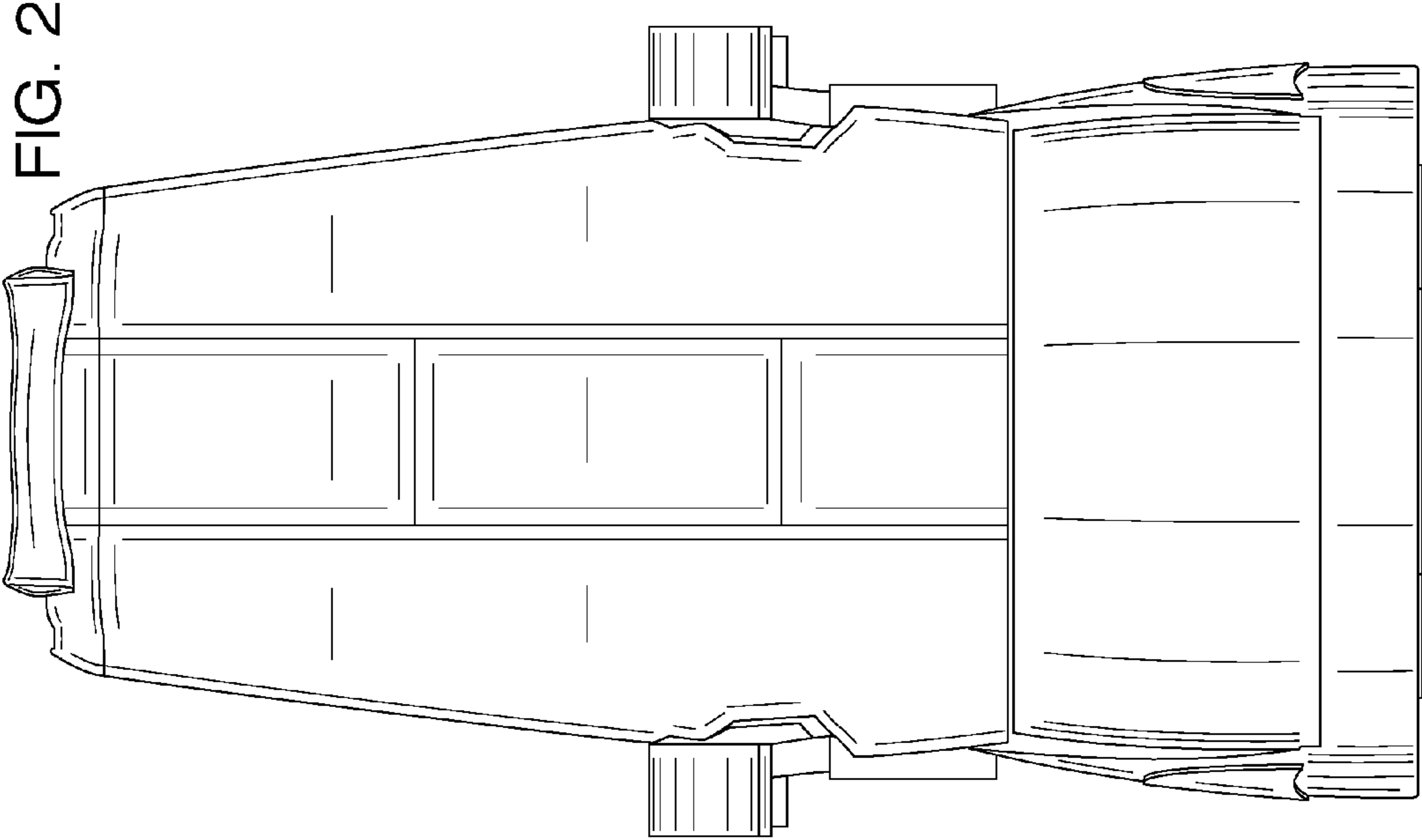

FIG. 2

FIG. 1

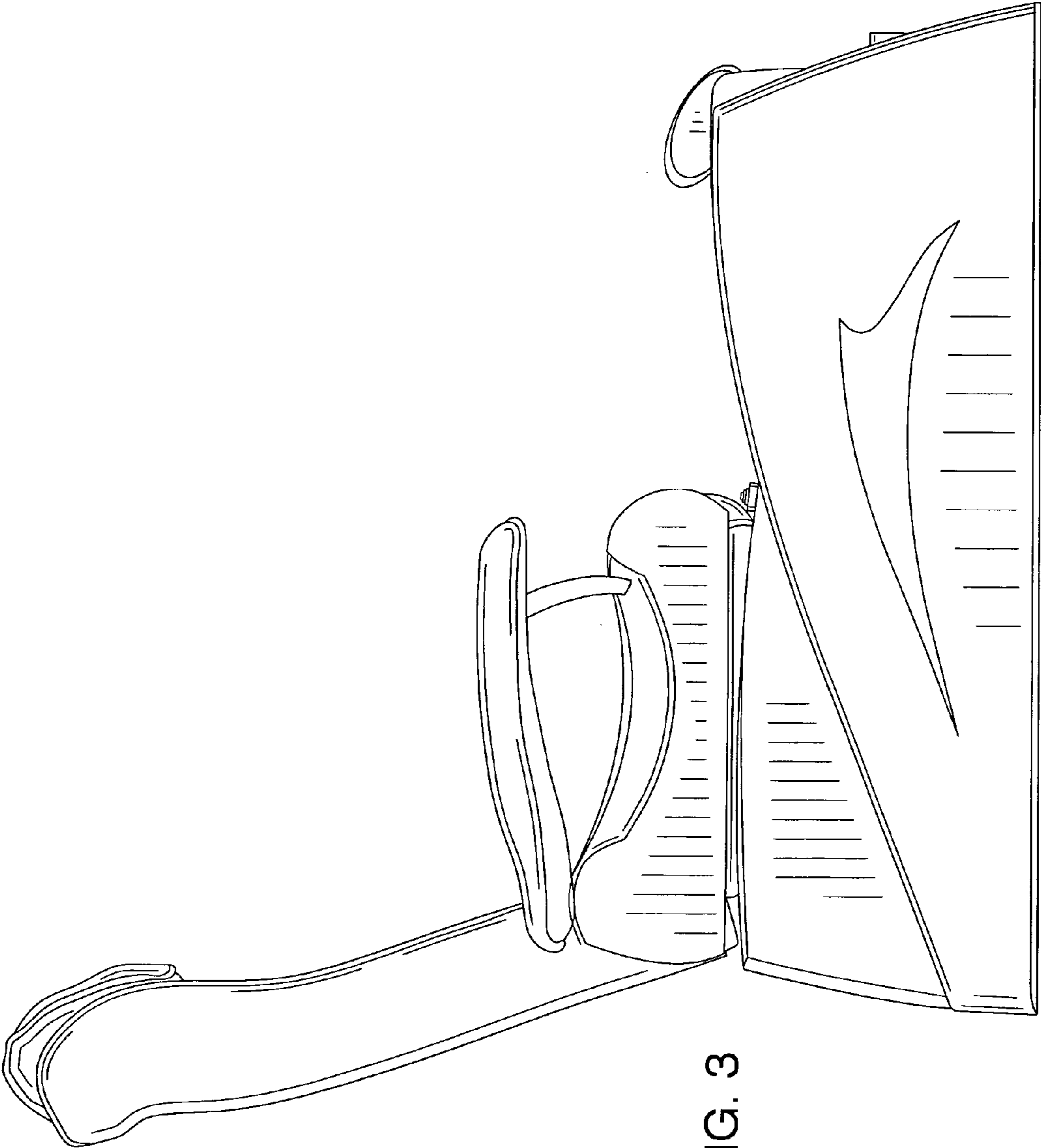

FIG. 3

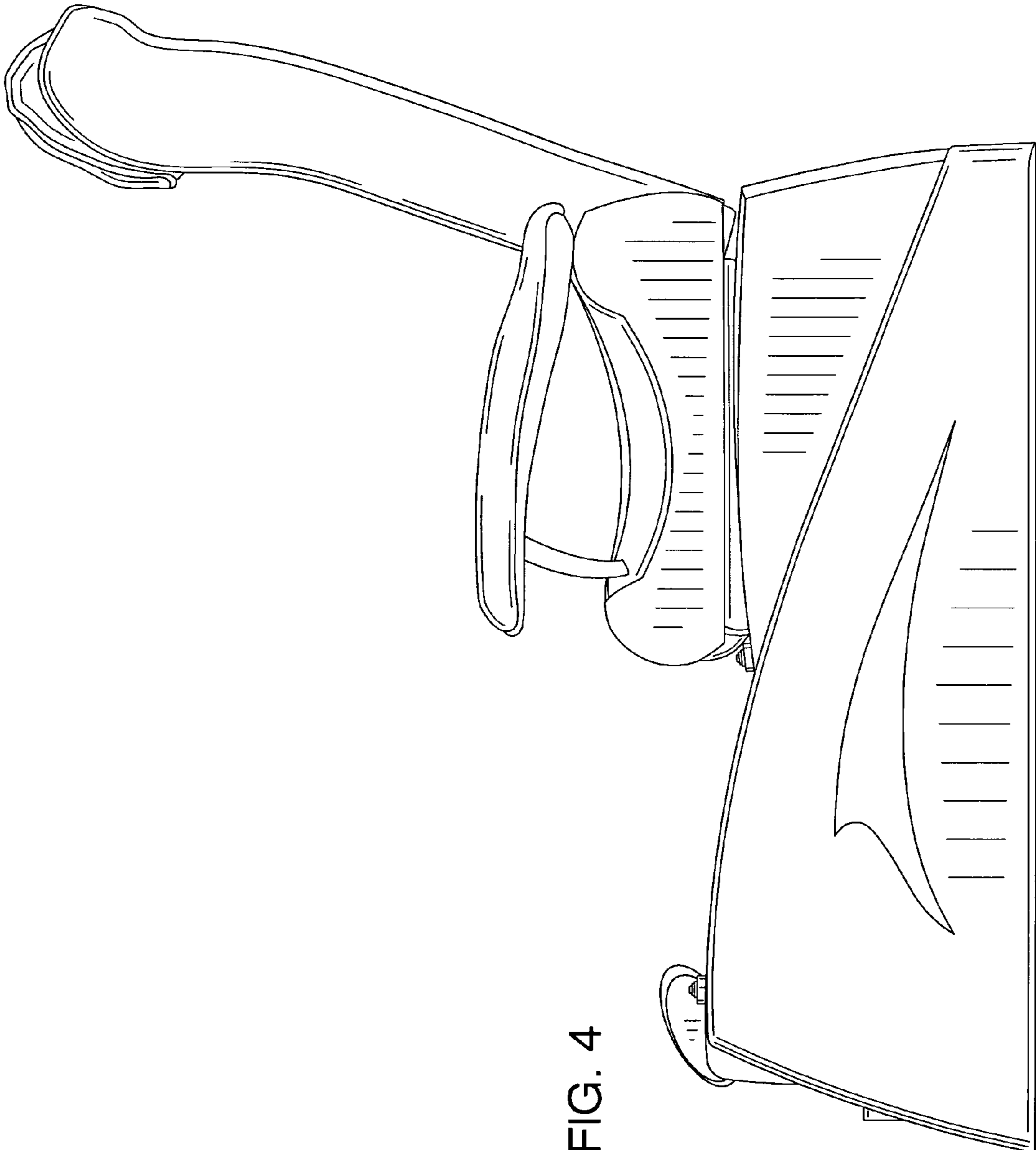
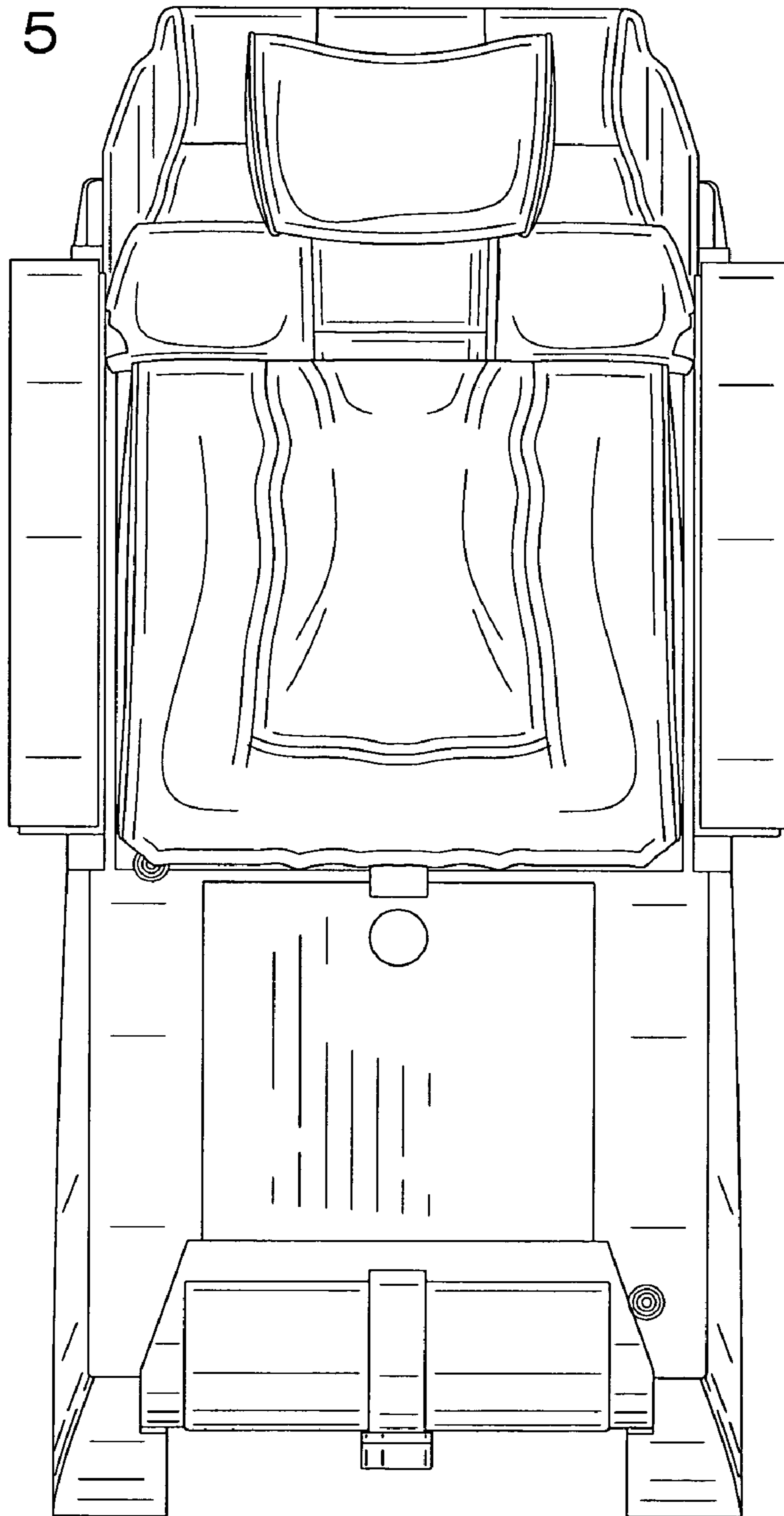

FIG. 4

FIG. 5



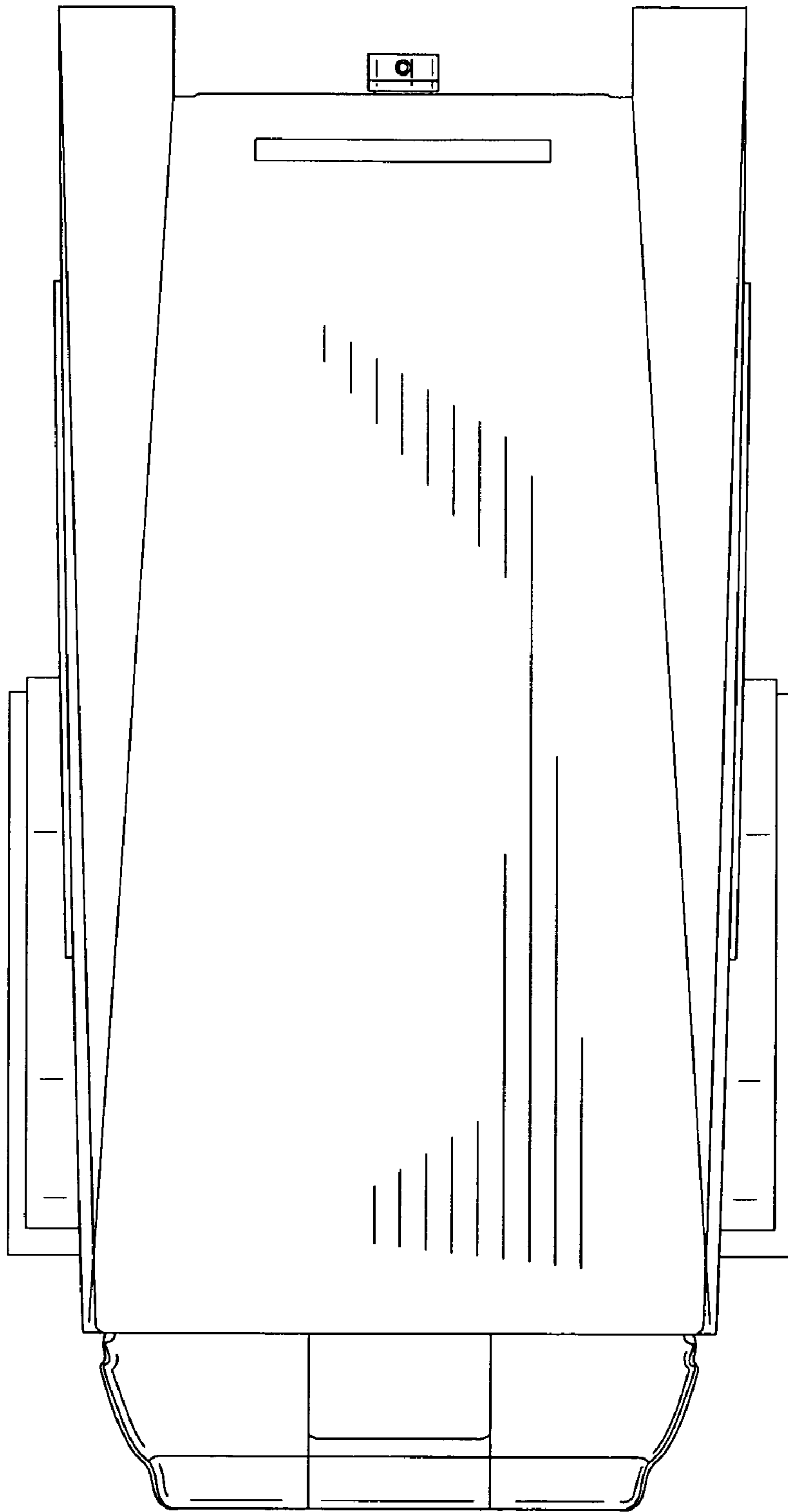

FIG. 6

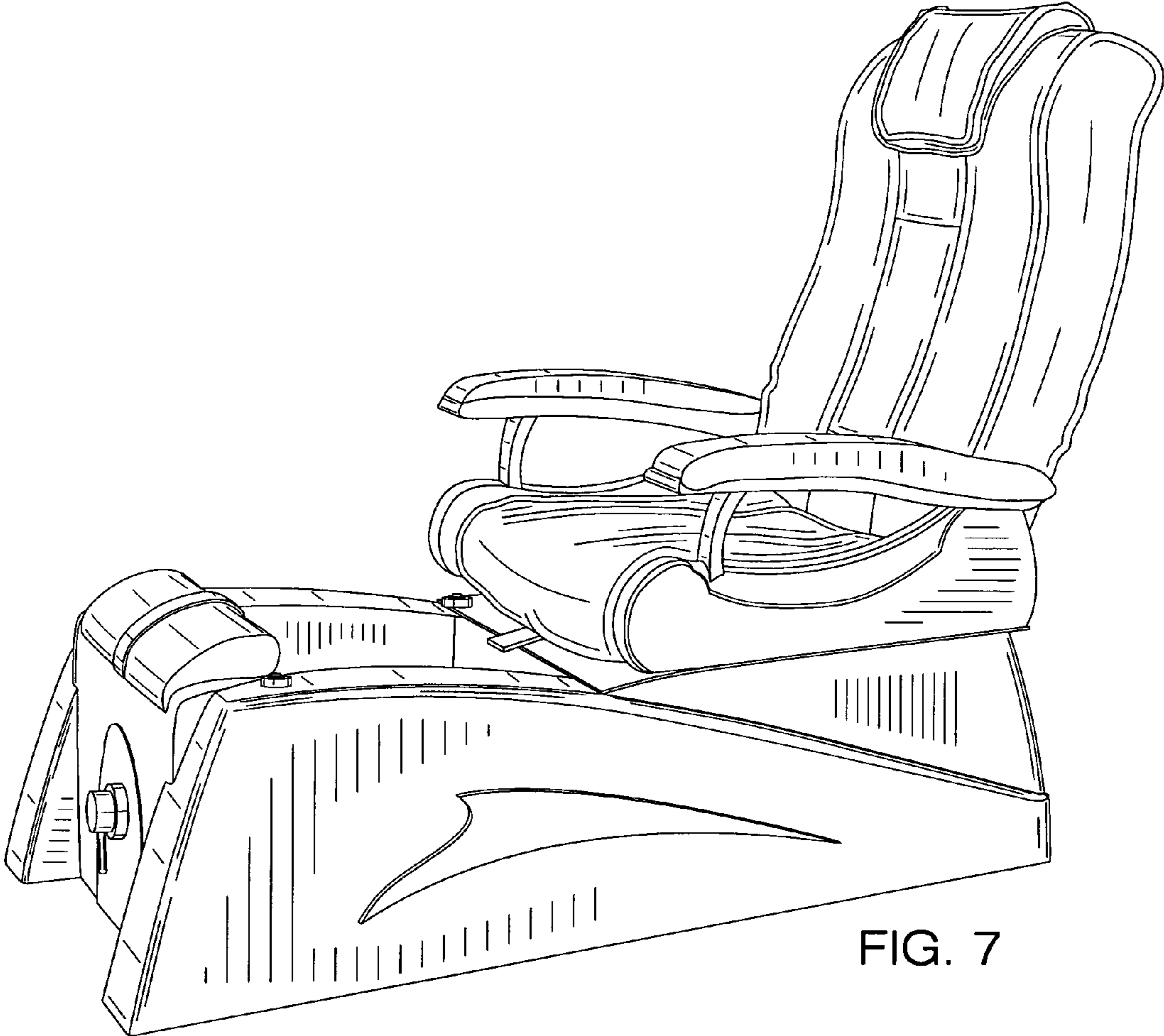

FIG. 7