



US00D576738S

(12) **United States Design Patent**  
**Sullivan**

(10) **Patent No.:** **US D576,738 S**  
(45) **Date of Patent:** **\*\* Sep. 9, 2008**

- (54) **FIBERGLASS SWIMMING POOL**
- (75) Inventor: **Todd Sullivan**, Eloy, AZ (US)
- (73) Assignee: **San Juan Patents, Inc.**, Lakeland, FL (US)
- (\*\*) Term: **14 Years**
- (21) Appl. No.: **29/288,561**
- (22) Filed: **Jun. 15, 2007**
- (51) **LOC (8) Cl.** ..... **25-03**
- (52) **U.S. Cl.** ..... **D25/2**
- (58) **Field of Classification Search** ..... D25/2, D25/8; 4/488, 506; D24/204  
See application file for complete search history.

D509,902 S	9/2005	Sullivan	
D509,903 S	9/2005	Sullivan	
D510,630 S	10/2005	Sullivan	
D513,802 S *	1/2006	Loyd .....	D24/204
D514,228 S	1/2006	Sullivan	
D514,229 S	1/2006	Sullivan	
D514,708 S	2/2006	Sullivan	
D542,417 S *	5/2007	Larsen .....	D24/204
D543,282 S *	5/2007	Larsen .....	D24/204
D546,474 S	7/2007	Sullivan	

(56) **References Cited**  
U.S. PATENT DOCUMENTS

D179,930 S	3/1957	Culver
3,428,969 A	2/1969	Diemond et al.
3,511,002 A	5/1970	Fox
3,530,512 A	9/1970	McBride
D251,201 S	2/1979	Mathis
D275,608 S	9/1984	Sullivan
D275,609 S	9/1984	Monten
D277,135 S	1/1985	Sullivan
D278,932 S	5/1985	Sullivan
D278,933 S	5/1985	Sullivan
4,566,141 A	1/1986	Mahoney
D285,350 S	8/1986	Sullivan
D347,697 S	6/1994	Weir
D408,547 S	4/1999	Sullivan
D408,548 S	4/1999	Sullivan
D408,549 S	4/1999	Sullivan
D408,550 S	4/1999	Sullivan
D408,551 S	4/1999	Sullivan
D408,927 S	4/1999	Sullivan
D408,928 S	4/1999	Sullivan
D417,286 S	11/1999	Sullivan
D430,305 S	8/2000	Sullivan
D446,313 S	8/2001	Sullivan
D460,194 S	7/2002	Sullivan
D460,195 S	7/2002	Sullivan
D471,282 S	3/2003	Sullivan
D471,283 S	3/2003	Sullivan
D509,593 S	9/2005	Sullivan

**OTHER PUBLICATIONS**

<http://www.sanjuanpools.com/pools/725Web.jpg> Mar. 18, 2008.\*  
Oasis: The Magazine of San Juan Pools, published by San Juan Products, 2002.

\* cited by examiner

*Primary Examiner*—Louis S Zarfaz  
*Assistant Examiner*—Kathleen M Sims  
(74) *Attorney, Agent, or Firm*—Stetina Brunda Garred & Brucker

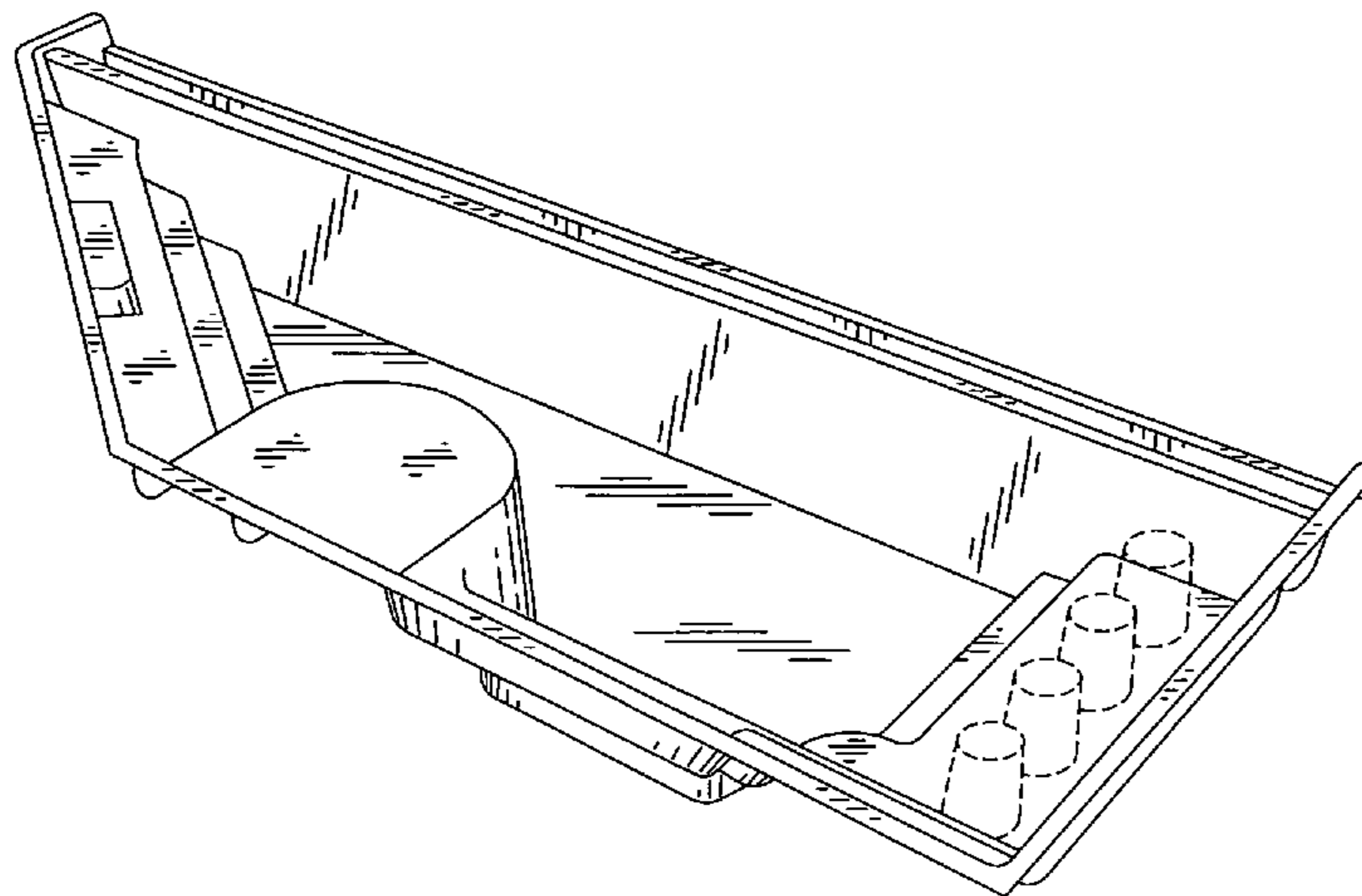
(57) **CLAIM**

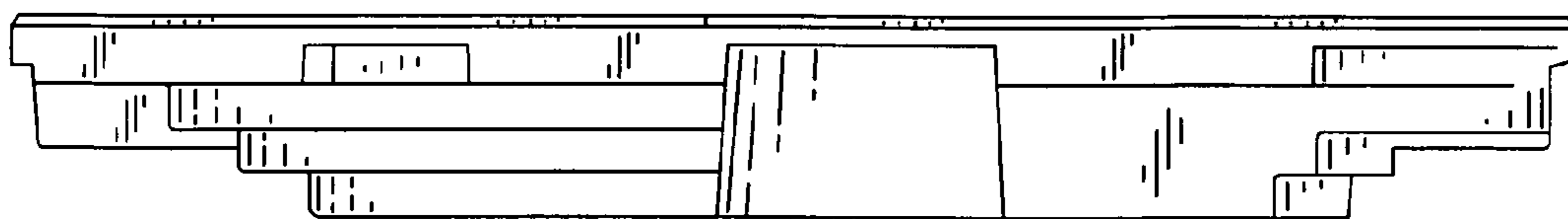
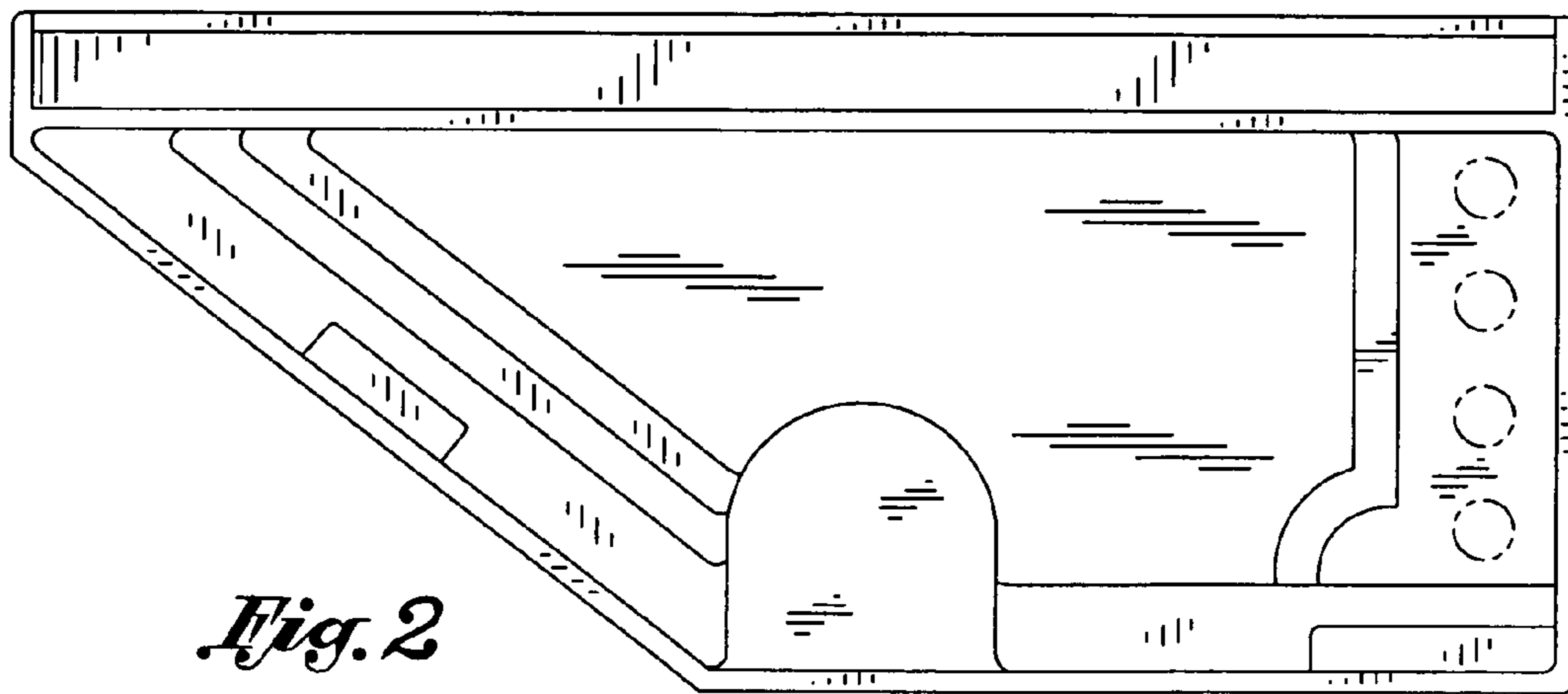
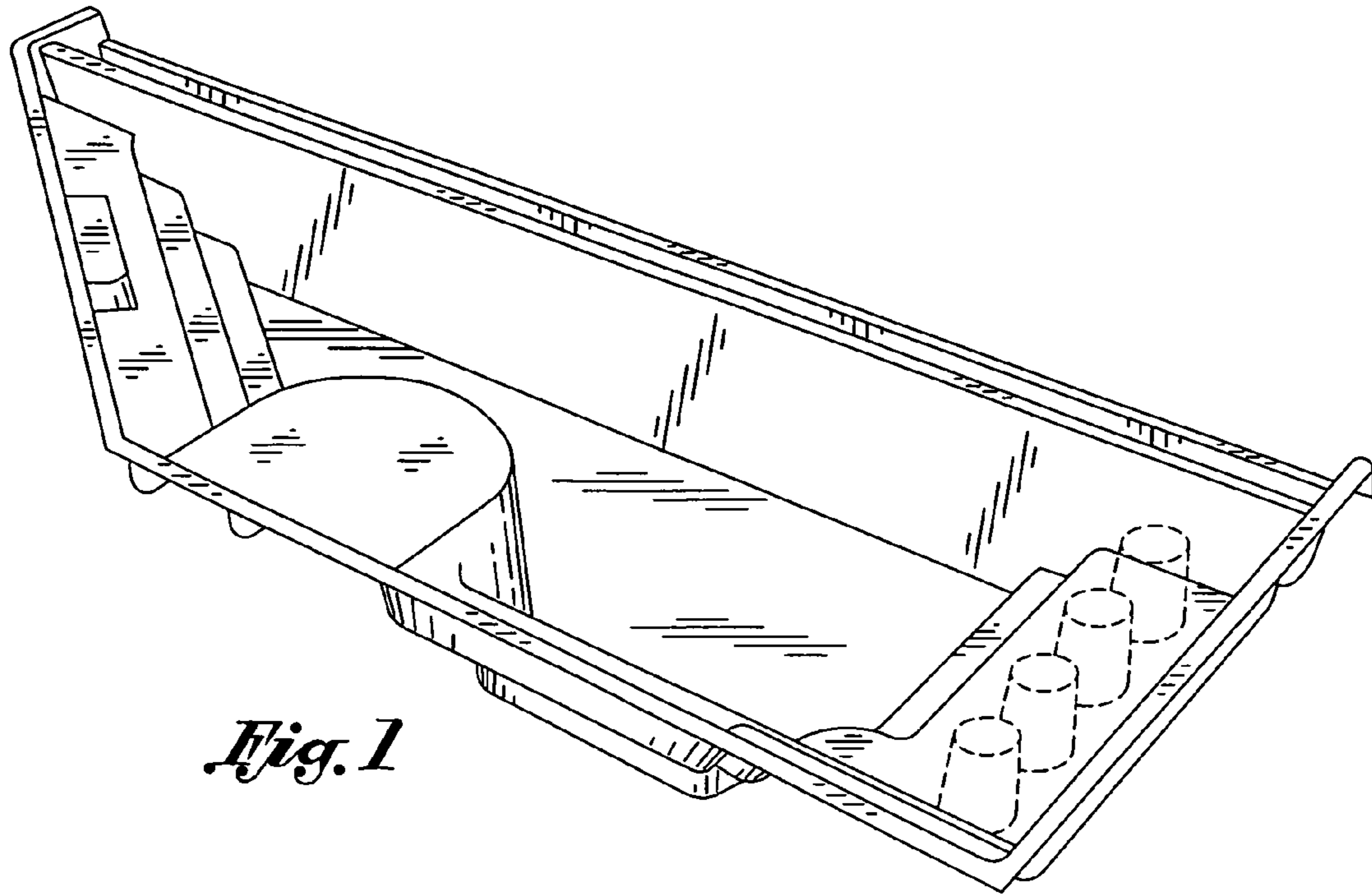
The ornamental design for a fiberglass swimming pool, as shown and described.

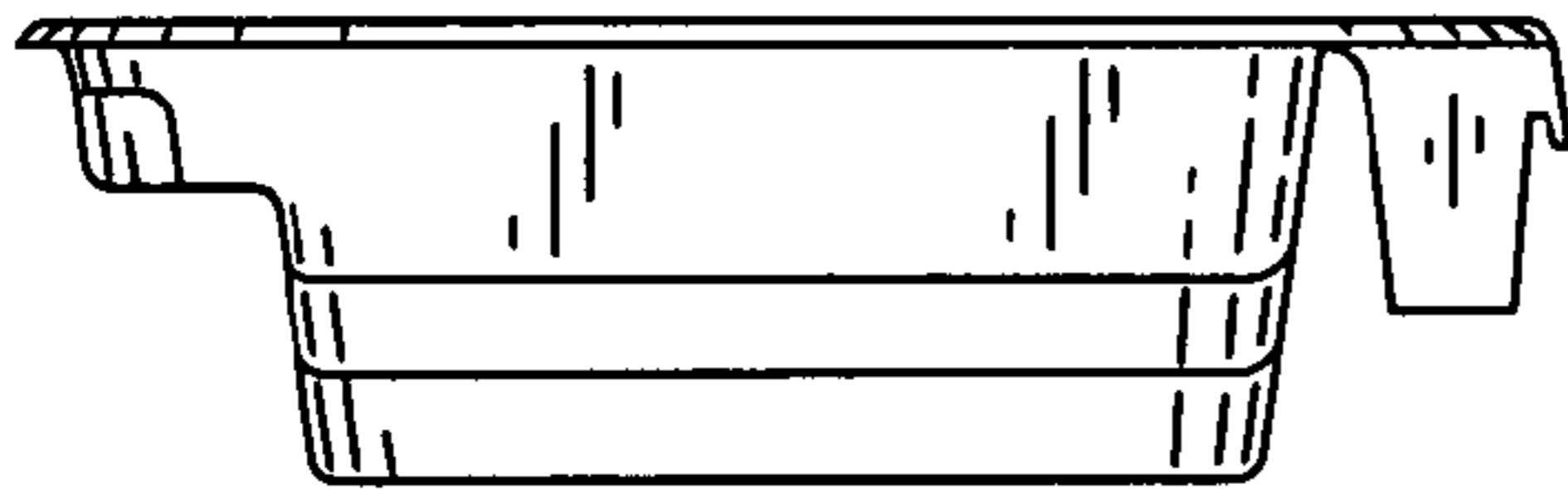
**DESCRIPTION**

FIG. 1 is a front perspective view of a fiberglass swimming pool showing my new design;  
FIG. 2 is a top view thereof;  
FIG. 3 is a left side view thereof;  
FIG. 4 is a rear view thereof;  
FIG. 5 is a frontal view thereof;  
FIG. 6 is right side view thereof; and,  
FIG. 7 is a bottom view thereof.  
The broken line showing of circular elements in FIGS. 1 and 2 is included for the purpose of illustrating portions of the fiberglass swimming pool and forms no part of the claimed design.

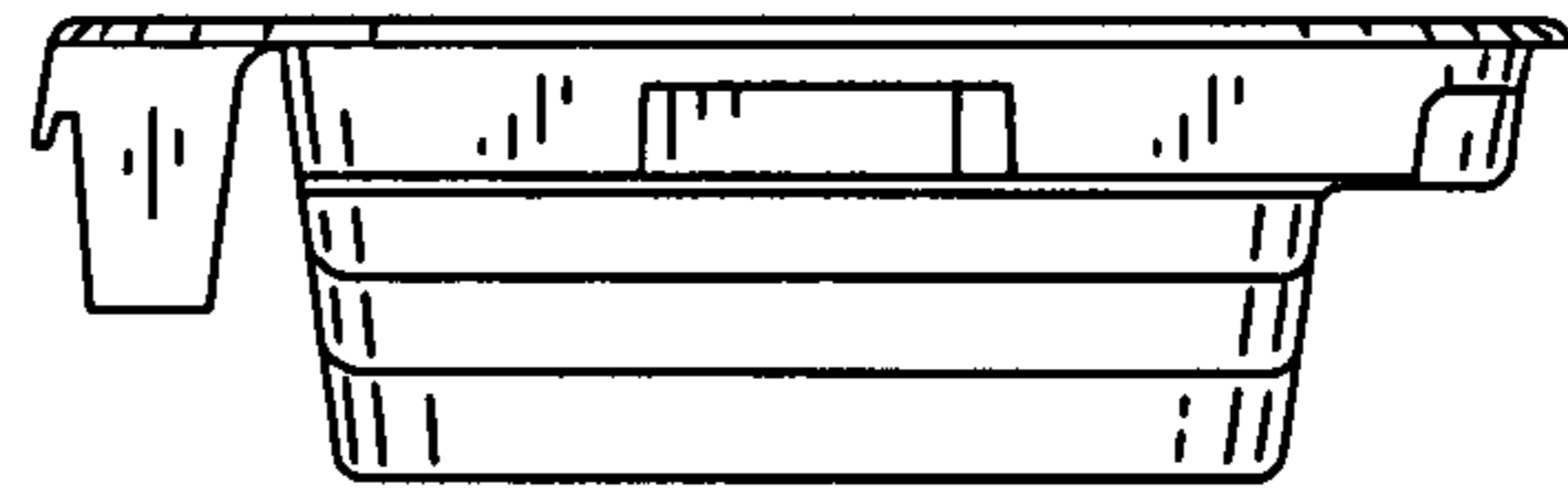
**1 Claim, 2 Drawing Sheets**



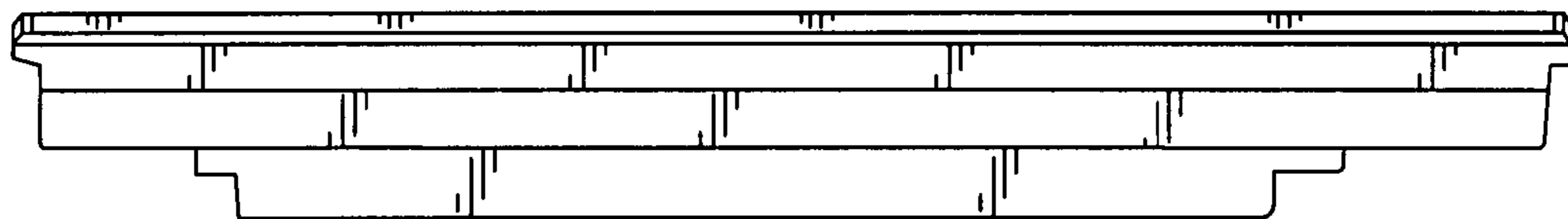




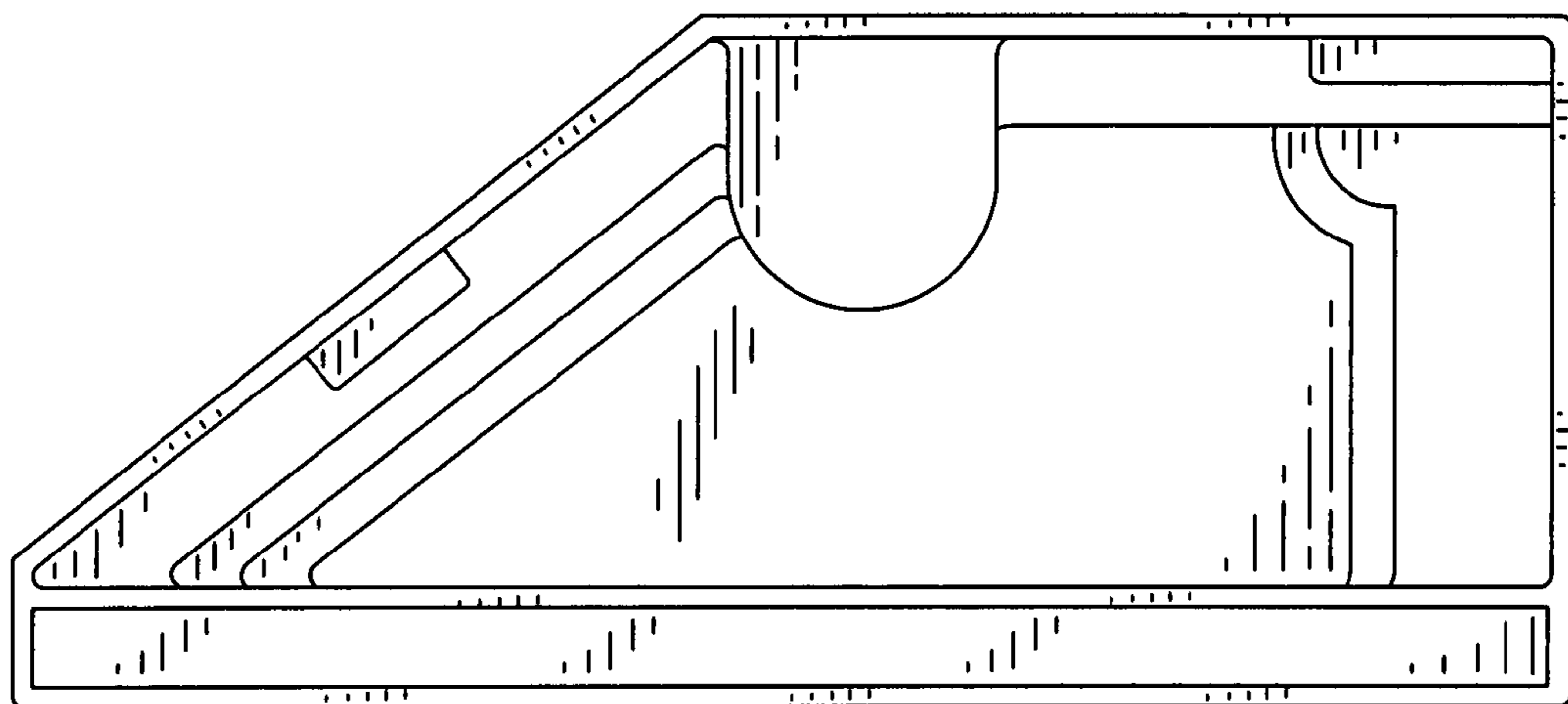
*Fig. 4*



*Fig. 5*



*Fig. 6*



*Fig. 7*