



US00D576724S

(12) **United States Design Patent**
Jensen et al.

(10) **Patent No.:** **US D576,724 S**

(45) **Date of Patent:** **** Sep. 9, 2008**

(54) **INHALER**

(75) Inventors: **Rasmus Løgstrup Jensen**, Aarhus (DK); **Carsten Pedersen**, Aarhus (DK)

(73) Assignee: **Bang & Olufsen Medicom A/S**, Struer (DK)

(**) Term: **14 Years**

(21) Appl. No.: **29/266,920**

(22) Filed: **Sep. 29, 2006**

(30) **Foreign Application Priority Data**

Sep. 7, 2006 (DK) DA 2006 00243

(51) **LOC (8) Cl.** **29-02**

(52) **U.S. Cl.** **D24/110**

(58) **Field of Classification Search** D24/110;
128/203.12, 203.15, 200.14, 200.18, 200.21,
128/200.23, 205.15, 205.21, 205.23

See application file for complete search history.

(56) **References Cited**

U.S. PATENT DOCUMENTS

D452,910	S *	1/2002	Braithwaite et al.	D24/110
D455,208	S *	4/2002	Bacon et al.	D24/110
D460,173	S *	7/2002	Harrison	D24/110
D496,456	S *	9/2004	Harvey et al.	D24/110
7,077,129	B2 *	7/2006	Anderson et al.	128/203.12
2003/0172927	A1 *	9/2003	Young et al.	128/203.15

* cited by examiner

Primary Examiner—Ian Simmons
Assistant Examiner—Christopher Lee

(74) *Attorney, Agent, or Firm*—Buchanan Ingersoll & Rooney PC

(57) **CLAIM**

The ornamental design for an inhaler, as shown and described.

DESCRIPTION

FIG. 1 is a front, side perspective view of an inhaler showing our new design;

FIG. 2 is a rear, side perspective view thereof;

FIG. 3 is a right side elevational view thereof;

FIG. 4 is a left side elevational view thereof;

FIG. 5 is a front elevational view thereof;

FIG. 6 is a rear elevational view thereof;

FIG. 7 is a bottom plan view thereof;

FIG. 8 is a top plan view thereof;

FIG. 9 is a front, side perspective view of the inhaler of FIG. 1 shown in an open position;

FIG. 10 is a rear, side perspective view thereof;

FIG. 11 is a right side elevational view thereof;

FIG. 12 is a left side elevational view thereof;

FIG. 13 is a front elevational view thereof showing our new design with a mouthpiece cap removed for ease of illustration;

FIG. 14 is a rear elevational view thereof;

FIG. 15 is a top plan view thereof; and,

FIG. 16 is a bottom plan view thereof.

1 Claim, 16 Drawing Sheets

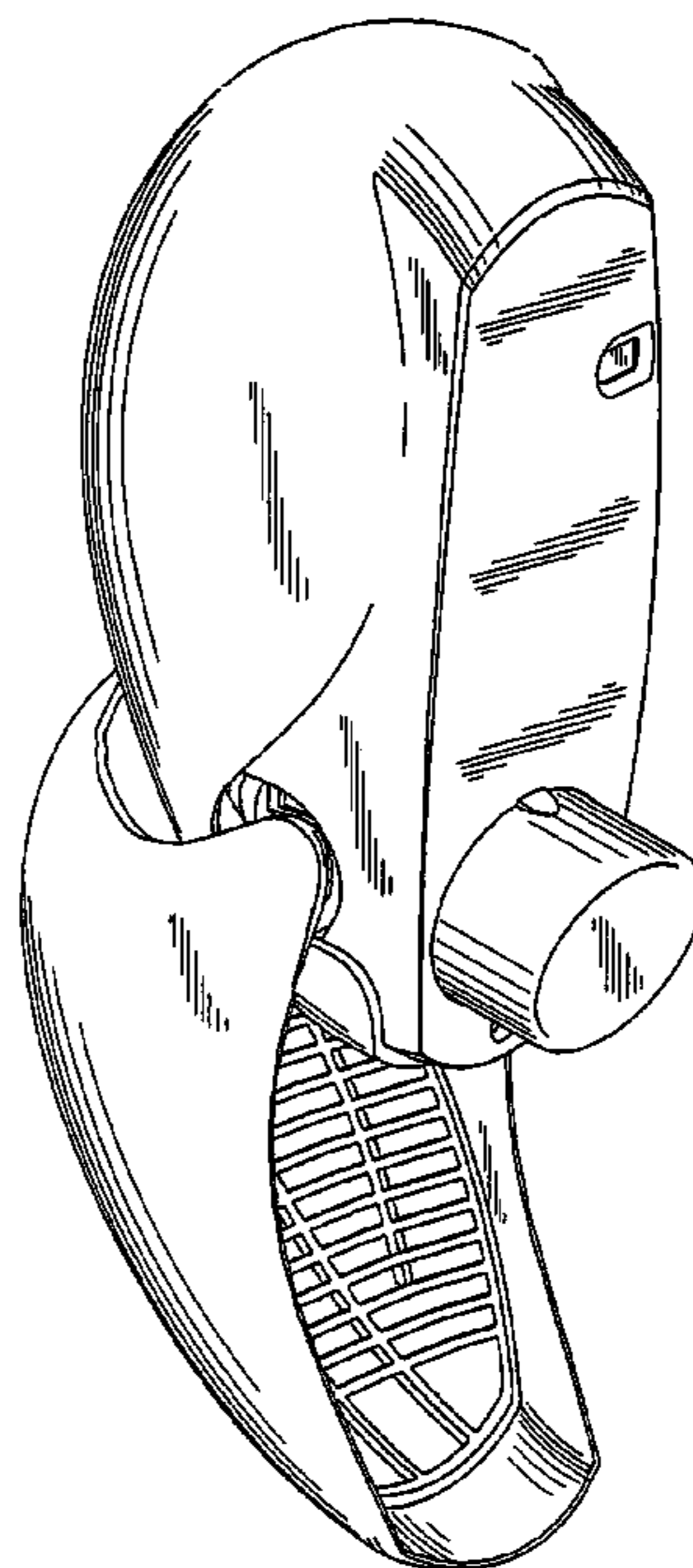
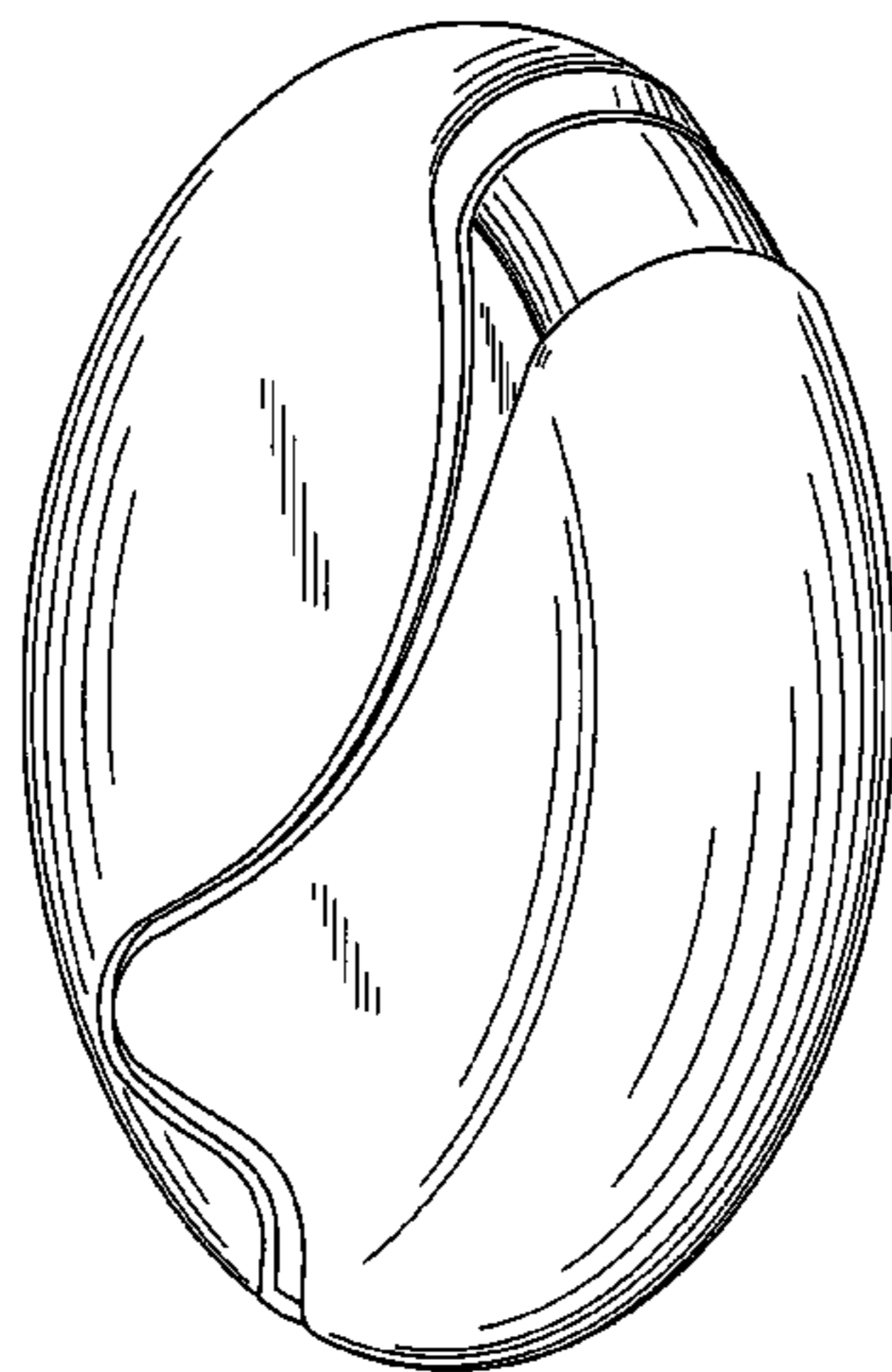

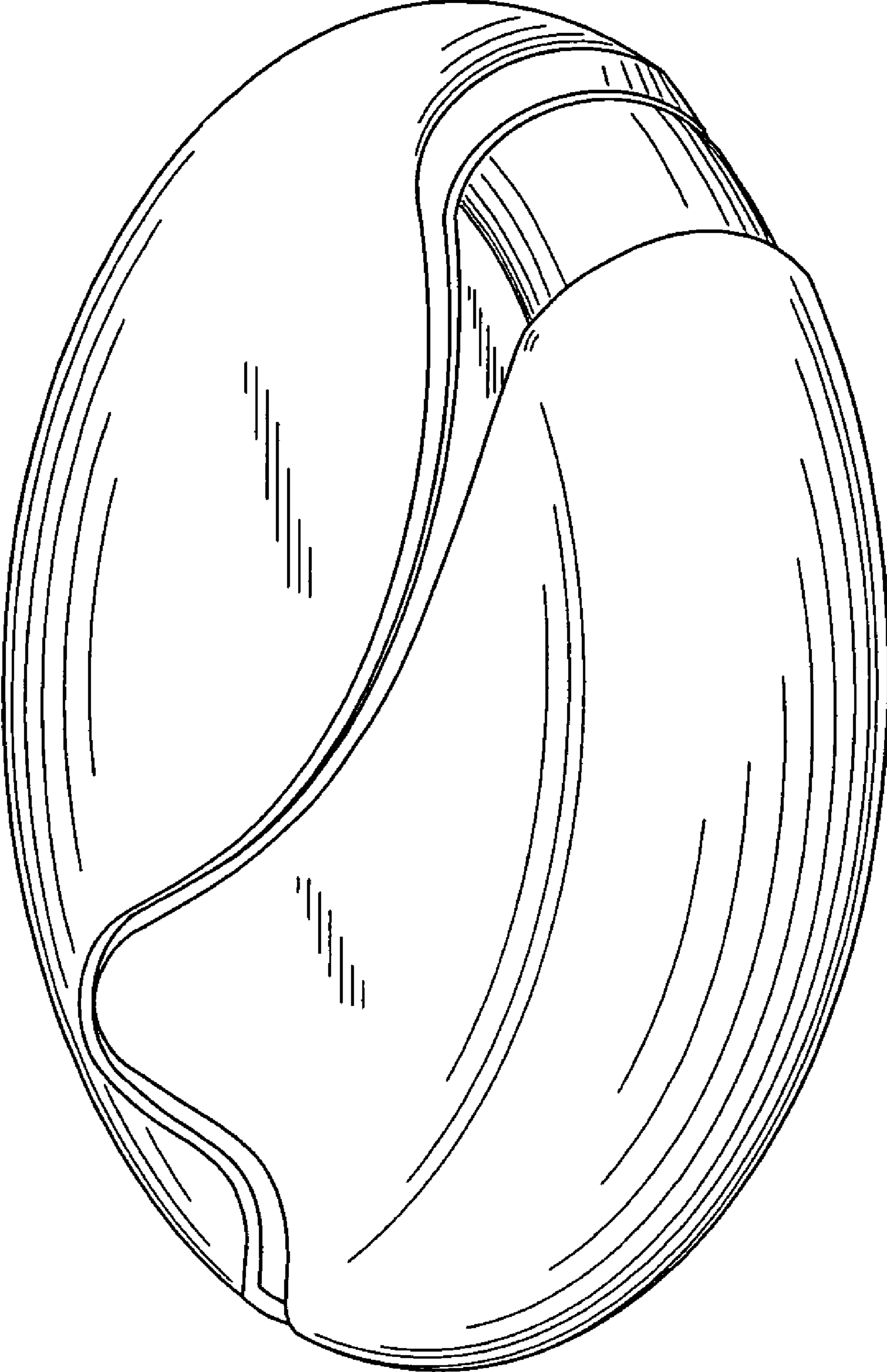

FIG. 1

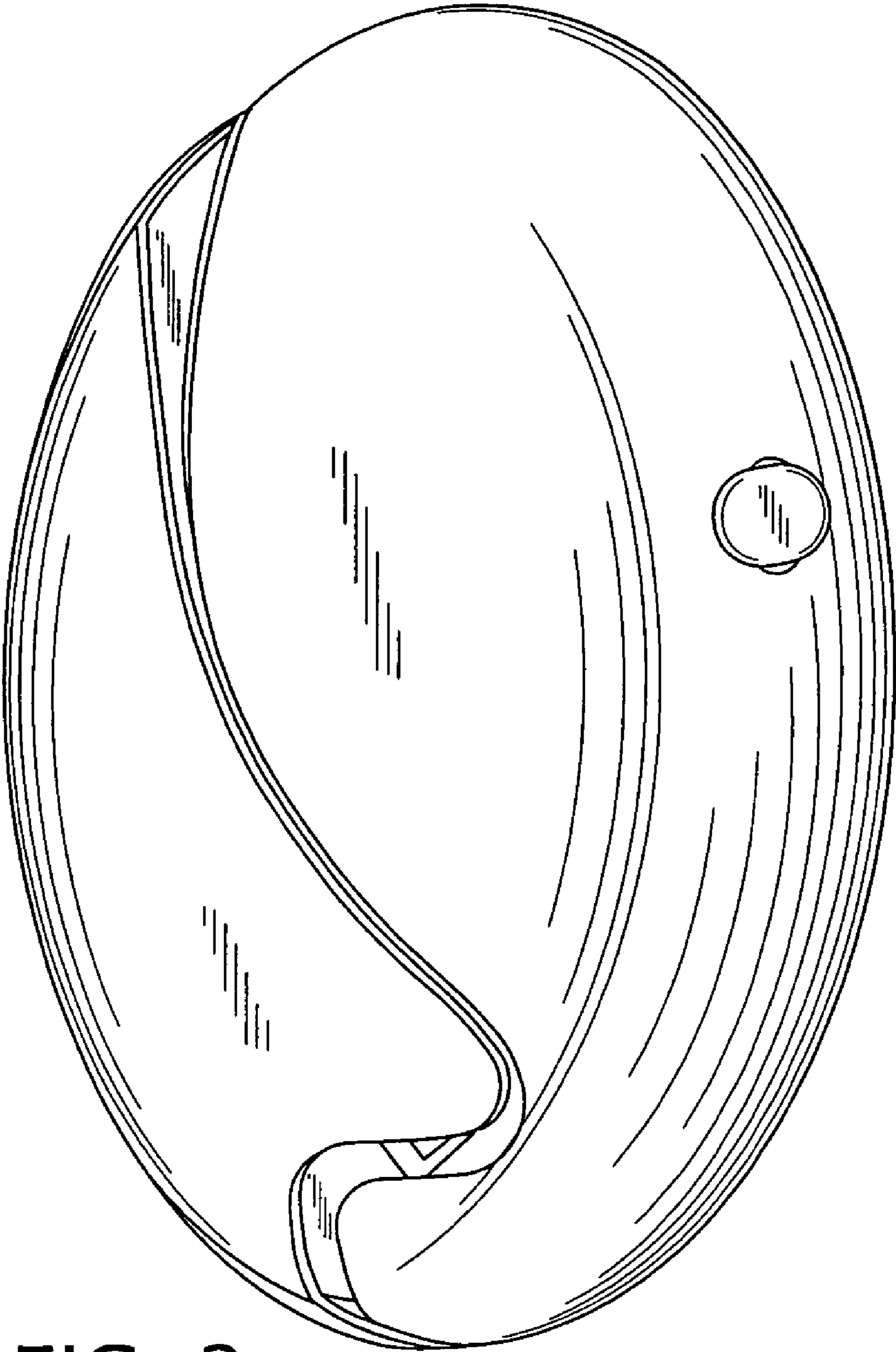

FIG. 2

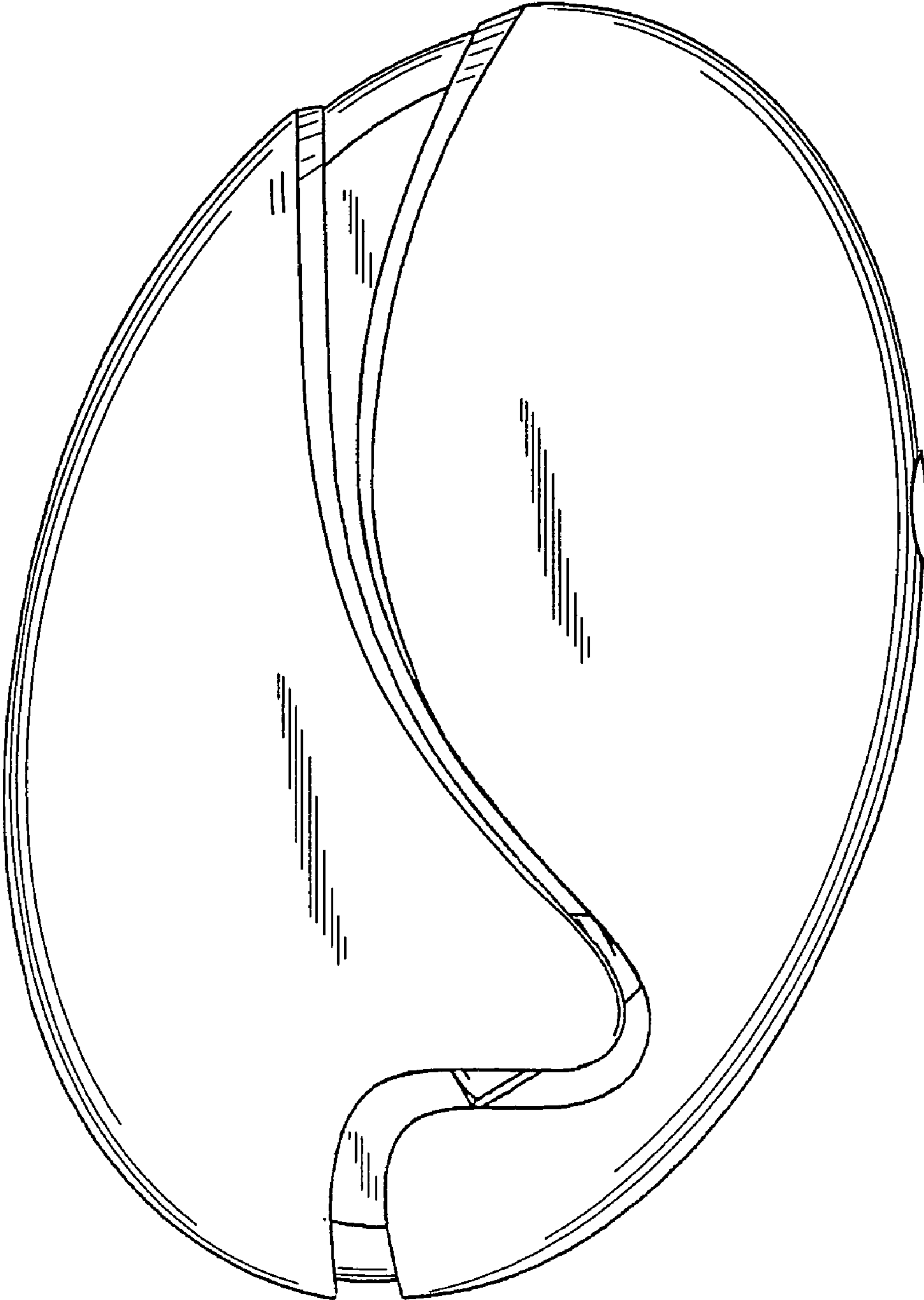

FIG. 3

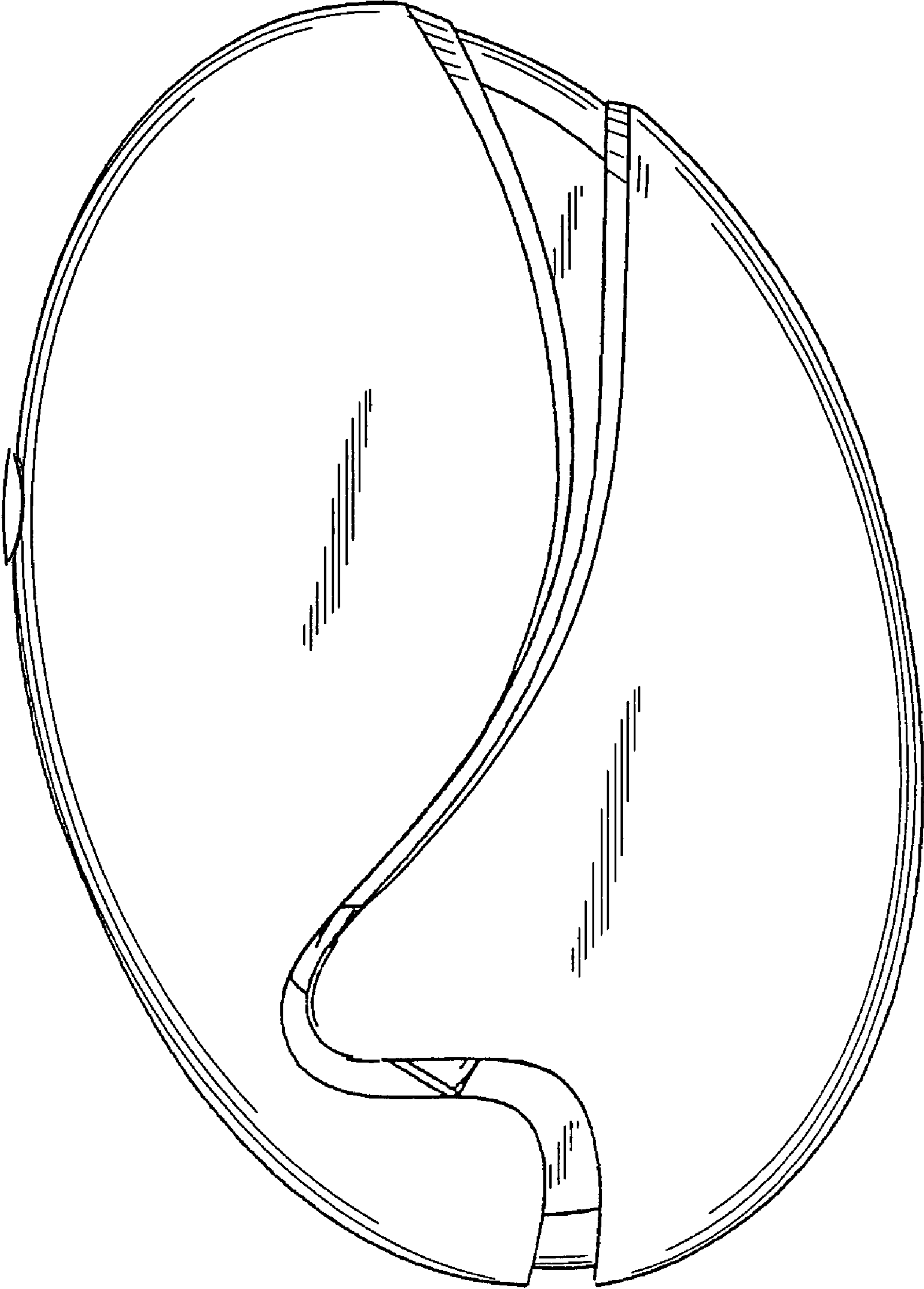

FIG. 4

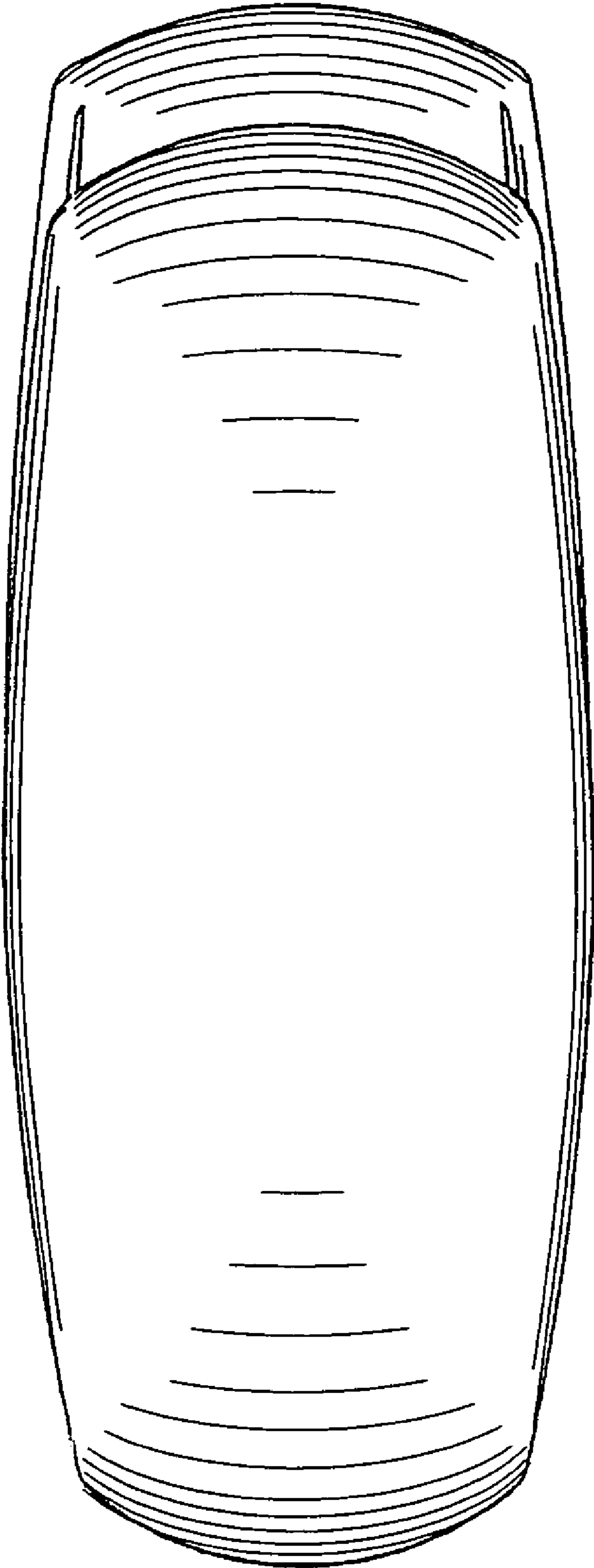

FIG. 5

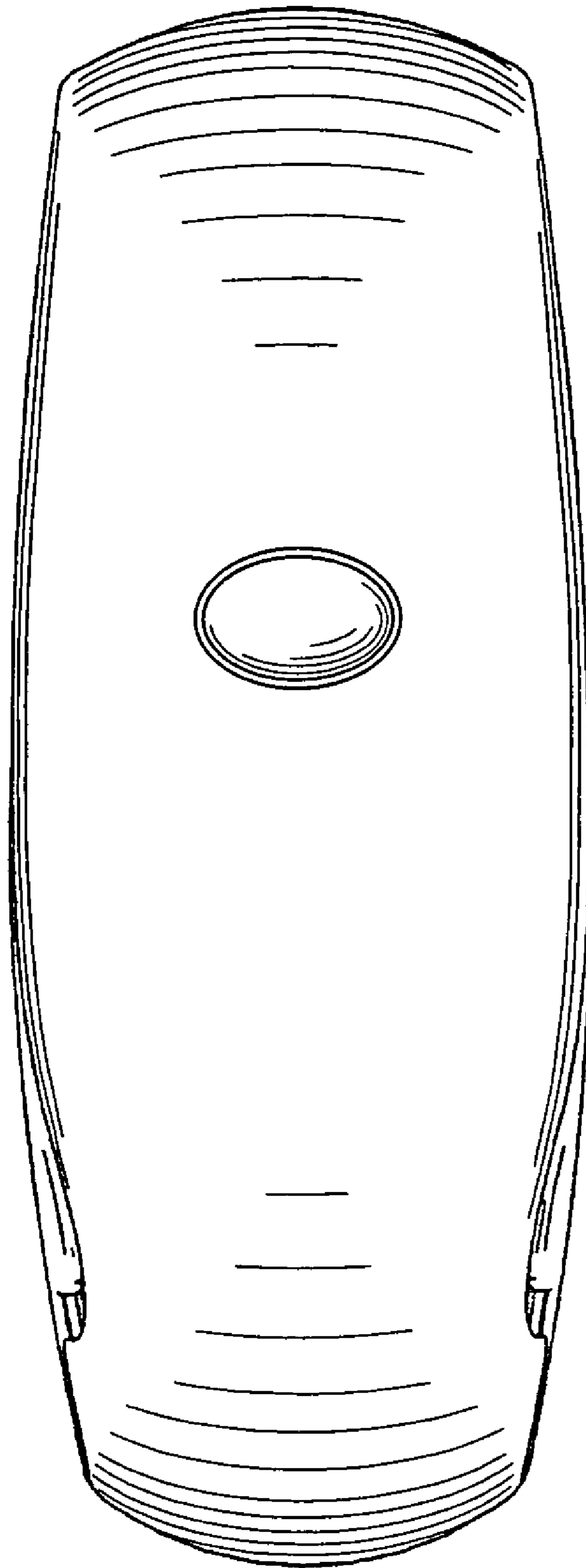

FIG. 6

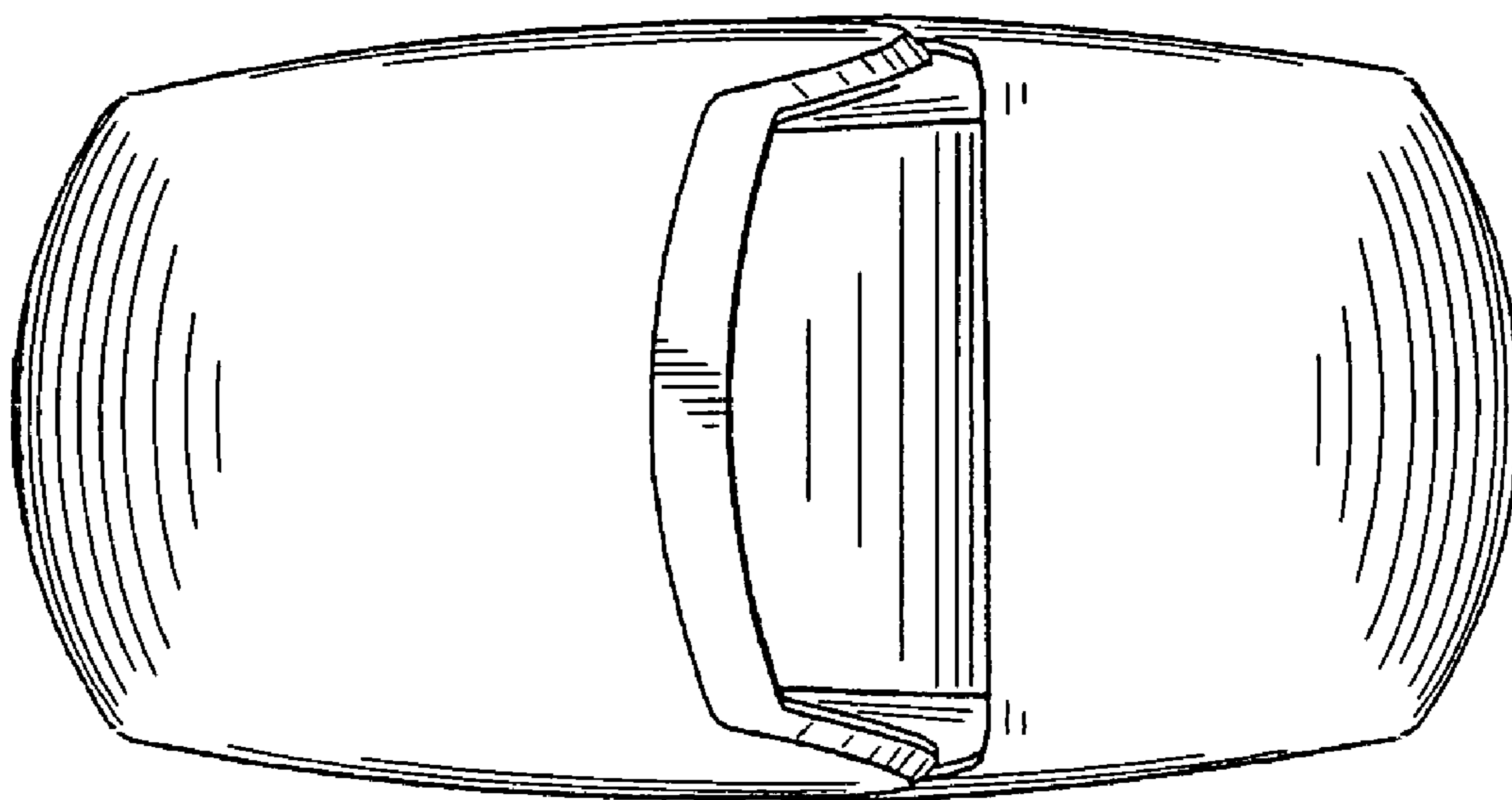

FIG. 7

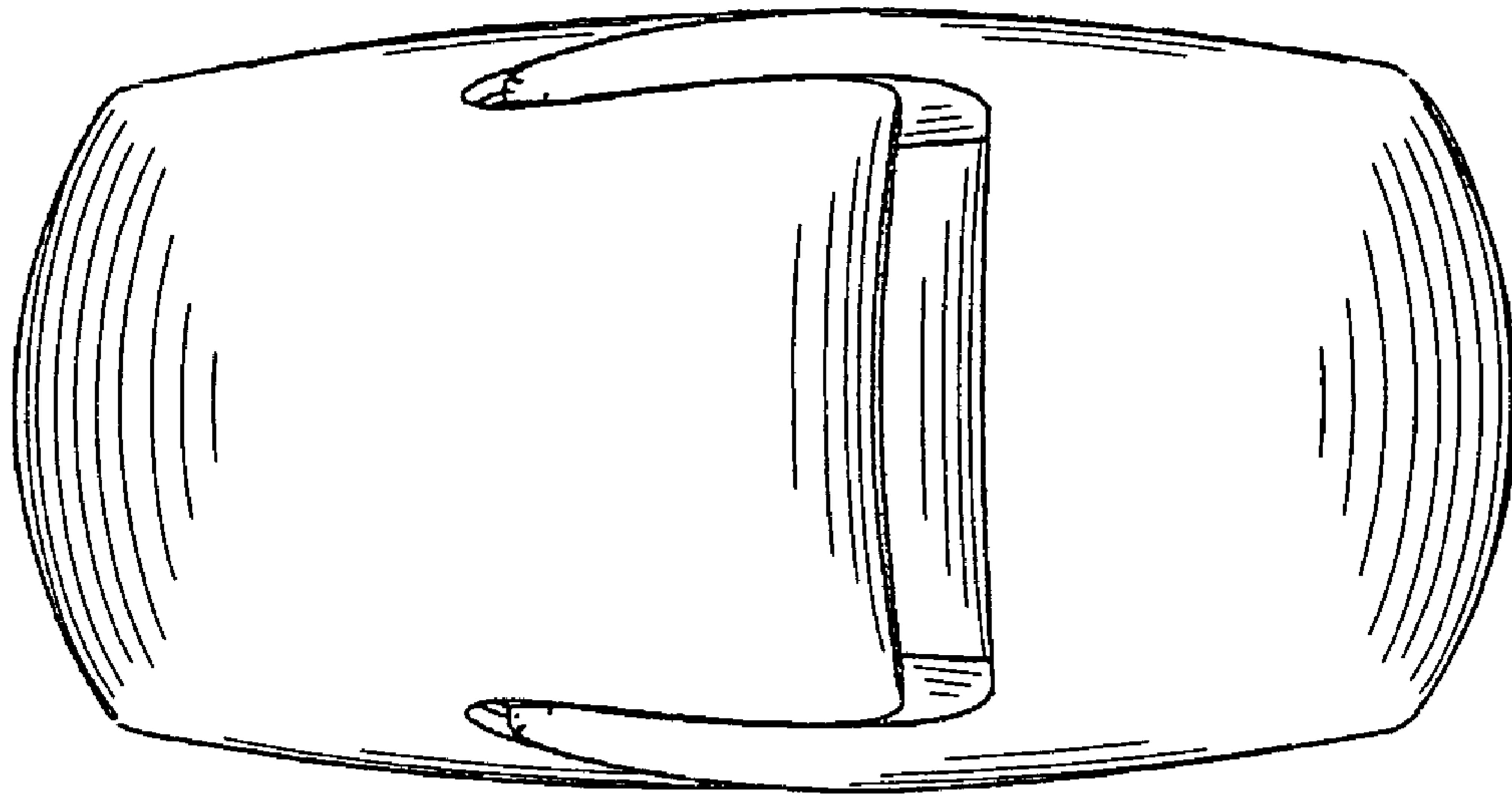

FIG. 8

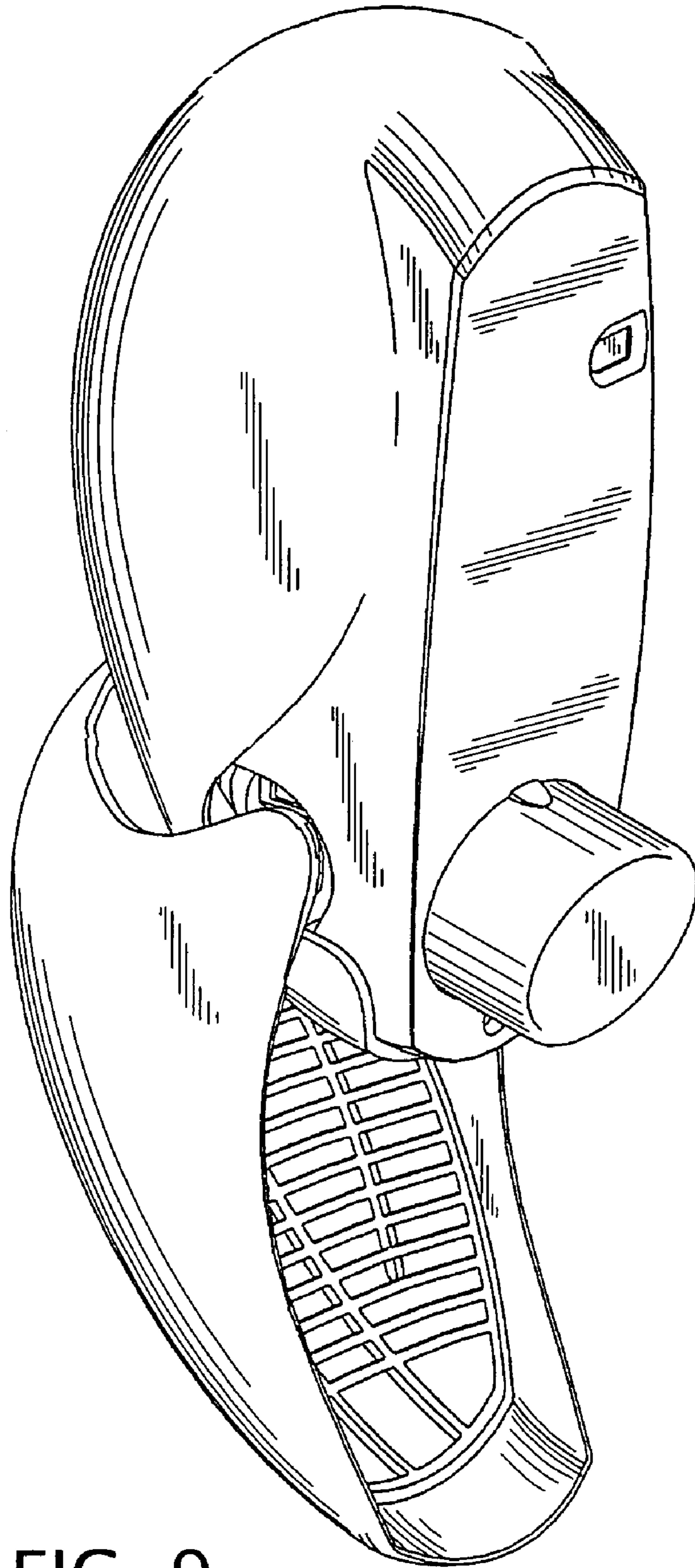

FIG. 9

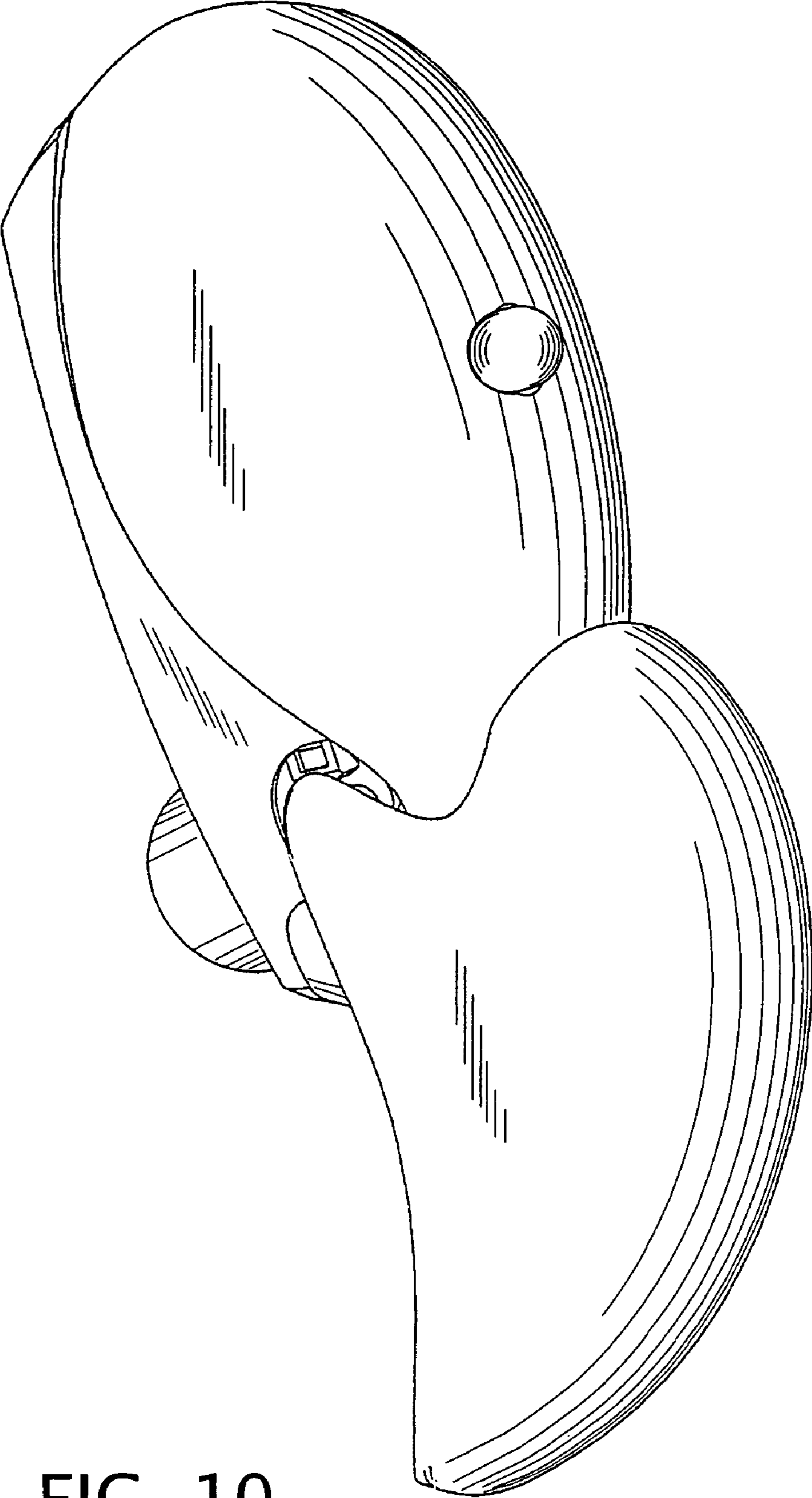

FIG. 10

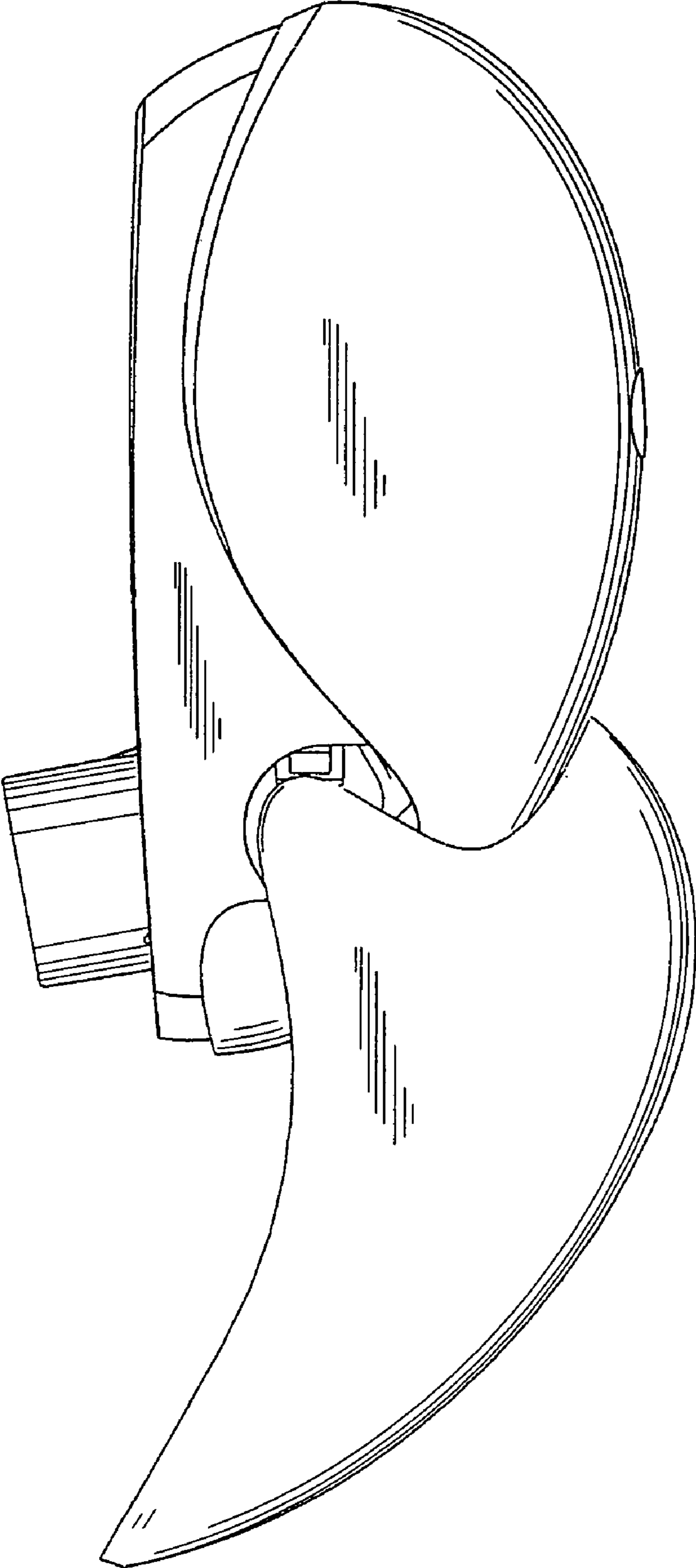

FIG. 11

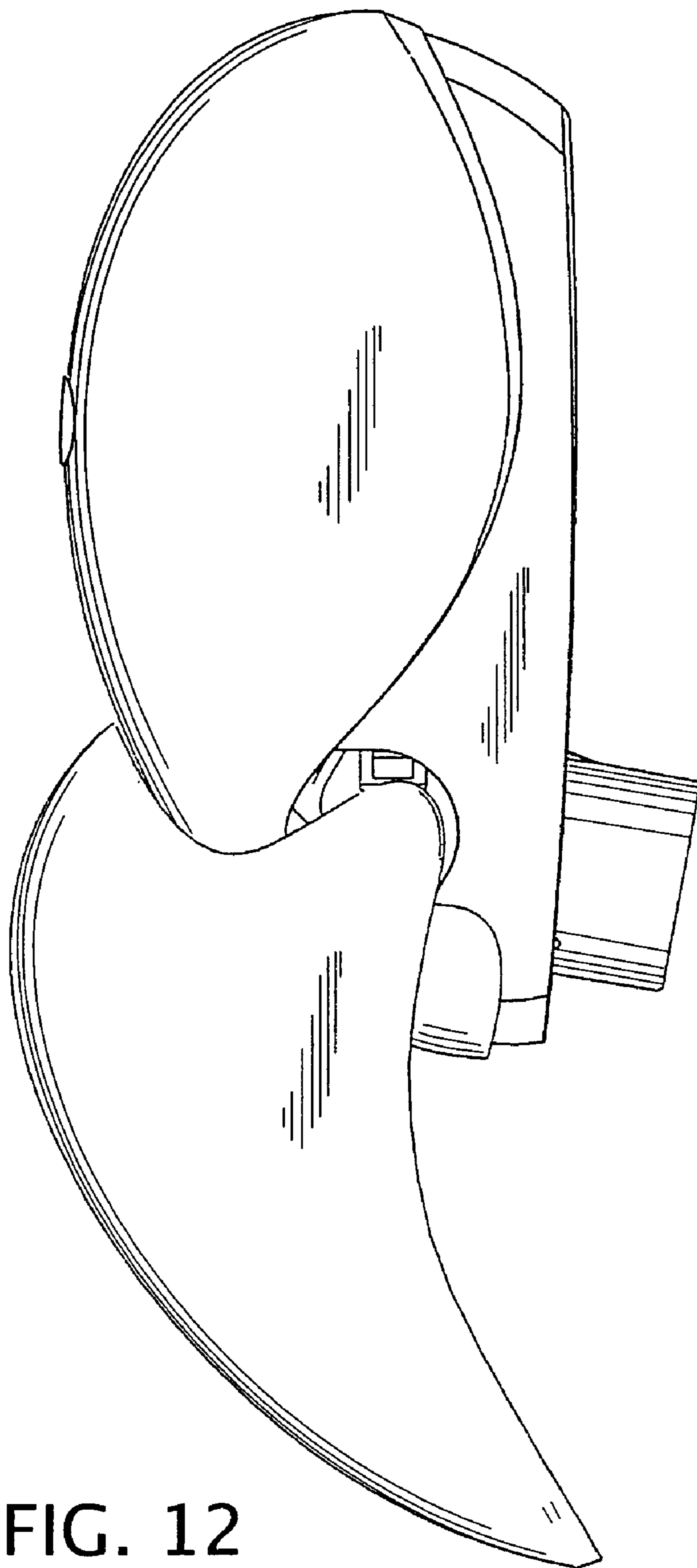

FIG. 12

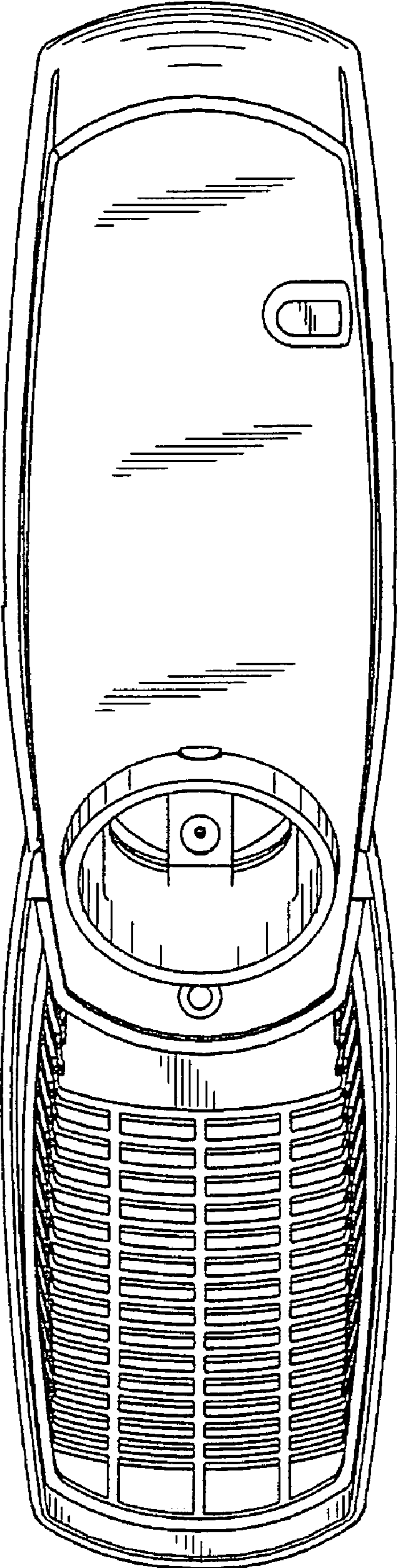

FIG. 13

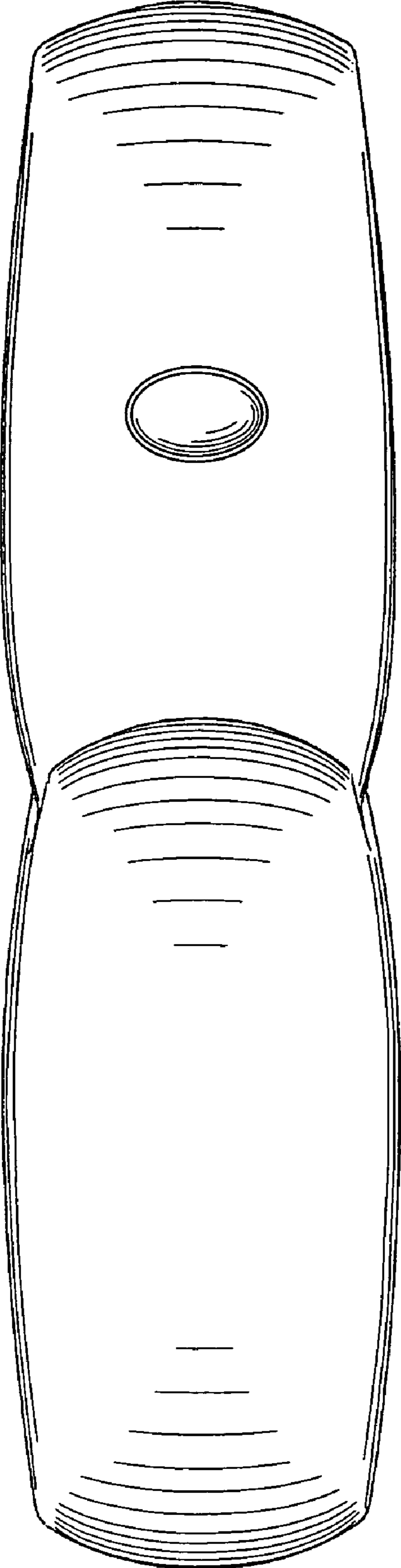

FIG. 14

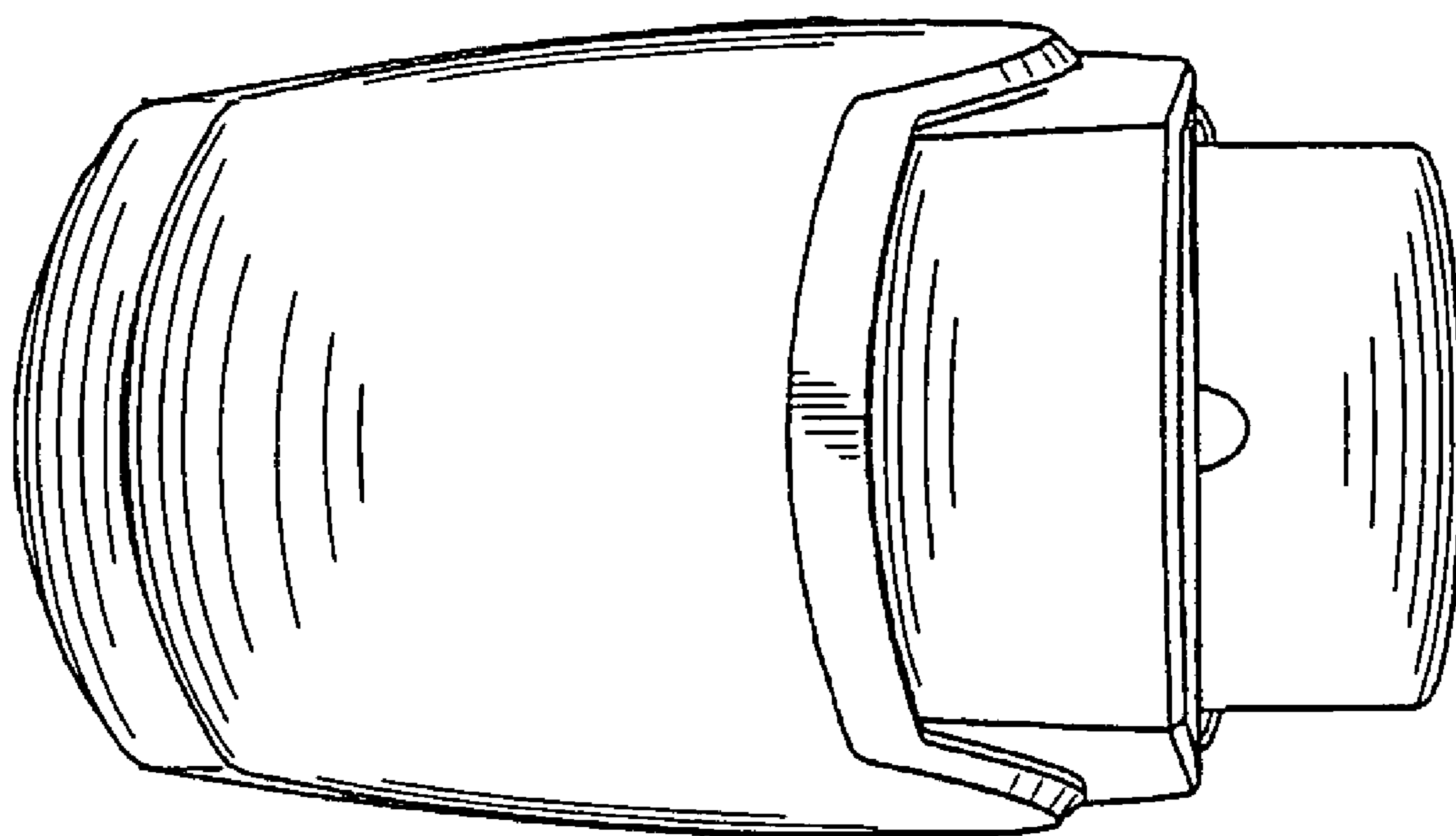

FIG. 15

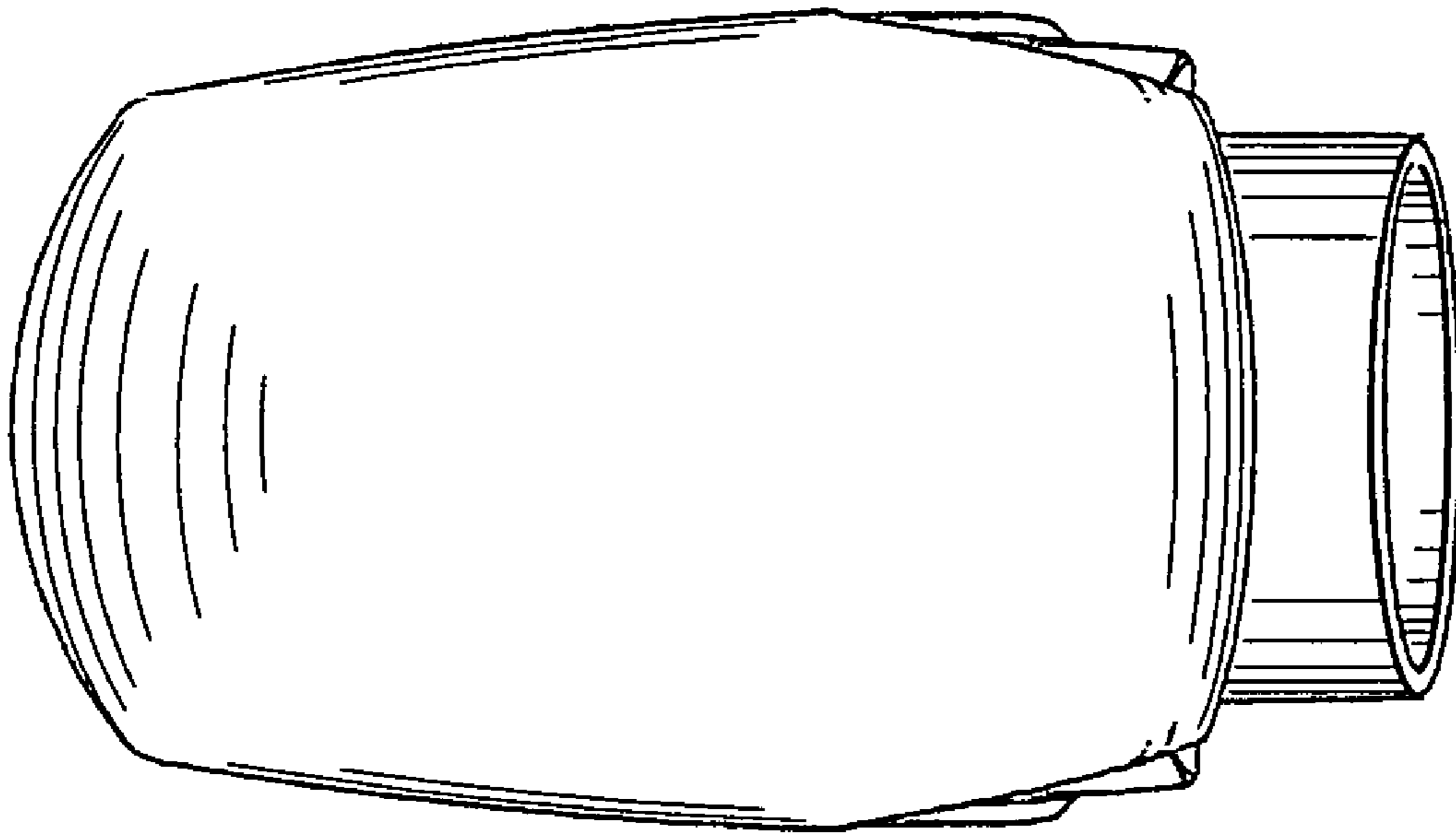

FIG. 16