



US00D576600S

(12) **United States Design Patent**
Kim et al.

(10) **Patent No.:** **US D576,600 S**
(45) **Date of Patent:** **** Sep. 9, 2008**

(54) **MOBILE PHONE**

(75) Inventors: **Kuk Hwan Kim**, Seoul (KR); **Nam Mi Kim**, Seoul (KR); **Chang Soo Lee**, Seoul (KR)

(73) Assignee: **Samsung Electronics Co., Ltd.**, Suwon (KR)

(**) Term: **14 Years**

(21) Appl. No.: **29/292,316**

(22) Filed: **Oct. 5, 2007**

(51) **LOC (8) Cl.** **14-03**

(52) **U.S. Cl.** **D14/138**

(58) **Field of Classification Search** D14/138,
D14/496, 341–347; 455/575.3, 575.1

See application file for complete search history.

(56) **References Cited**

U.S. PATENT DOCUMENTS

D292,706 S *	11/1987	Fischer	D14/345
D496,016 S *	9/2004	Hoo	D14/138
D498,735 S *	11/2004	Chen et al.	D14/138
D508,029 S *	8/2005	Lee	D14/138
D508,035 S *	8/2005	Kim et al.	D14/138
D513,505 S *	1/2006	Lee	D14/138
D521,480 S *	5/2006	Ou et al.	D14/138
D528,527 S *	9/2006	Lee et al.	D14/138
D537,059 S *	2/2007	Hwang	D14/138
D537,426 S *	2/2007	Arbisi	D14/138
D542,771 S *	5/2007	Cho et al.	D14/138
7,269,443 B2 *	9/2007	Park et al.	455/556.2
D552,055 S *	10/2007	Lheem	D14/138
D559,217 S *	1/2008	Helin et al.	D14/138
D559,825 S *	1/2008	Park et al.	D14/138
D560,637 S *	1/2008	Yang et al.	D14/138
D561,719 S *	2/2008	Cho	D14/138
D563,376 S *	3/2008	Arnholt et al.	D14/138
D563,377 S *	3/2008	Price et al.	D14/138

D563,924 S *	3/2008	Arnold et al.	D14/138
D566,087 S *	4/2008	Choi	D14/138
D568,863 S *	5/2008	Lee et al.	D14/138
2004/0132512 A1 *	7/2004	Yajima	455/575.3
2005/0245296 A1 *	11/2005	Hong et al.	455/575.3
2007/0178949 A1 *	8/2007	Sato et al.	455/575.3
2007/0281759 A1 *	12/2007	Choi	455/575.1

OTHER PUBLICATIONS

Samsung A500 telephone, announced 2002, [online], [site visited May 24, 2008]. Available from Internet ,<URL: <http://www.gsmarena.com>>.*

LG KF300 telephone, announced Apr. 2008, [online], [site visited May 24, 2008]. Available from Internet ,<URL: <http://www.gsmarena.com>>.*

Haier M1100 telephone, announced 2005, [online], [site visited May 24, 2008]. Available from Internet ,<URL: <http://www.gsmarena.com>>.*

* cited by examiner

Primary Examiner—Jeffrey D Asch

(74) *Attorney, Agent, or Firm*—Ladas and Parry LLP

(57) **CLAIM**

We claim the ornamental design for mobile phone, as shown.

DESCRIPTION

FIG. 1 is a front/left-side/top perspective view of a mobile phone showing our new design;

FIG. 2 is a front-side elevational view thereof;

FIG. 3 is a rear-side elevational view thereof;

FIG. 4 is a left-side elevational view thereof;

FIG. 5 is a right-side elevational view thereof;

FIG. 6 is a top-side elevational view thereof;

FIG. 7 is a bottom-side elevational view thereof; and,

FIG. 8 is a front/left-side/top perspective view showing our new design with the folder in the open position.

1 Claim, 7 Drawing Sheets

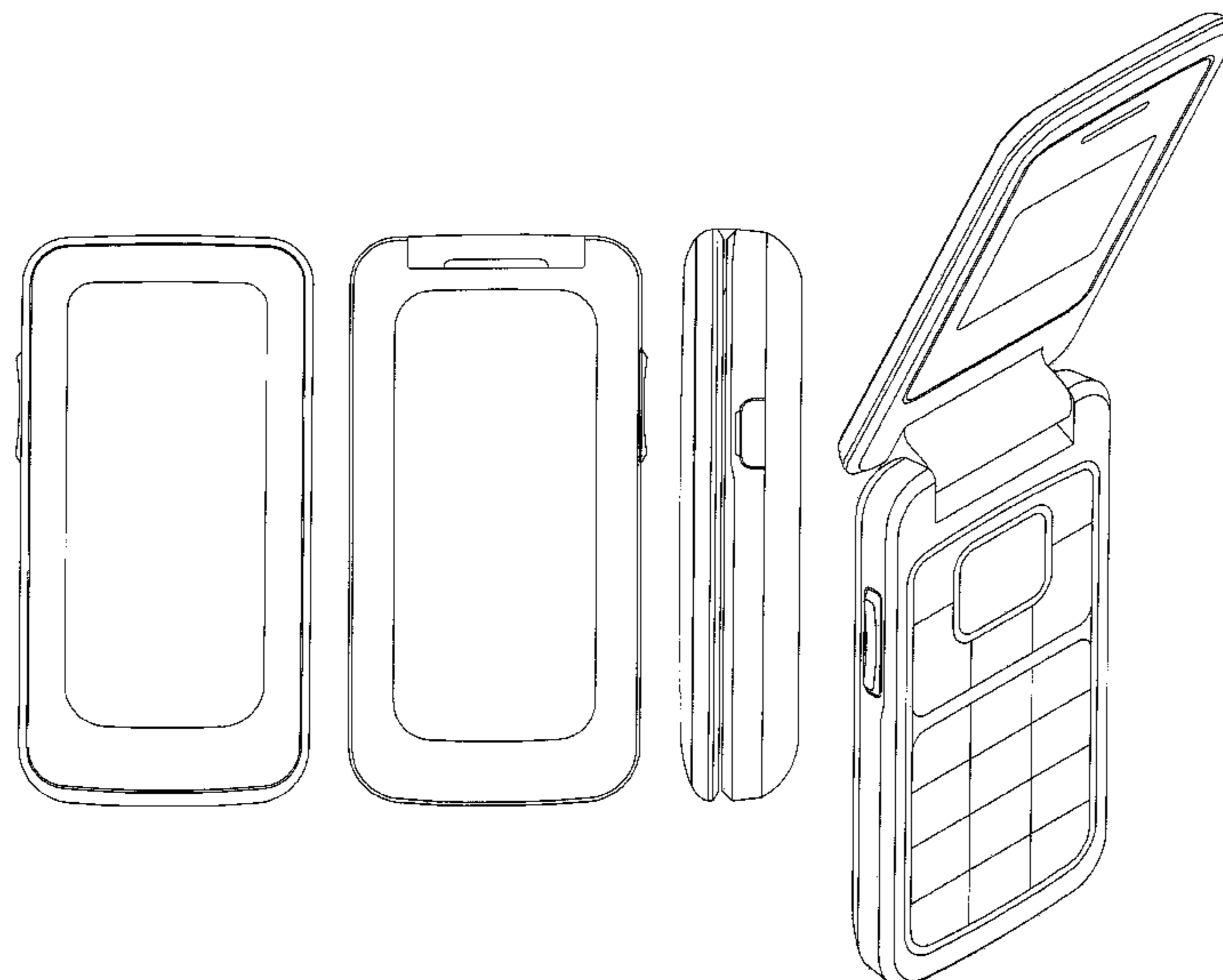

FIG. 1

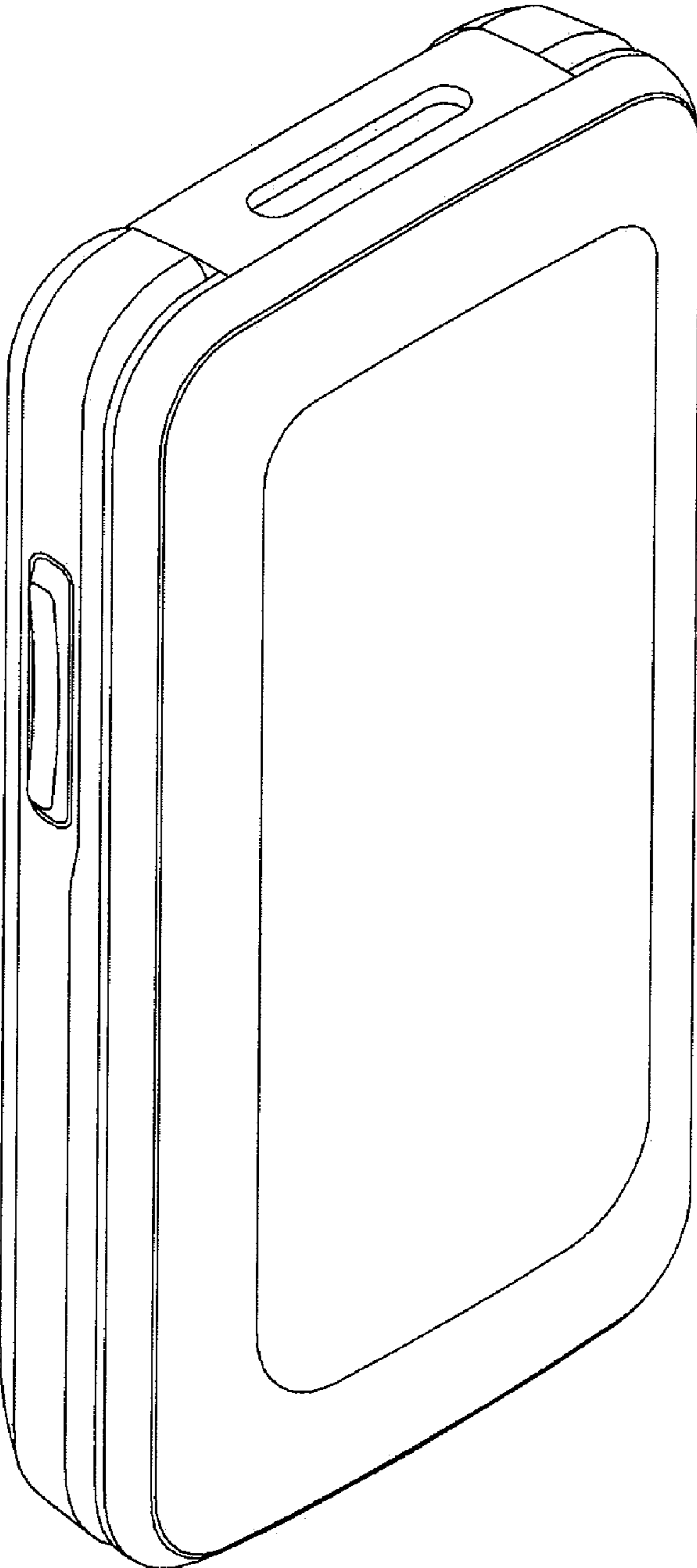

FIG. 2

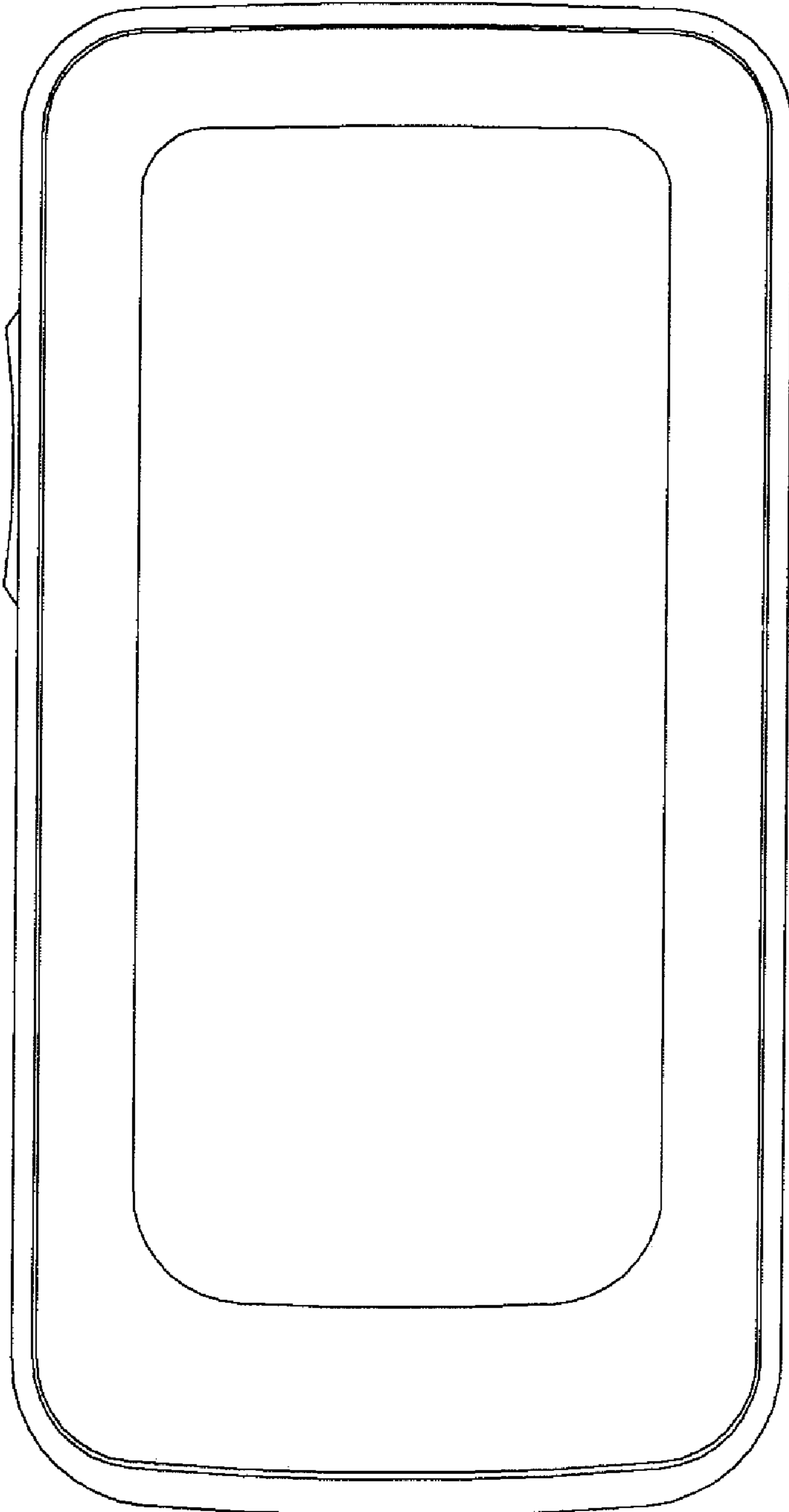

FIG. 3

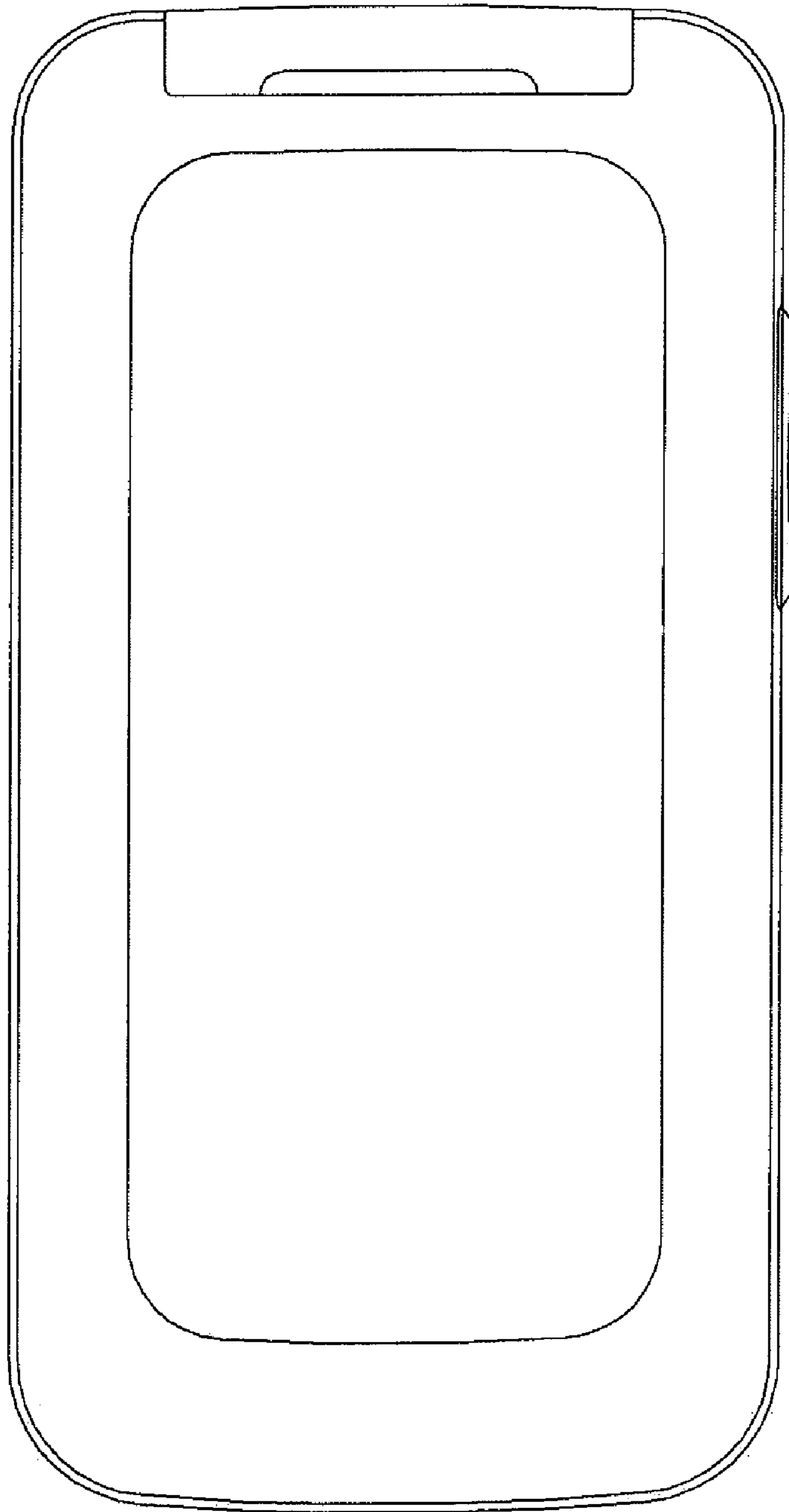

FIG. 4

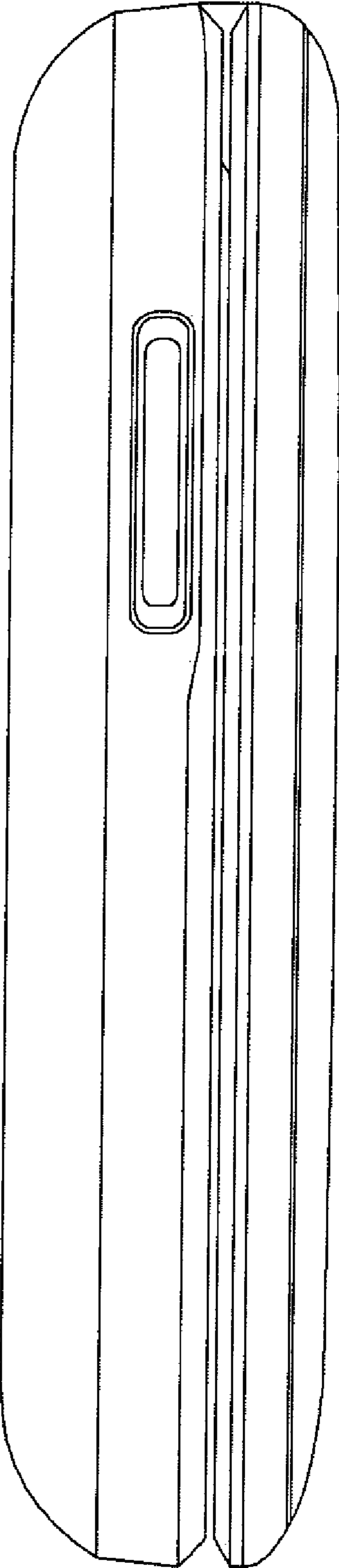

FIG. 5

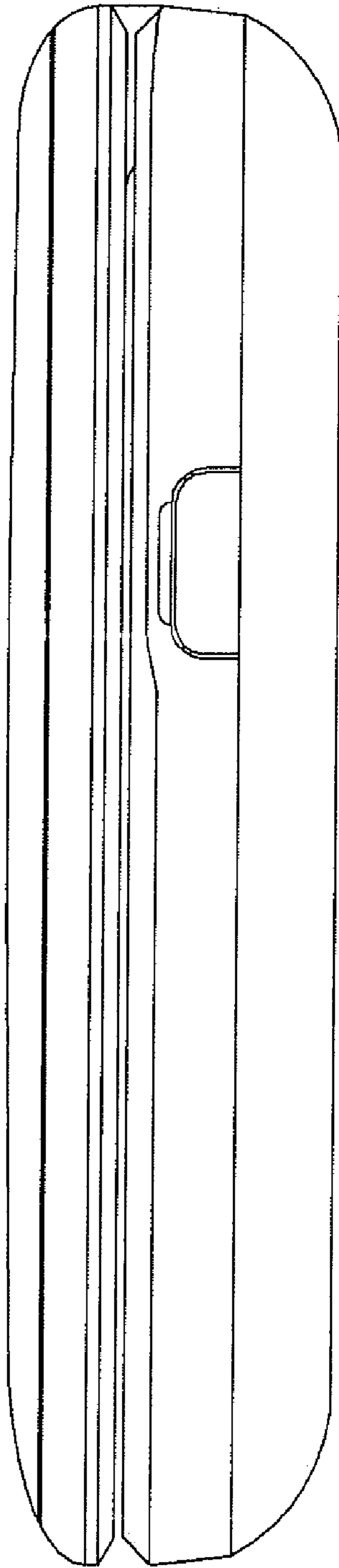

FIG. 6

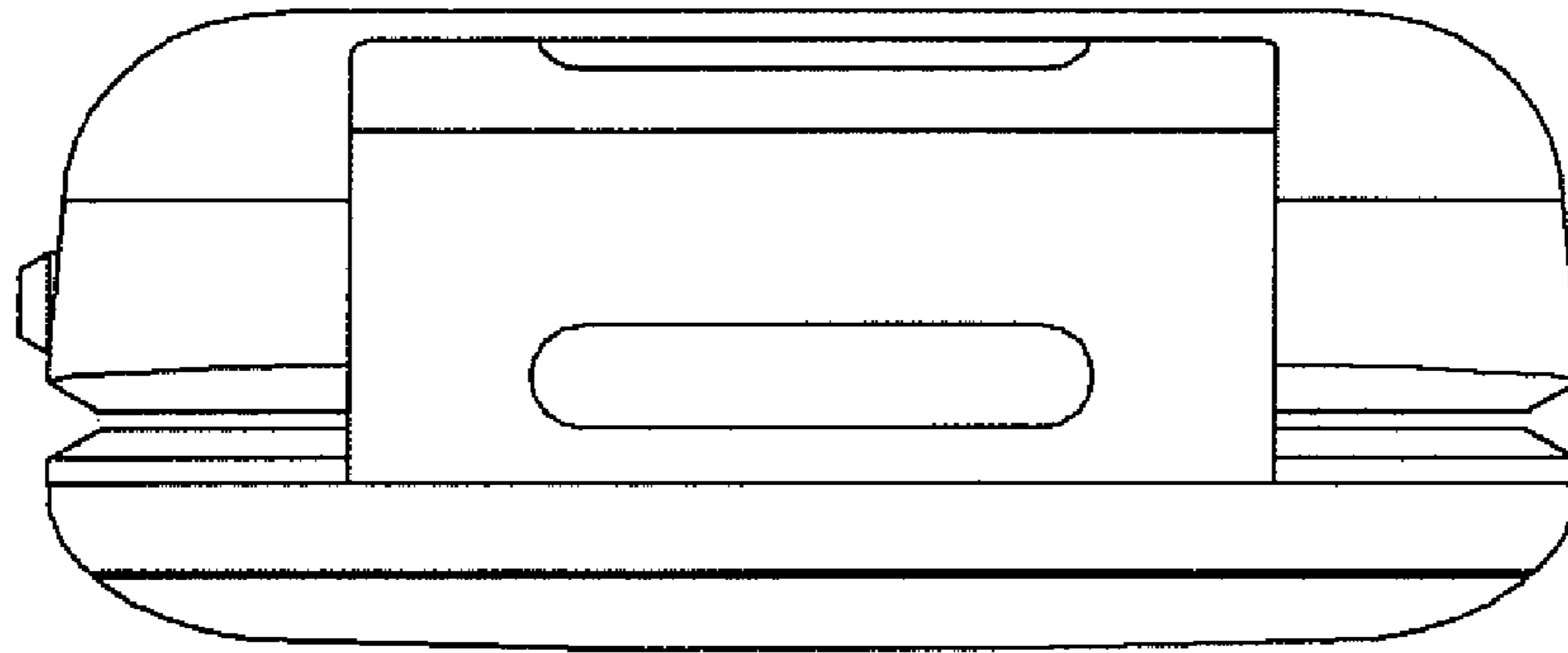

FIG. 7

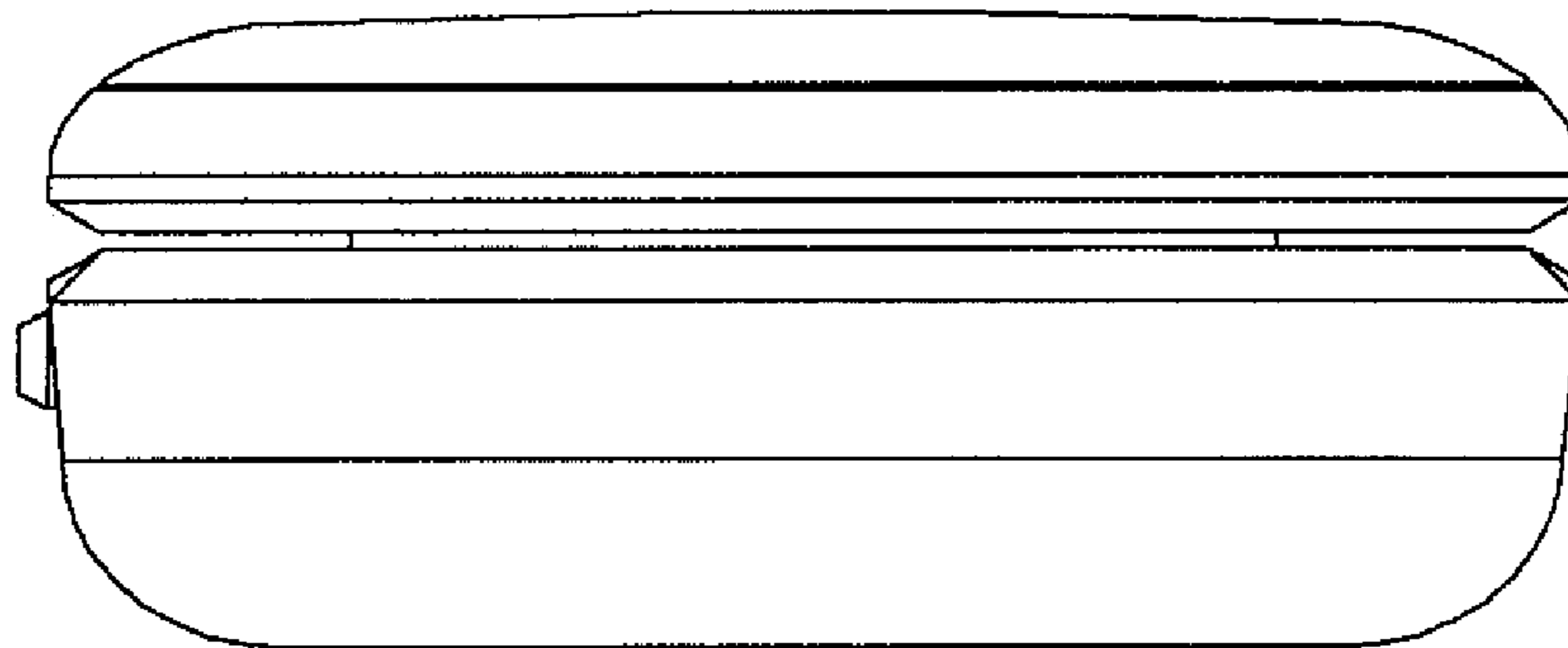

FIG. 8

