



US00D576599S

(12) **United States Design Patent**
Han et al.

(10) **Patent No.:** **US D576,599 S**
(45) **Date of Patent:** **** Sep. 9, 2008**

(54) **MOBILE PHONE**

(75) Inventors: **Kyung Jin Han**, Seoul (KR); **Nam Mi Kim**, Seoul (KR); **Chang Soo Lee**, Seoul (KR)

(73) Assignee: **Samsung Electronics Co., Ltd.**, Suwon (KR)

(**) Term: **14 Years**

(21) Appl. No.: **29/292,314**

(22) Filed: **Oct. 5, 2007**

(51) **LOC (8) Cl.** **14-03**

(52) **U.S. Cl.** **D14/138**

(58) **Field of Classification Search** D14/138,
D14/496, 341-347; 455/575.3, 575.1
See application file for complete search history.

(56) **References Cited**

U.S. PATENT DOCUMENTS

| | | | | | | |
|----------|---|---|---------|---------------|-------|---------|
| D452,250 | S | * | 12/2001 | Chan | | D14/496 |
| D486,809 | S | * | 2/2004 | Hwang | | D14/138 |
| D491,906 | S | * | 6/2004 | Okamatsu | | D14/138 |
| D491,907 | S | * | 6/2004 | Ogawa | | D14/138 |
| D501,189 | S | * | 1/2005 | Lodato et al. | | D14/138 |
| D505,124 | S | * | 5/2005 | Takada | | D14/138 |
| D507,553 | S | * | 7/2005 | Gotou et al. | | D14/138 |
| D511,509 | S | * | 11/2005 | Kim et al. | | D14/138 |
| D517,517 | S | * | 3/2006 | Li et al. | | D14/138 |
| D534,143 | S | * | 12/2006 | Lheem | | D14/138 |
| D535,959 | S | * | 1/2007 | Cho et al. | | D14/138 |
| D536,319 | S | * | 2/2007 | Kim | | D14/138 |
| D536,686 | S | * | 2/2007 | Miyata | | D14/138 |
| D537,059 | S | * | 2/2007 | Hwang | | D14/138 |
| D540,767 | S | * | 4/2007 | Kim et al. | | D14/138 |
| D553,126 | S | * | 10/2007 | Katayama | | D14/248 |
| D556,719 | S | * | 12/2007 | Lee | | D14/138 |
| D556,720 | S | * | 12/2007 | Lee | | D14/138 |
| D557,232 | S | * | 12/2007 | Lee | | D14/138 |
| D563,434 | S | * | 3/2008 | Dai | | D14/496 |
| D566,081 | S | * | 4/2008 | Kim et al. | | D14/138 |
| D566,083 | S | * | 4/2008 | Kim et al. | | D14/138 |
| D566,084 | S | * | 4/2008 | Oh et al. | | D14/138 |

| | | | | | | |
|--------------|----|---|--------|--------------|-------|-----------|
| D567,781 | S | * | 4/2008 | Hwang et al. | | D14/138 |
| D568,278 | S | * | 5/2008 | Kim et al. | | D14/138 |
| 2006/0105820 | A1 | * | 5/2006 | Takahashi | | 455/575.1 |

OTHER PUBLICATIONS

Samsung E230 telephone, announced Aug. 2007, [online], [site visited May 7, 2008]. Available from Internet ,<URL: http://www.gsmarena.com>.*

Motorola V220 telephone, announced 4th quarter 2003, [online], [site visited May 7, 2008]. Available from Internet ,<URL: http://www.gsmarena.com>.*

Alcatel OT 835 telephone, announced 1st quarter 2004, [online], [site visited May 7, 2008]. Available from Internet ,<URL: http://www.gsmarena.com>.*

Philips 588 telephone, announced May 2006, [online], [site visited May 7, 2008]. Available from Internet ,<URL: http://www.gsmarena.com>.*

BenQ T51 telephone, announced Aug. 2007, [online], [site visited May 7, 2008]. Available from Internet ,<URL: http://www.gsmarena.com>.*

VK Mobile VK3100 telephone, announced 4th quarter 2005, [online], [site visited May 7, 2008]. Available from Internet ,<URL: http://www.gsmarena.com>.*

(Continued)

Primary Examiner—Jeffrey D Asch

(74) *Attorney, Agent, or Firm*—Ladas and Parry LLP

(57) **CLAIM**

I/we claim the ornamental design for mobile phone, as shown.

DESCRIPTION

FIG. 1 is a front/left-side/top perspective view of a mobile phone showing our new design;

FIG. 2 is a front-side elevational view thereof;

FIG. 3 is a rear-side elevational view thereof;

FIG. 4 is a left-side elevational view thereof;

FIG. 5 is a right-side elevational view thereof;

FIG. 6 is a top-side elevational view thereof;

FIG. 7 is a bottom-side elevational view thereof; and,

FIG. 8 is a front/left-side/top perspective view thereof showing the folder is opened.

1 Claim, 7 Drawing Sheets

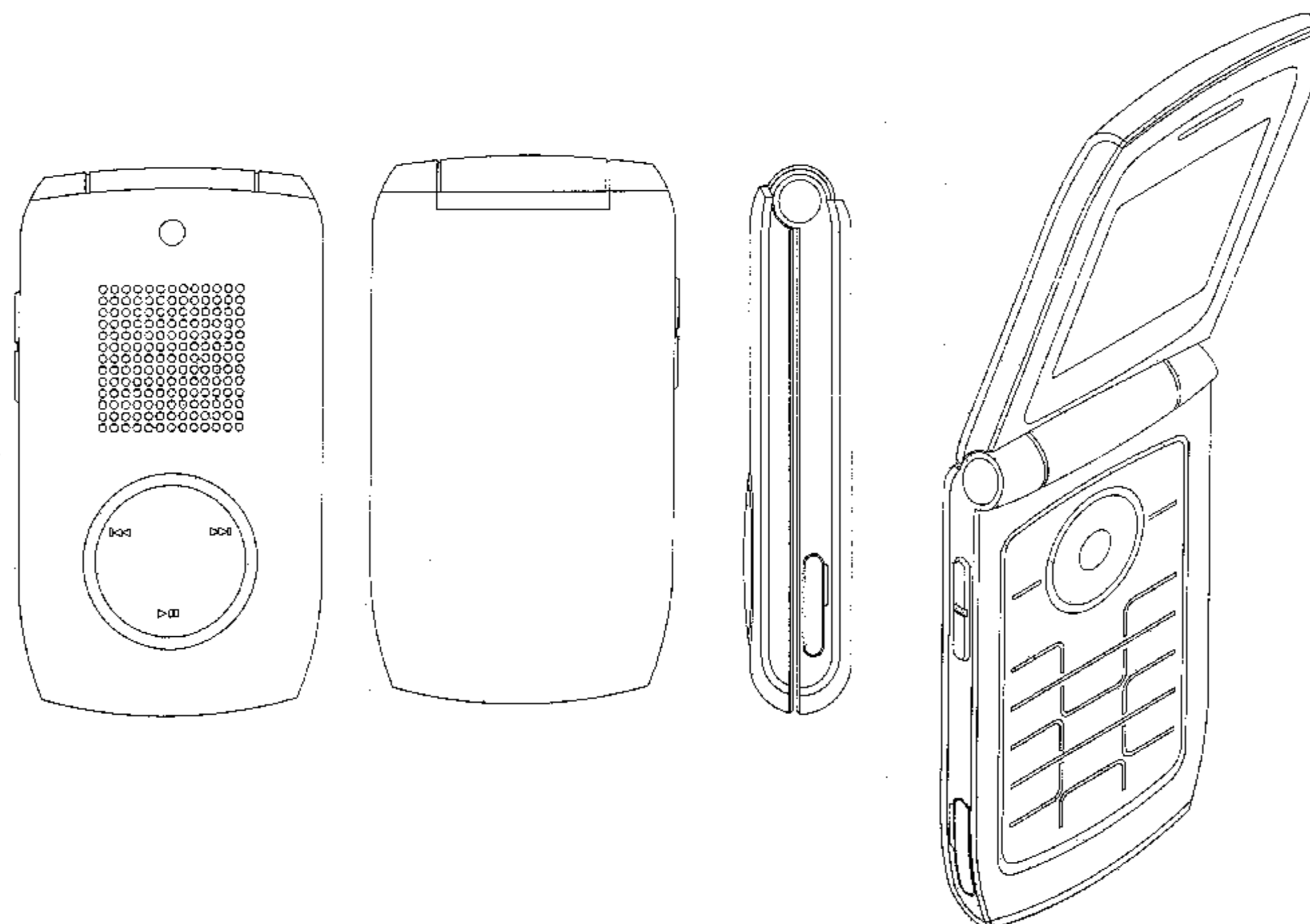

OTHER PUBLICATIONS

Bird M01 telephone, announced 2007, [online], [site visited May 7, 2008]. Available from Internet ,<URL: <http://www.gsmarena.com>>.*

Sagem MY C-5w telephone, announced 3rd quarter 2003, [online], [site visited May 7, 2008]. Available from Internet ,<URL: <http://www.gsmarena.com>>.*

* cited by examiner

FIG. 1

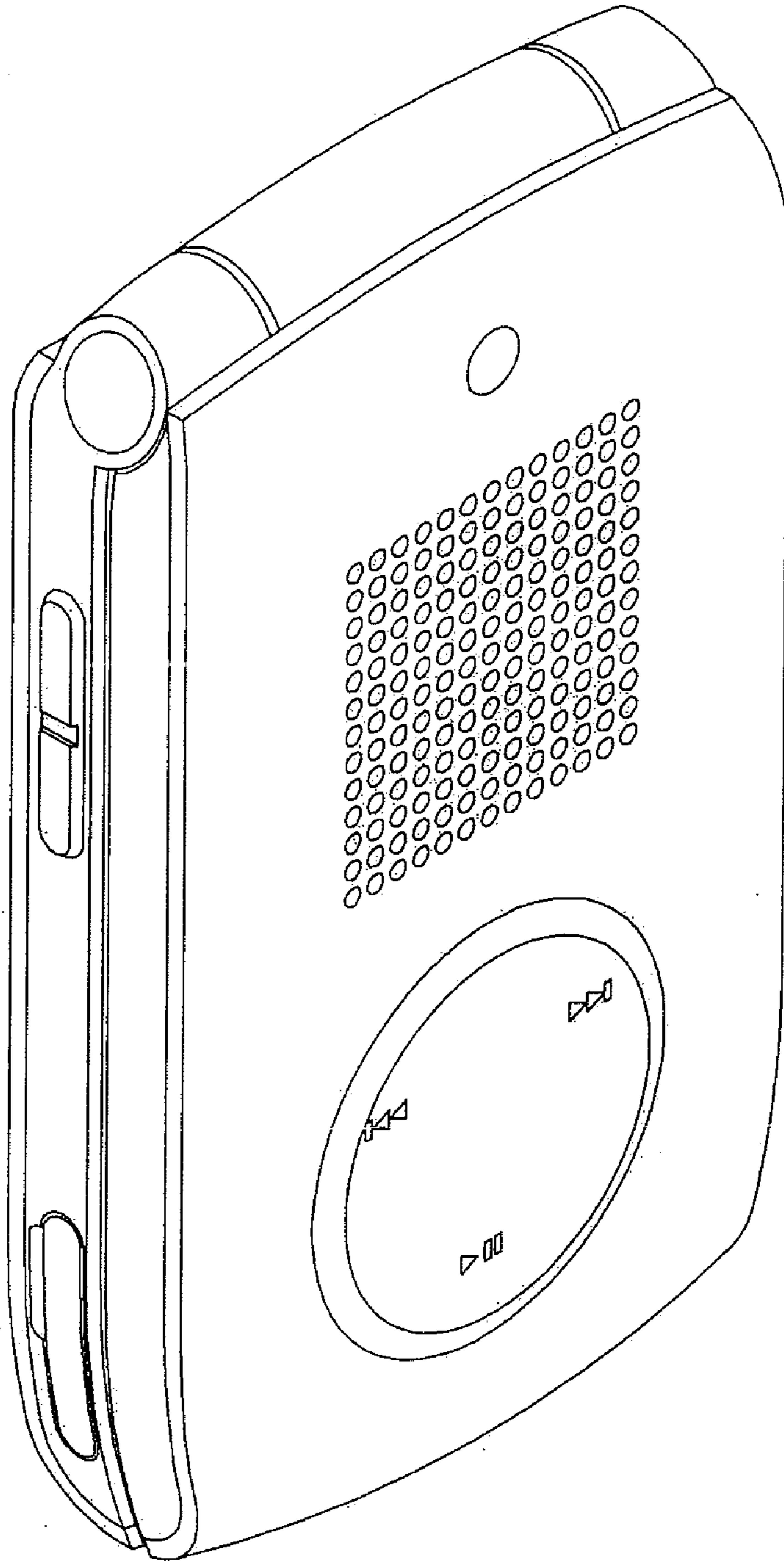

FIG. 2

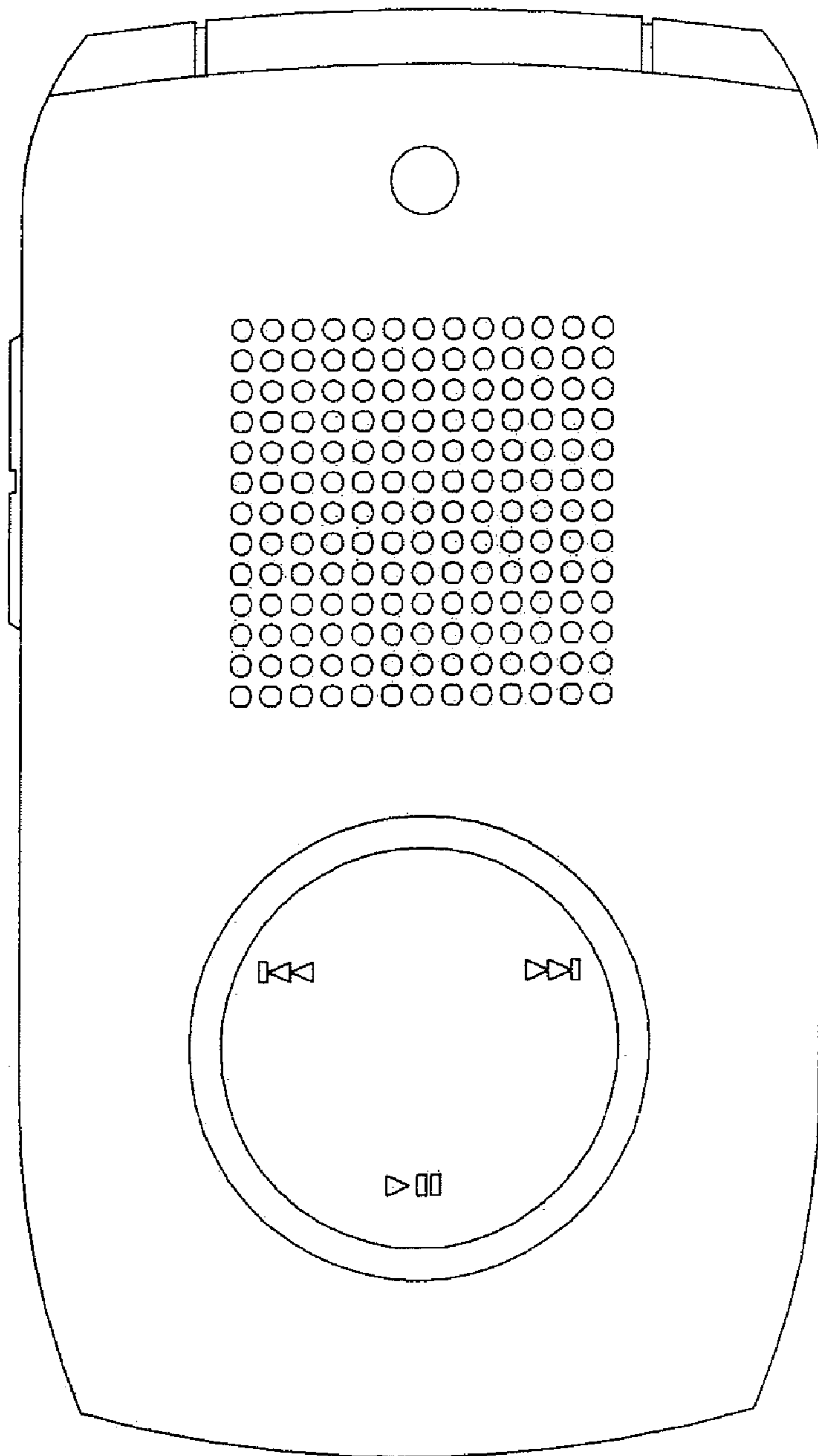

FIG. 3

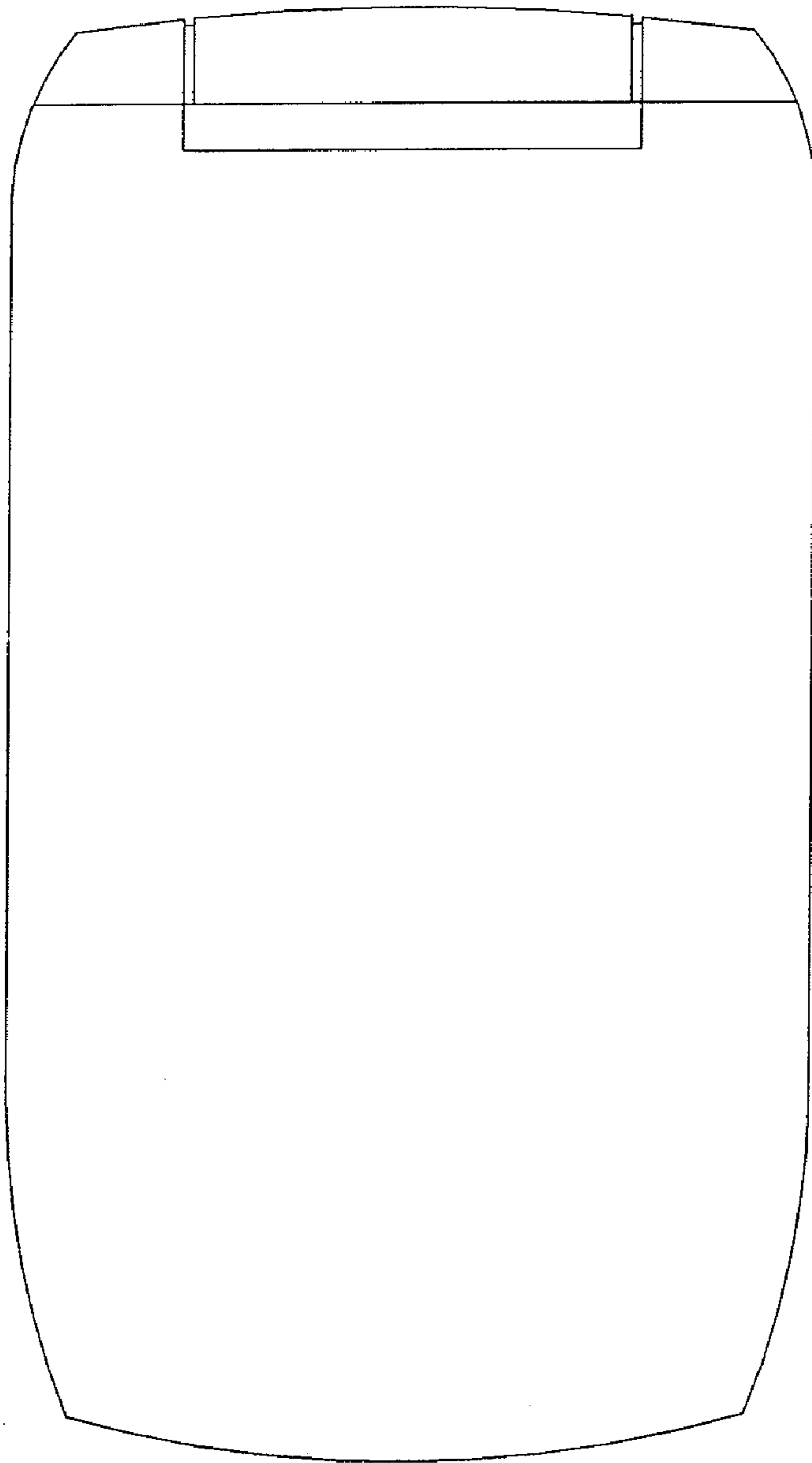

FIG. 4

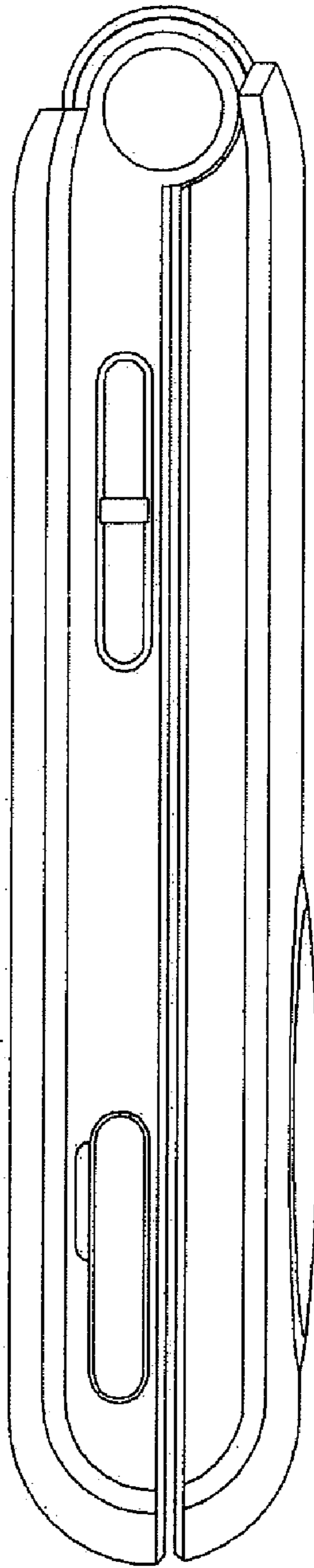

FIG. 5

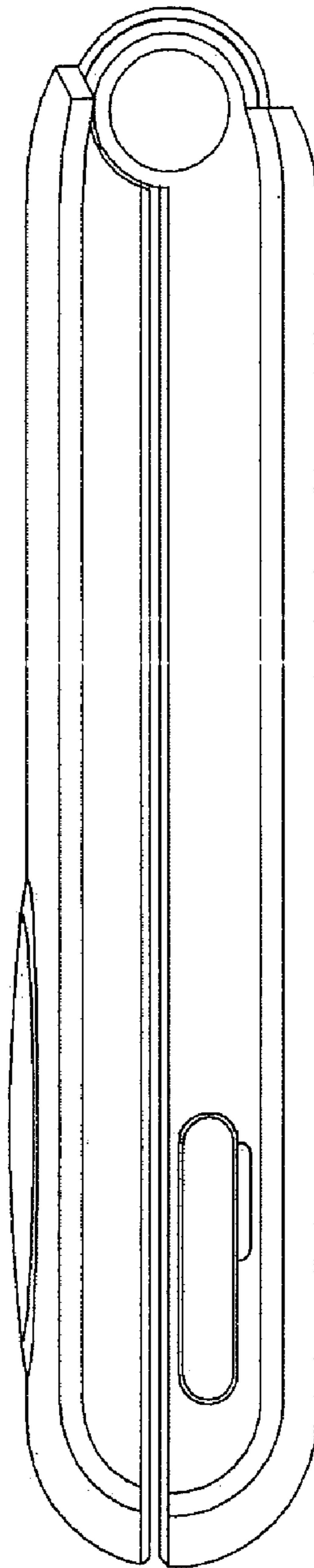

FIG. 6

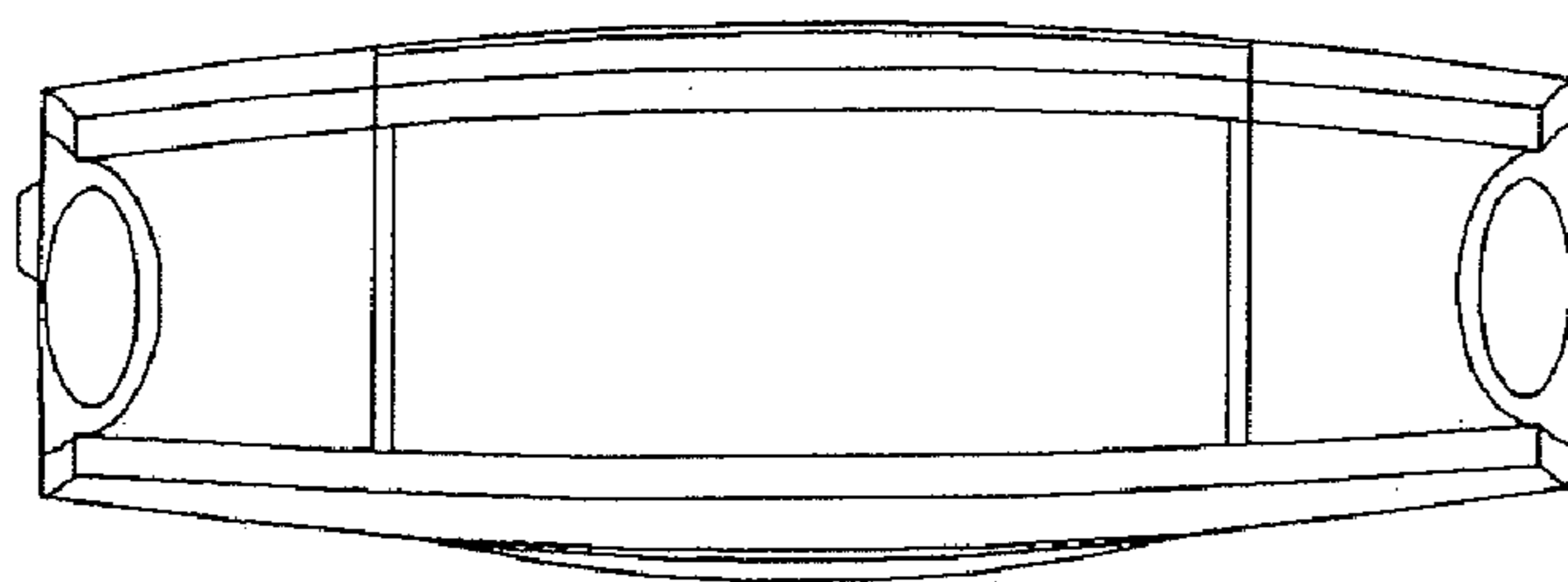

FIG. 7

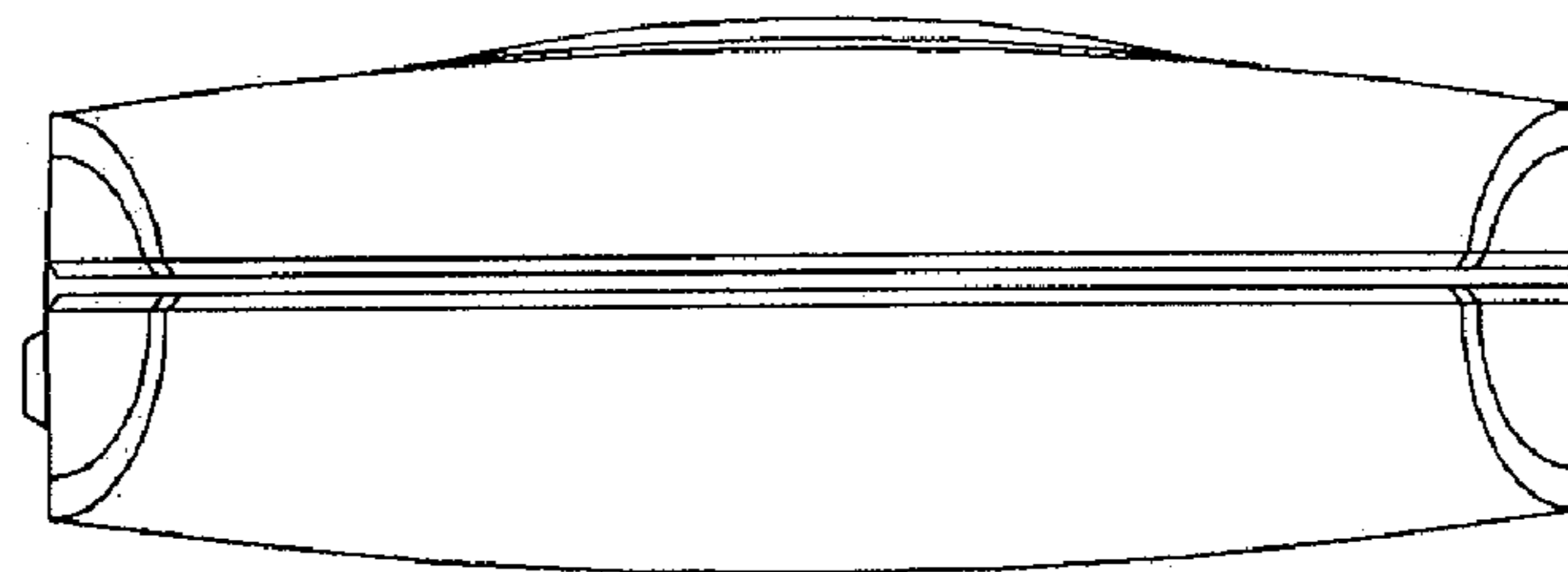

FIG. 8

