

US00D576595S

(12) **United States Design Patent**
Han et al.

(10) **Patent No.:** **US D576,595 S**
(45) **Date of Patent:** **** *Sep. 9, 2008**

(54) **PORTABLE TELEPHONE**

(75) Inventors: **Woo-Seung Han**, Seoul (KR); **Nam-Mi Kim**, Seoul (KR); **Chang-Hwan Hwang**, Seoul (KR)

(73) Assignee: **Samsung Electronics Co., Ltd.**,
Kyunggi-do (KR)

(*) Notice: This patent is subject to a terminal disclaimer.

(**) Term: **14 Years**

(21) Appl. No.: **29/288,721**

(22) Filed: **Jun. 21, 2007**

(51) **LOC (8) Cl.** **14-03**
(52) **U.S. Cl.** **D14/138**
(58) **Field of Classification Search** D14/138,
D14/496, 137, 147, 191, 218, 247-248, 341-347;
D13/168; D18/7; 455/575.4, 90.3, 556.1,
455/556.2, 575.1, 575.3; 379/433.01-433.13;
361/814; 348/14.02

See application file for complete search history.

(56) **References Cited**

U.S. PATENT DOCUMENTS

D337,569 S *	7/1993	Kando	D14/341
D466,096 S *	11/2002	Takada	D14/138
D503,164 S	3/2005	Park et al.		
D503,699 S	4/2005	Lee et al.		
D508,473 S *	8/2005	Lee et al.	D14/138
D509,202 S *	9/2005	Lee et al.	D14/138
D512,702 S	12/2005	Lee et al.		
D517,038 S	3/2006	Lee et al.		
D525,608 S *	7/2006	Ryu	D14/138
D526,303 S *	8/2006	Kim et al.	D14/138
D527,364 S *	8/2006	Lee et al.	D14/138
D529,472 S	10/2006	Kim et al.		
D529,473 S *	10/2006	Kim et al.	D14/138
D529,475 S *	10/2006	Lee et al.	D14/138
D529,891 S	10/2006	Hyun et al.		
D531,608 S	11/2006	Kim et al.		

D531,611 S	11/2006	Kim et al.
D531,612 S	11/2006	Kim et al.
D531,973 S	11/2006	Kim et al.
D533,530 S	12/2006	Kim et al.
D533,532 S	12/2006	Kim et al.

(Continued)

OTHER PUBLICATIONS

InnoStream INNO P10, announced Jun. 2005, [online], [retrieved on Feb. 20, 2007]. Retrieved from Internet ,<URL: http://www.gsmarena.com>.*

(Continued)

Primary Examiner—Jeffrey D. Asch
Assistant Examiner—Bridget L Eland
(74) *Attorney, Agent, or Firm*—Flynn, Thiel, Boutell & Tanis, P.C.

(57) **CLAIM**

The ornamental design for a portable telephone, as shown and described.

DESCRIPTION

FIG. 1 is a left side front perspective view of a portable telephone showing our new design;
FIG. 2 is a front elevational view thereof;
FIG. 3 is a rear elevational view thereof;
FIG. 4 is a left side elevational view thereof;
FIG. 5 is a right side elevational view thereof;
FIG. 6 is a top plan view thereof; and,
FIG. 7 is a bottom plan view thereof.

1 Claim, 5 Drawing Sheets

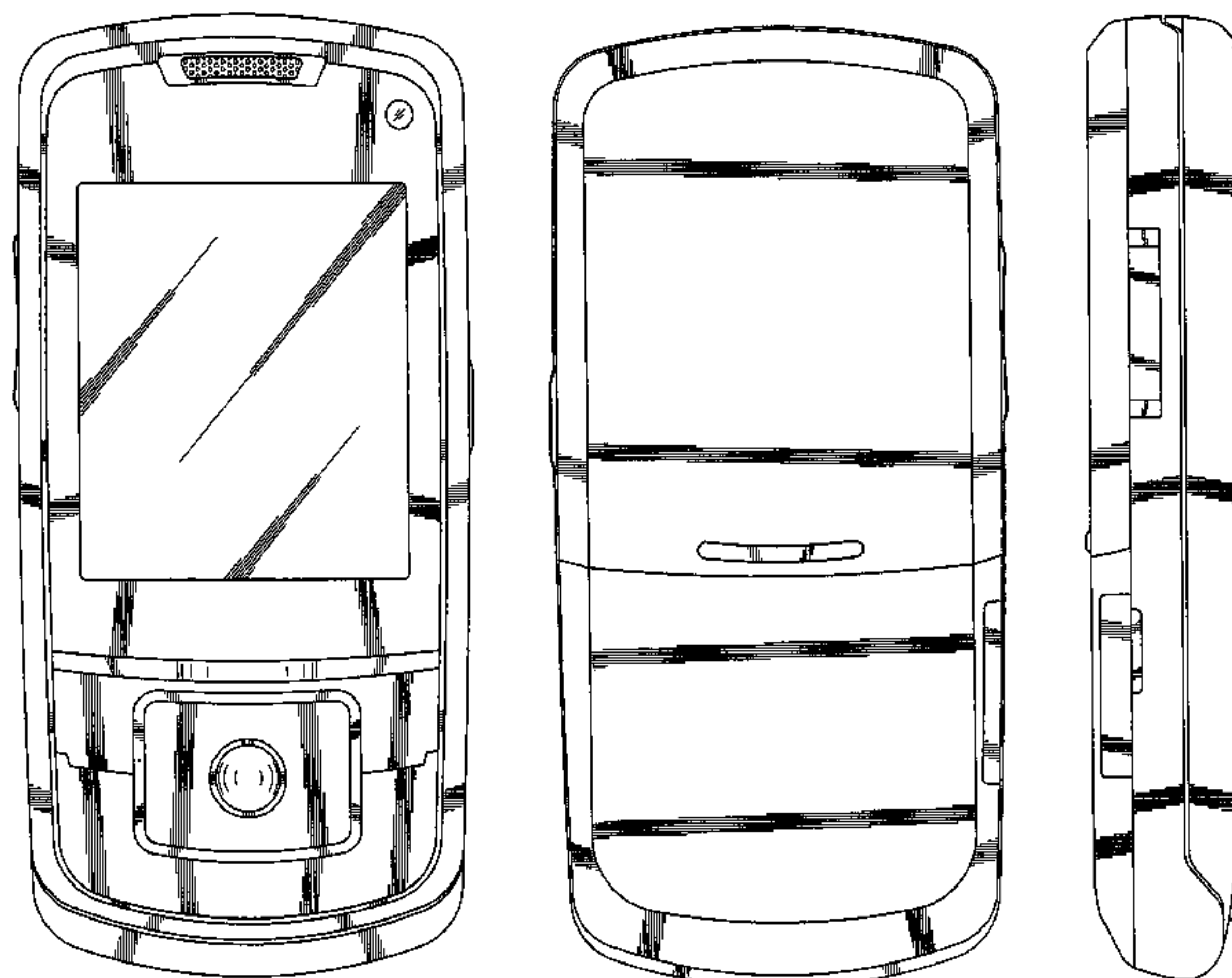

U.S. PATENT DOCUMENTS

D534,144	S	12/2006	Chung et al.	
D534,892	S	1/2007	Lee et al.	
D535,275	S *	1/2007	Kim et al.	D14/138
D535,959	S	1/2007	Cho et al.	
D535,968	S *	1/2007	Lee	D14/138
D543,176	S *	5/2007	Hyun et al.	D14/138
D545,292	S *	6/2007	Lee et al.	D14/138
D548,715	S *	8/2007	Lee et al.	D14/138
D549,202	S *	8/2007	Kim et al.	D14/138
D551,201	S *	9/2007	Kim et al.	D14/138
D551,646	S *	9/2007	Kim et al.	D14/138
D552,057	S *	10/2007	Kim	D14/138
D552,580	S *	10/2007	Mun	D14/138
D555,128	S *	11/2007	Jen et al.	D14/138
D555,620	S *	11/2007	Lee et al.	D14/138
D555,623	S *	11/2007	Cho et al.	D14/138
2005/0124381	A1 *	6/2005	Kim et al.	455/556.1
2006/0046796	A1 *	3/2006	Park et al.	455/575.4
2007/0021160	A1 *	1/2007	Li	455/575.4
2007/0232370	A1 *	10/2007	Kim	455/575.4

OTHER PUBLICATIONS

O2 X7, announced Sep. 2005, [online], [retrieved on Dec. 13, 2007]. Retrieved from Internet ,<URL: <http://www.gsmarena.com>>.*
 Philips Xenium 9@9m, announced May 2007, [online], [retrieved on May 18, 2007]. Retrieved from Internet ,<URL: <http://www.gsmarena.com>>.*
 Bird D636, announced May 2007, [online], [retrieved on May 19, 2007]. Retrieved from Internet ,<URL: <http://www.gsmarena.com>>.*
 U.S. Appl. No. 29/273,486, Applicant: Chang-Hoon Suk, et al. filed Mar. 6, 2007 entitled Portable Telephone.

U.S. Appl. No. 29/273,487, Applicant: Chang-Hoon Suk, et al. filed Mar. 6, 2007 entitled Portable Telephone.
 U.S. Appl. No. 29/273,485, Applicant: Jong-Yun Jeoung, et al. filed Mar. 6, 2007 entitled Portable Telephone.
 U.S. Appl. No. 29/288,718, Applicant: Woo-Seung Han, et al. filed Jun. 21, 2007 entitled Portable Telephone.
 U.S. Appl. No. 29/288,722, Applicant: Woo-Seung Han, et al. filed Jun. 21, 2007 entitled Portable Telephone.
 Samsung D520 telephone, announced 2006, Feb. [online], [retrieved on Jul. 24, 2007]. Retrieved from Internet, URL:<http://www.gsmarena.com>.
 Samsung D720 telephone, announced 2005, 1st quarter [online], [retrieved on Feb. 8, 2007], Retrieved from Internet, URL:<http://www.gsmarena.com>.
 Samsung E390 telephone, announced 2006. Oct. [online], [retrieved on Jul. 25, 2007]. Retrieved from Internet, URL:<http://www.gsmarena.com>.
 Samsung E800 telephone, announced 2004, Mar. [online], [retrieved on Jul. 24, 2007]. Retrieved from Internet, URL:<http://www.gsmarena.com>.
 Samsung E860 telephone, announced 2005, 4th quarter, [retrieved on Jul. 24, 2007]. Retrieved from Internet, URL:<http://www.gsmarena.com>.
 Nokia 6111 telephone, announced 2005, Jun. [online], [retrieved on Feb. 16, 2007]. Retrieved from Internet, URL:<http://www.gsmarena.com>.
 Nokia 6270 telephone, announced 2005, Jun. [online], [retrieved on Feb. 16, 2007]. Retrieved from Internet, URL:<http://www.gsmarena.com>.
 Nolia 6288 telephone, announced 2006, Sep. [online], [retrieved on Feb. 16, 2007]. Retrieved from Internet, URL:<http://www.gsmarena.com>.

* cited by examiner

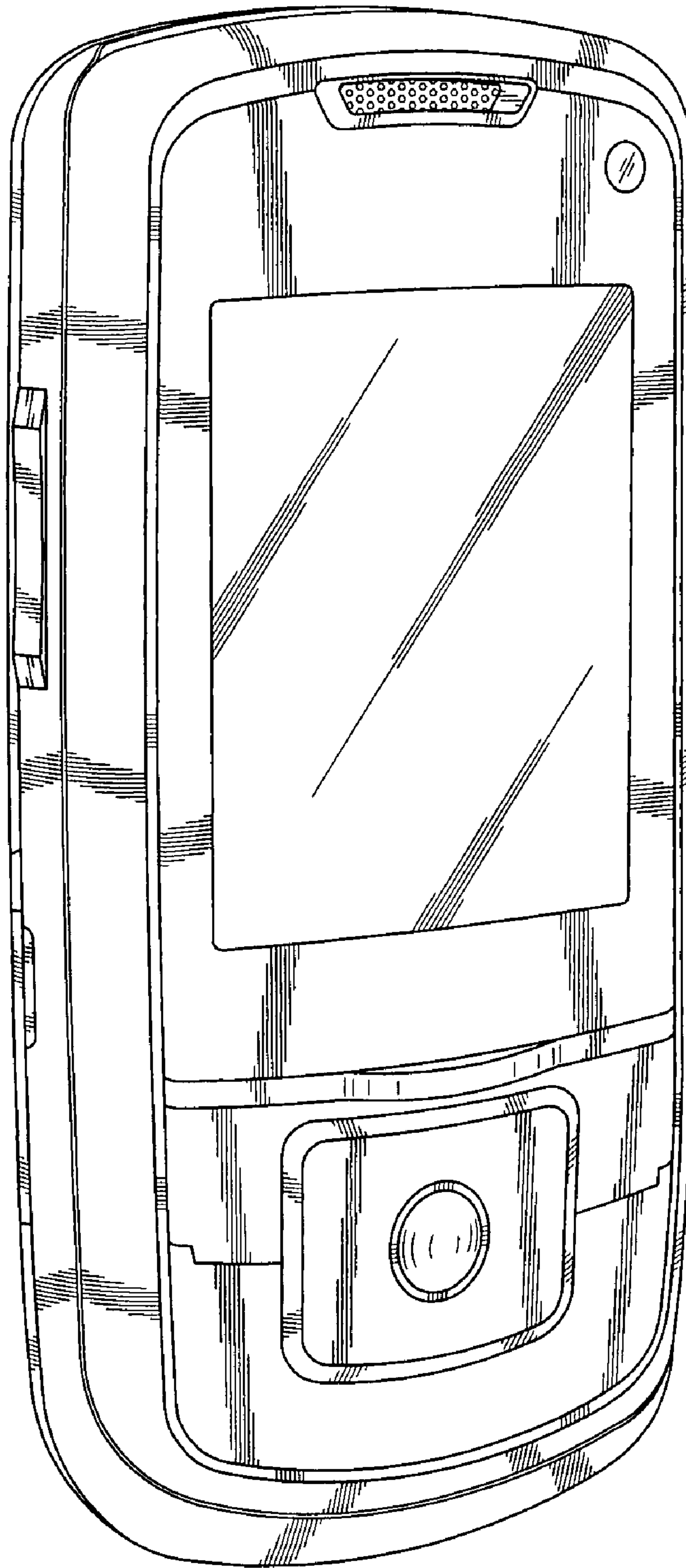

FIG. 1

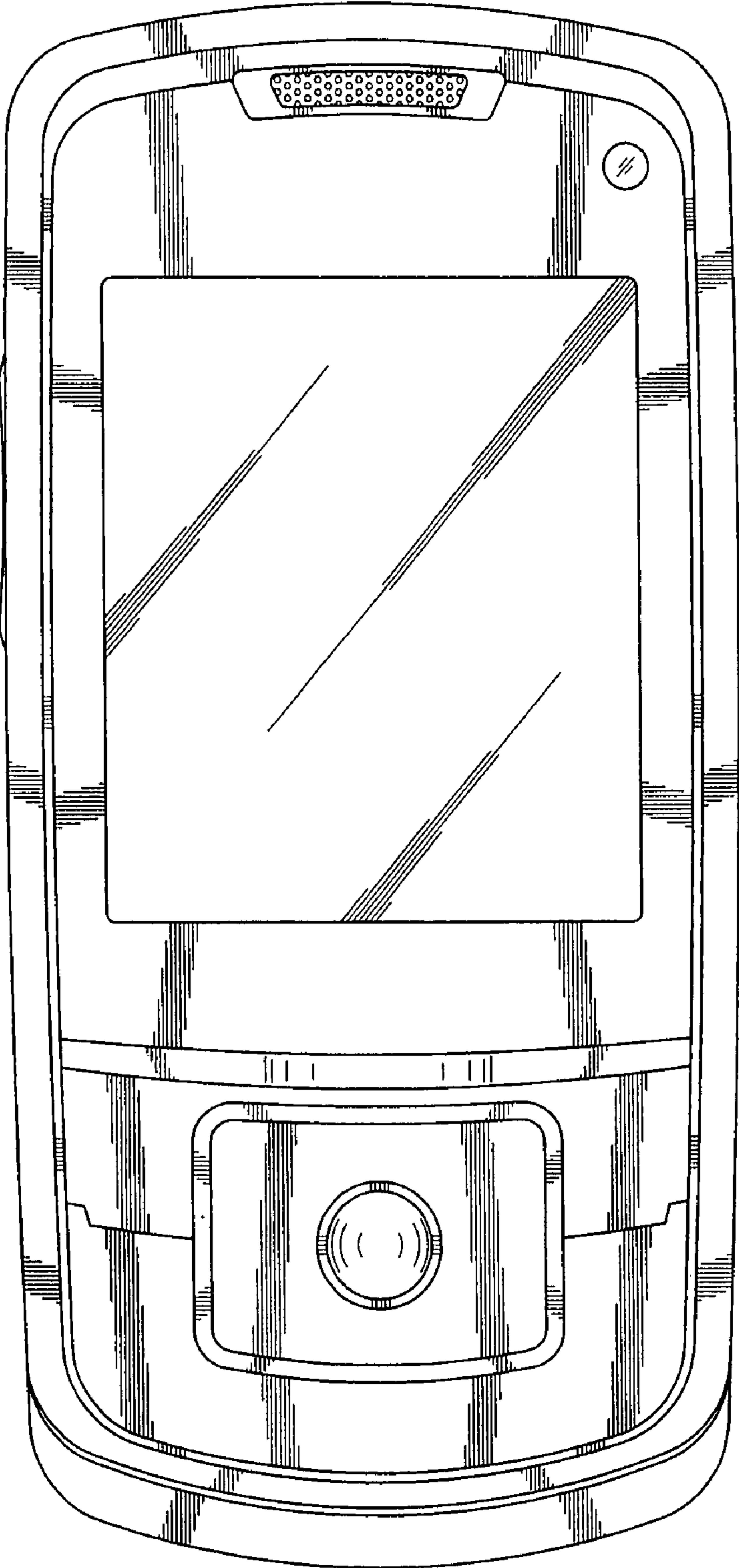

FIG. 2

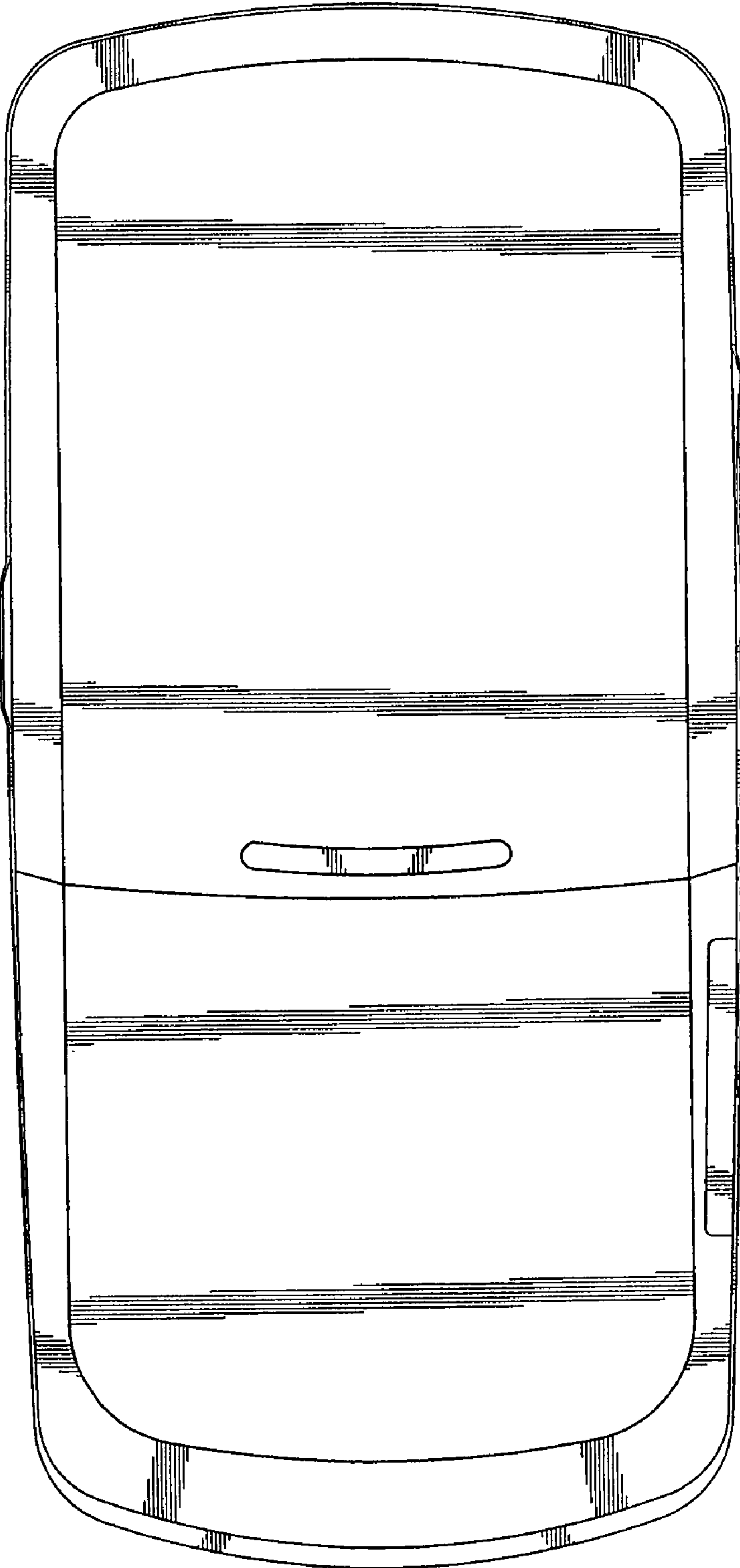

FIG. 3

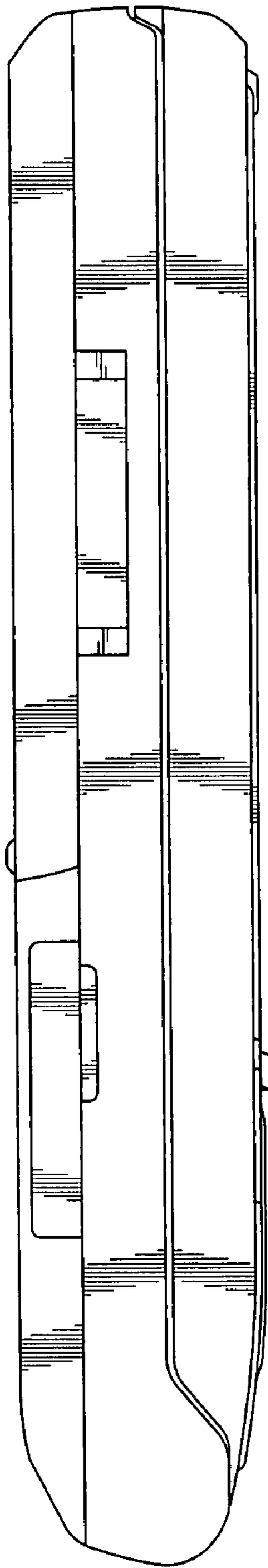

FIG. 4

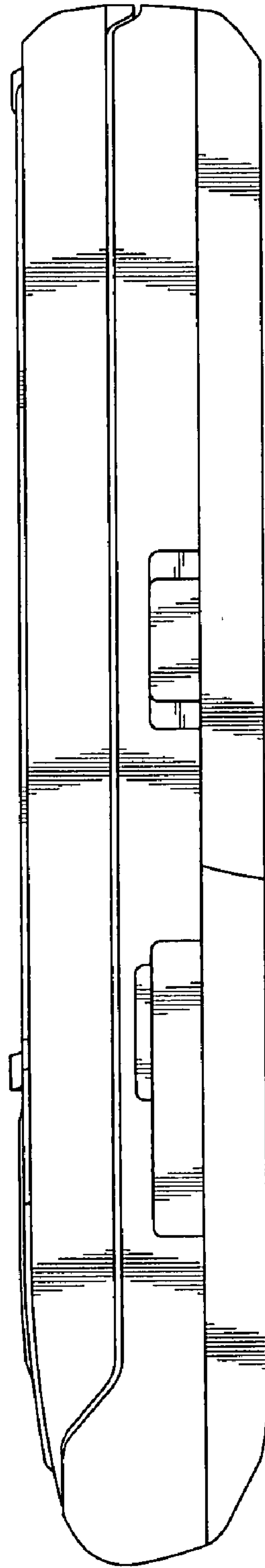

FIG. 5

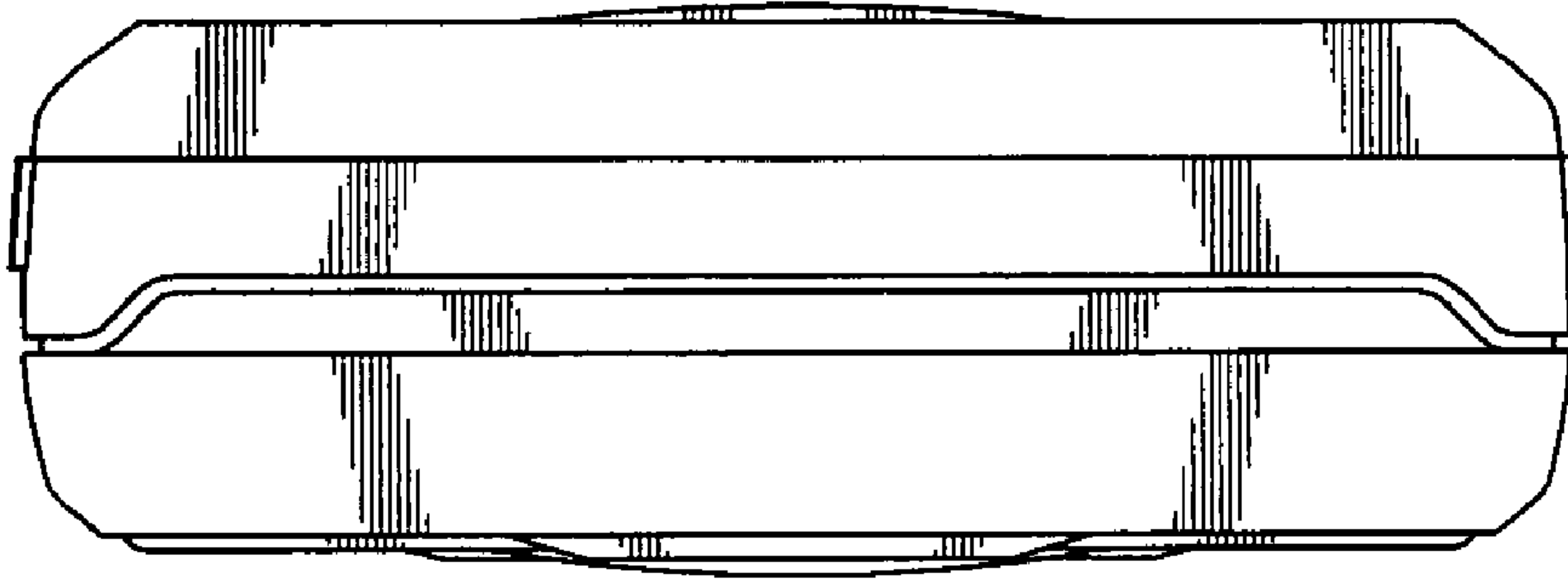

FIG. 6

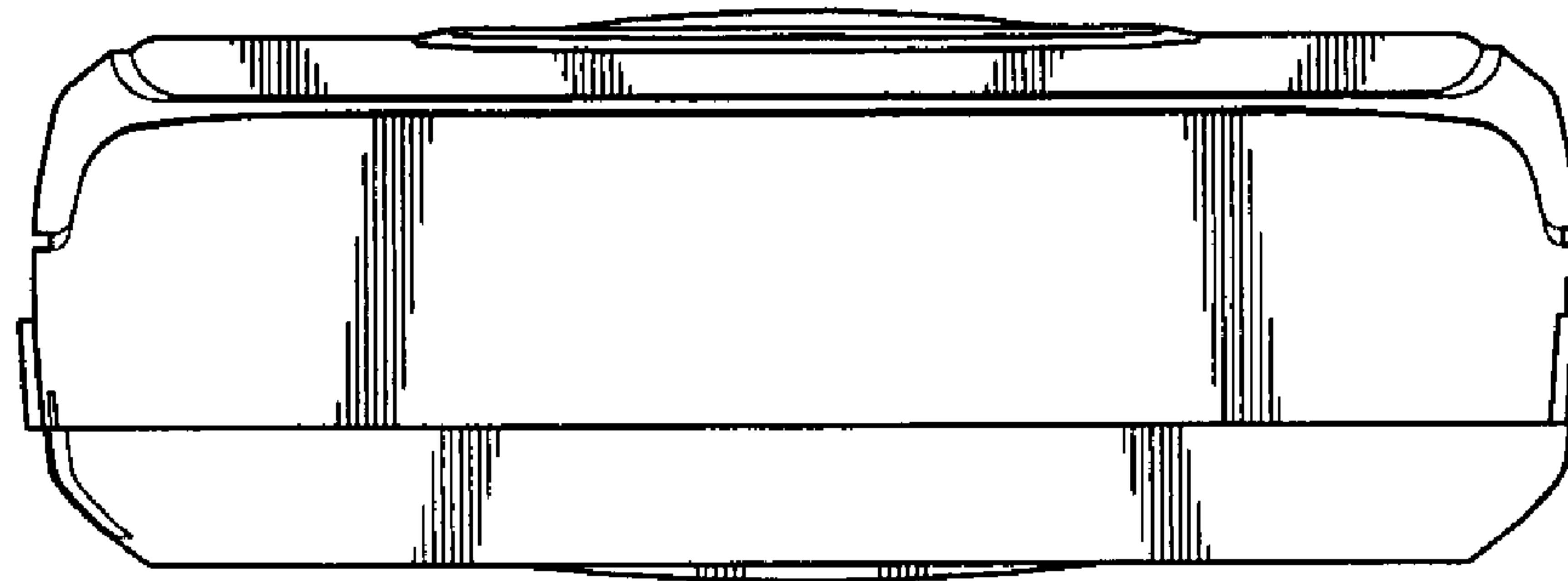

FIG. 7