



US00D576578S

(12) **United States Design Patent**  
**Calverley**

(10) **Patent No.:** **US D576,578 S**

(45) **Date of Patent:** **\*\* Sep. 9, 2008**

(54) **VISUAL DISPLAY UNIT**

(75) Inventor: **Simon Calverley**, Hampshire (GB)

(73) Assignee: **De la Rue International Limited**,  
Basingstoke (GB)

(\*\*) Term: **14 Years**

(21) Appl. No.: **29/287,956**

(22) Filed: **Oct. 4, 2007**

(30) **Foreign Application Priority Data**

Apr. 4, 2007 (EM) ..... 000704440-0001/0002

(51) **LOC (8) Cl.** ..... **14-03**

(52) **U.S. Cl.** ..... **D14/126**

(58) **Field of Classification Search** ..... D14/125-134,  
D14/239, 371, 136, 374-377, 440, 450, 448,  
D14/336, 342; 312/7.2; 348/836, 838, 180,  
348/184, 325, 739; 341/12; 248/917-924,  
248/465; 345/104, 133, 156, 168, 87, 173;  
720/605, 669, 600, 655; 369/99, 197; 455/344,  
455/347; D21/329, 515, 577, 622, 333, 433,  
D21/448, 452, 450, 331; D6/477, 479; 273/148 B;  
446/484, 175, 356; D10/15, 26  
See application file for complete search history.

(56) **References Cited**

**U.S. PATENT DOCUMENTS**

D398,293 S \* 9/1998 Lindblom ..... D14/381

D460,448 S \* 7/2002 Matsumoto ..... D14/346  
D525,605 S \* 7/2006 Voege ..... D14/126  
D535,631 S \* 1/2007 Millora ..... D14/126  
D536,360 S \* 2/2007 Dayan ..... D16/242  
D541,239 S \* 4/2007 Tsai ..... D14/126  
D566,071 S \* 4/2008 Kaneko ..... D14/126

\* cited by examiner

*Primary Examiner*—Raphael Barkai

(74) *Attorney, Agent, or Firm*—Oliff & Berridge, PLC

(57) **CLAIM**

The ornamental design for a visual display unit, as shown and described.

**DESCRIPTION**

FIG. 1 is a perspective view of a visual display unit;

FIG. 2 is a front view thereof;

FIG. 3 is a top view thereof;

FIG. 4 is a left-side view thereof;

FIG. 5 is a right-side view thereof;

FIG. 6 is a bottom view thereof; and,

FIG. 7 is a rear view thereof.

The broken lines depict environmental subject matter only and form no part of the claimed design.

**1 Claim, 4 Drawing Sheets**

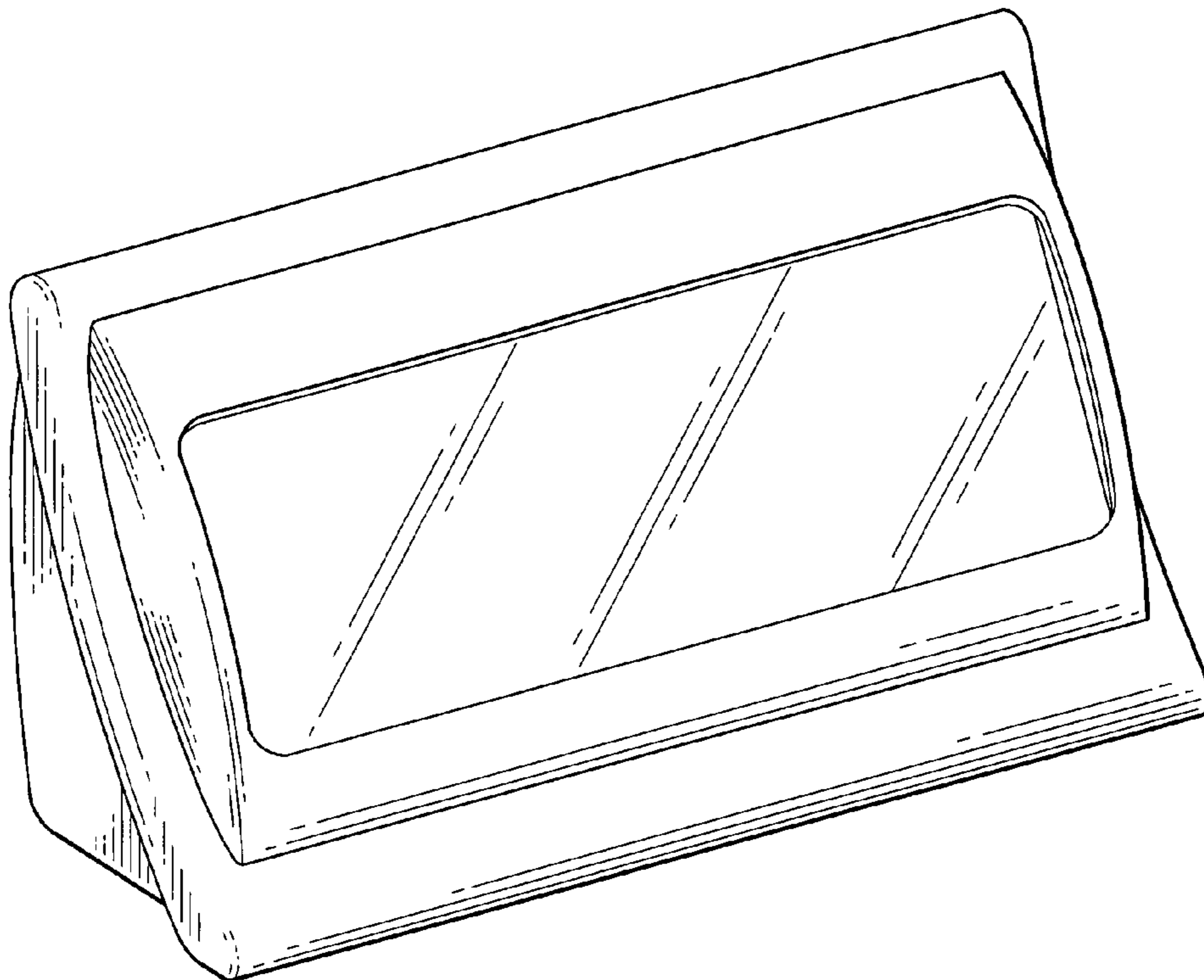

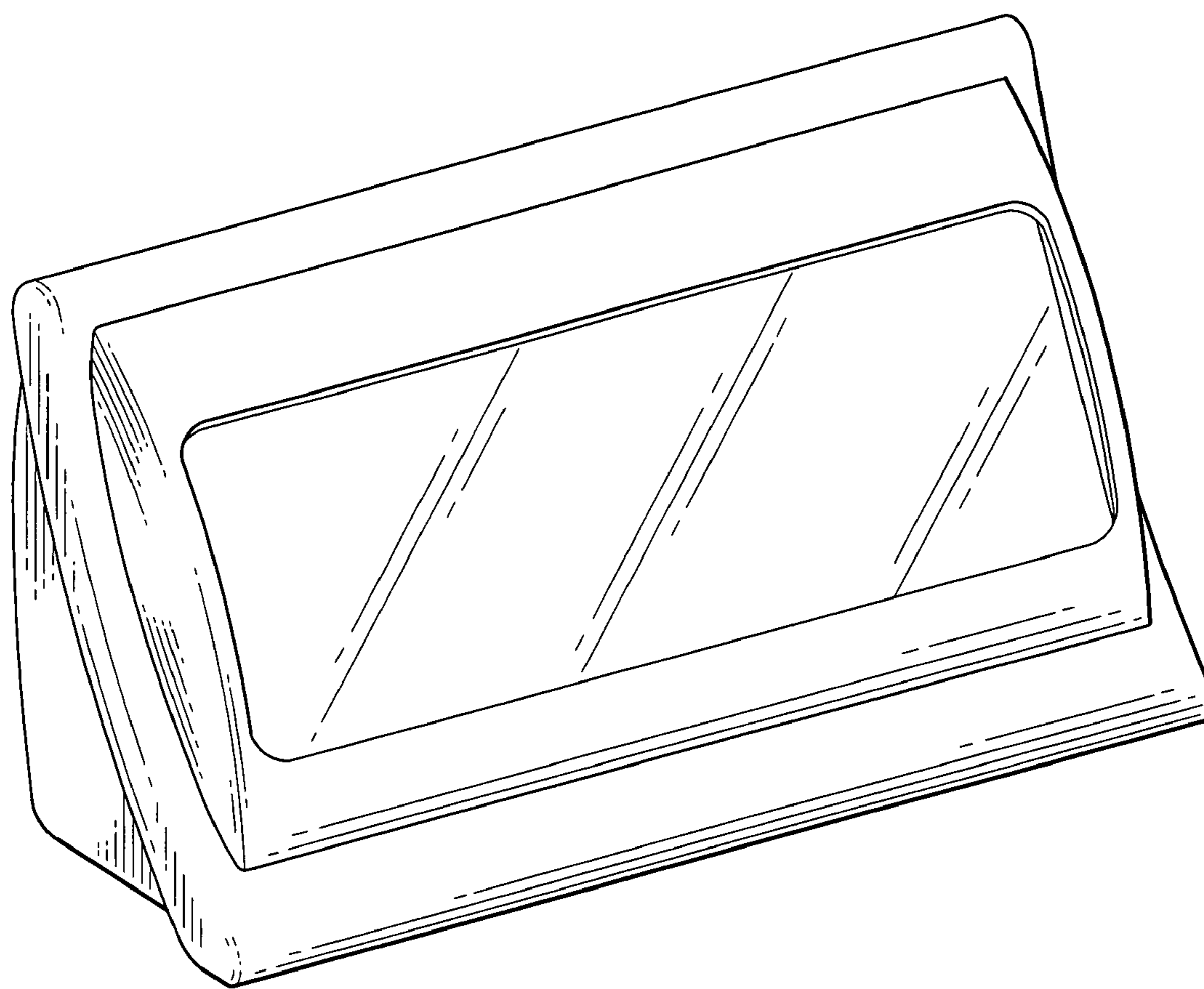

FIG. 1

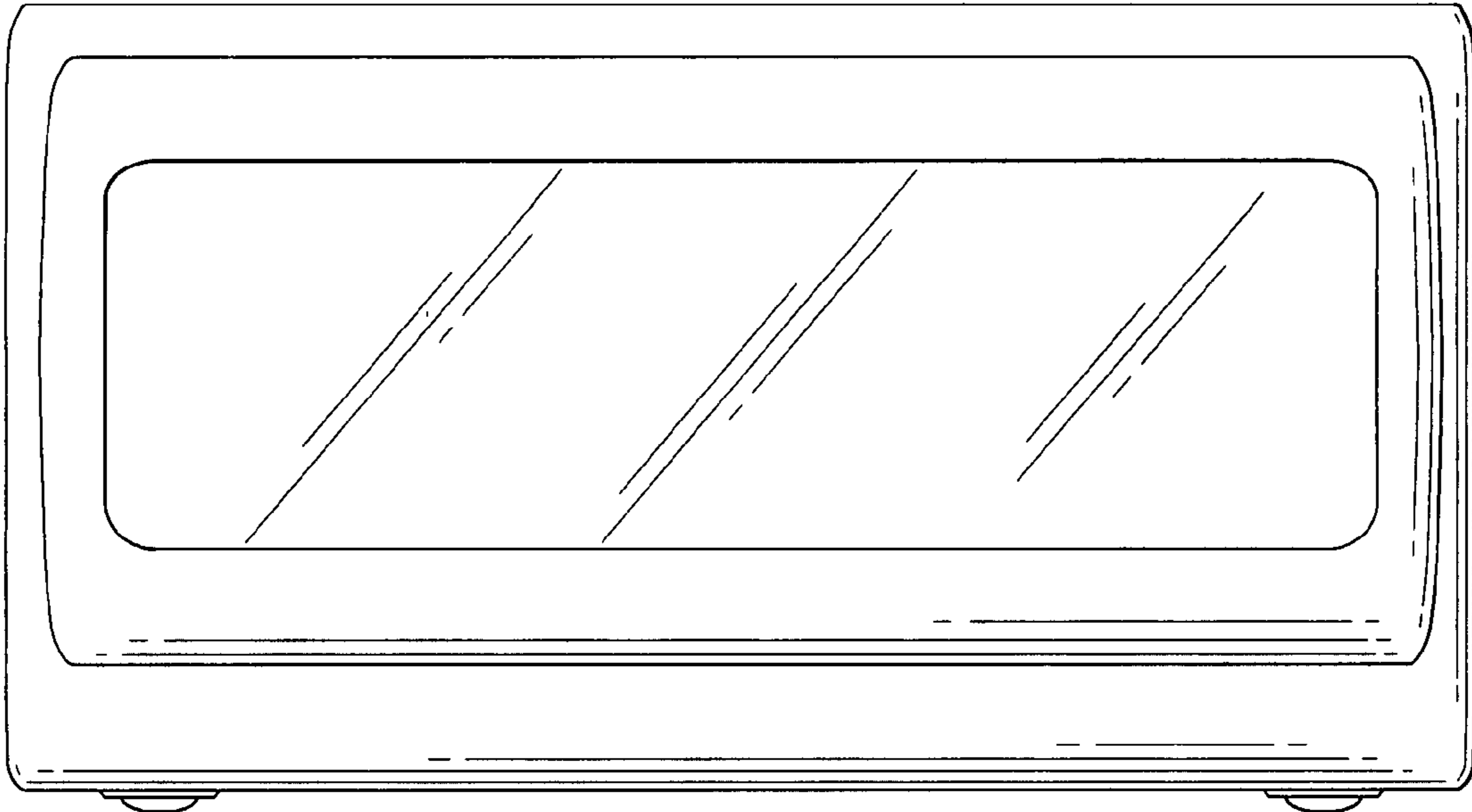

FIG. 2

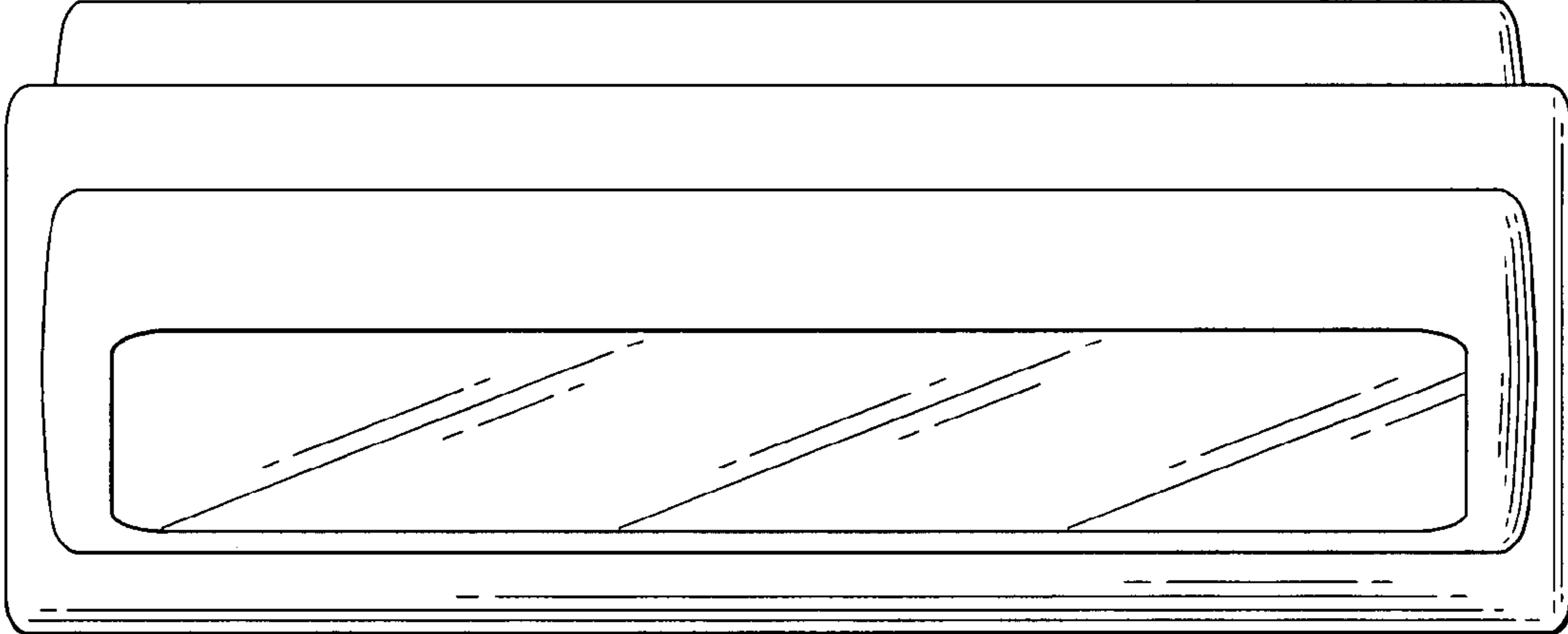

FIG. 3

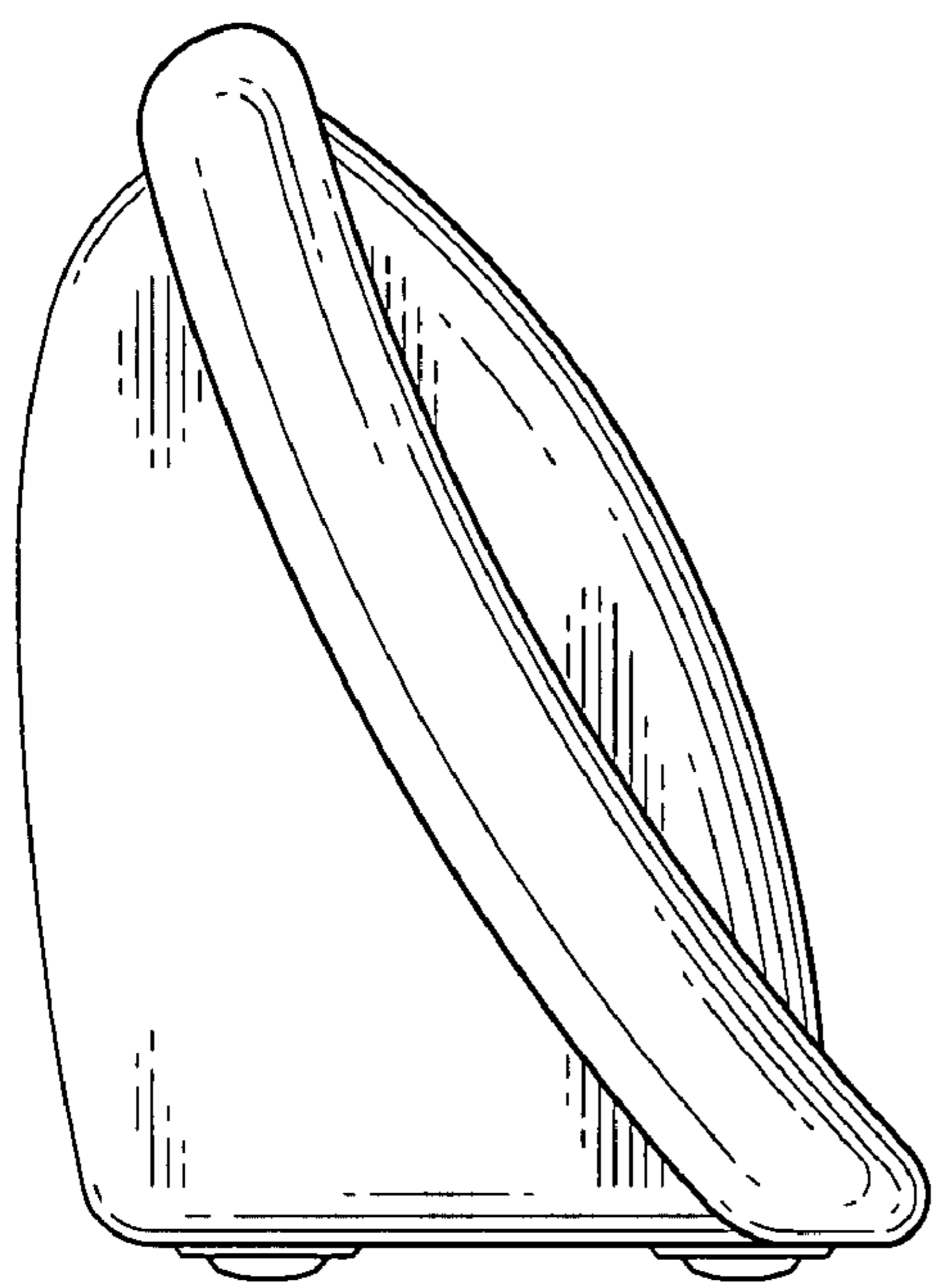

FIG. 4

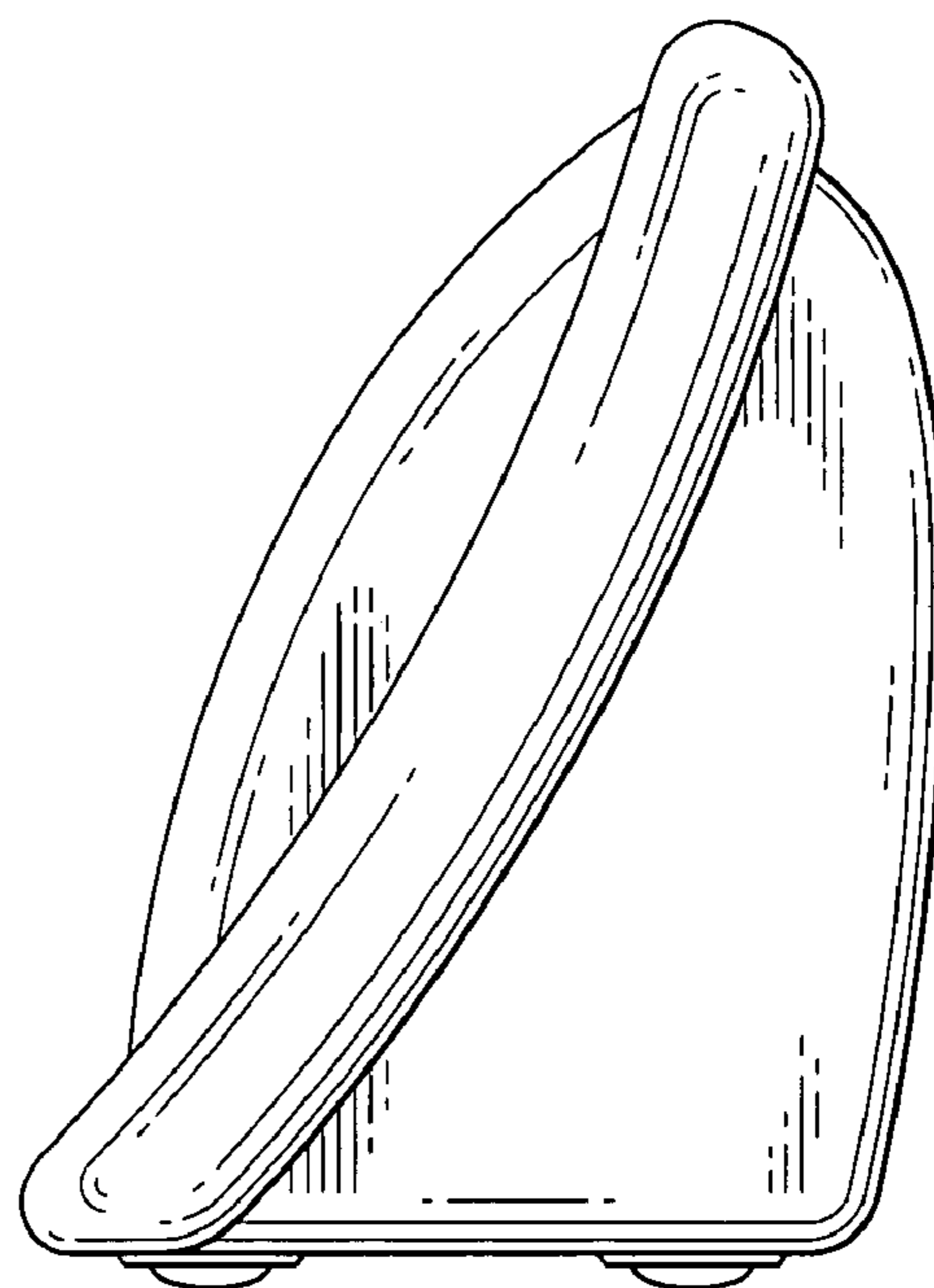

FIG. 5

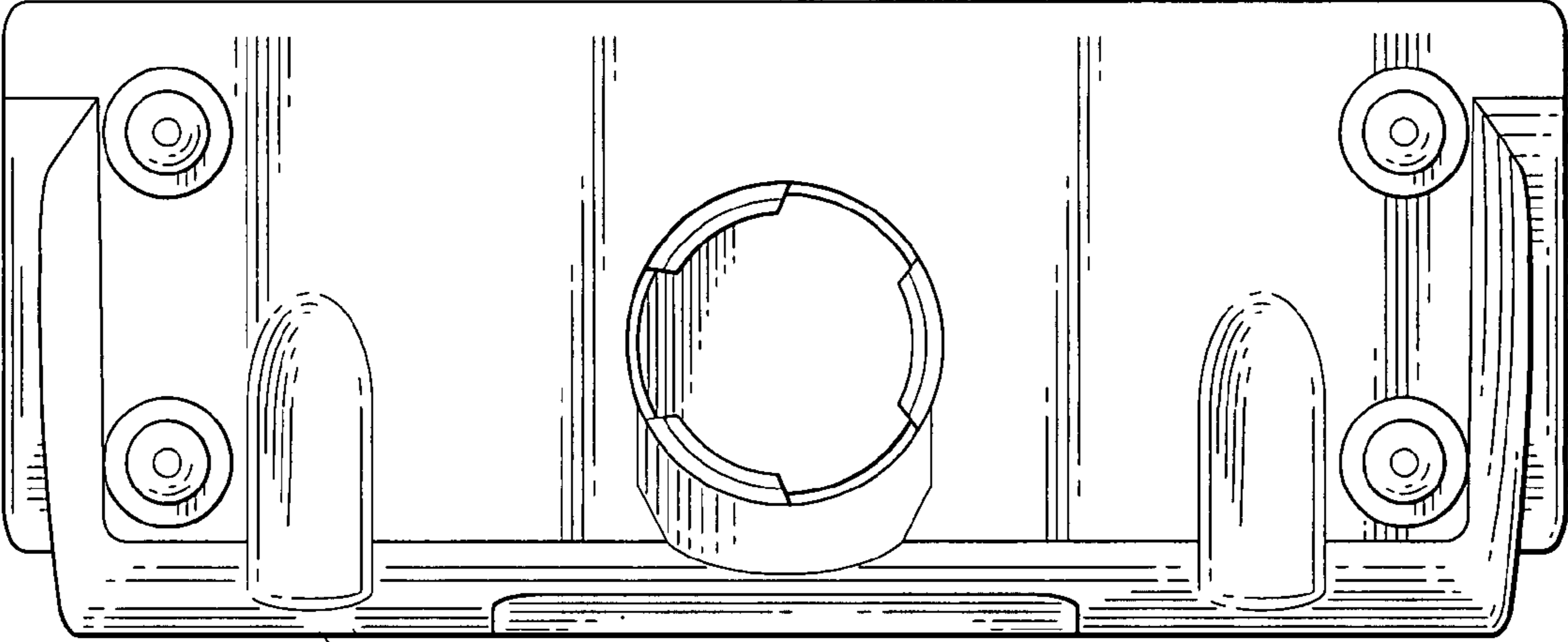

FIG. 6

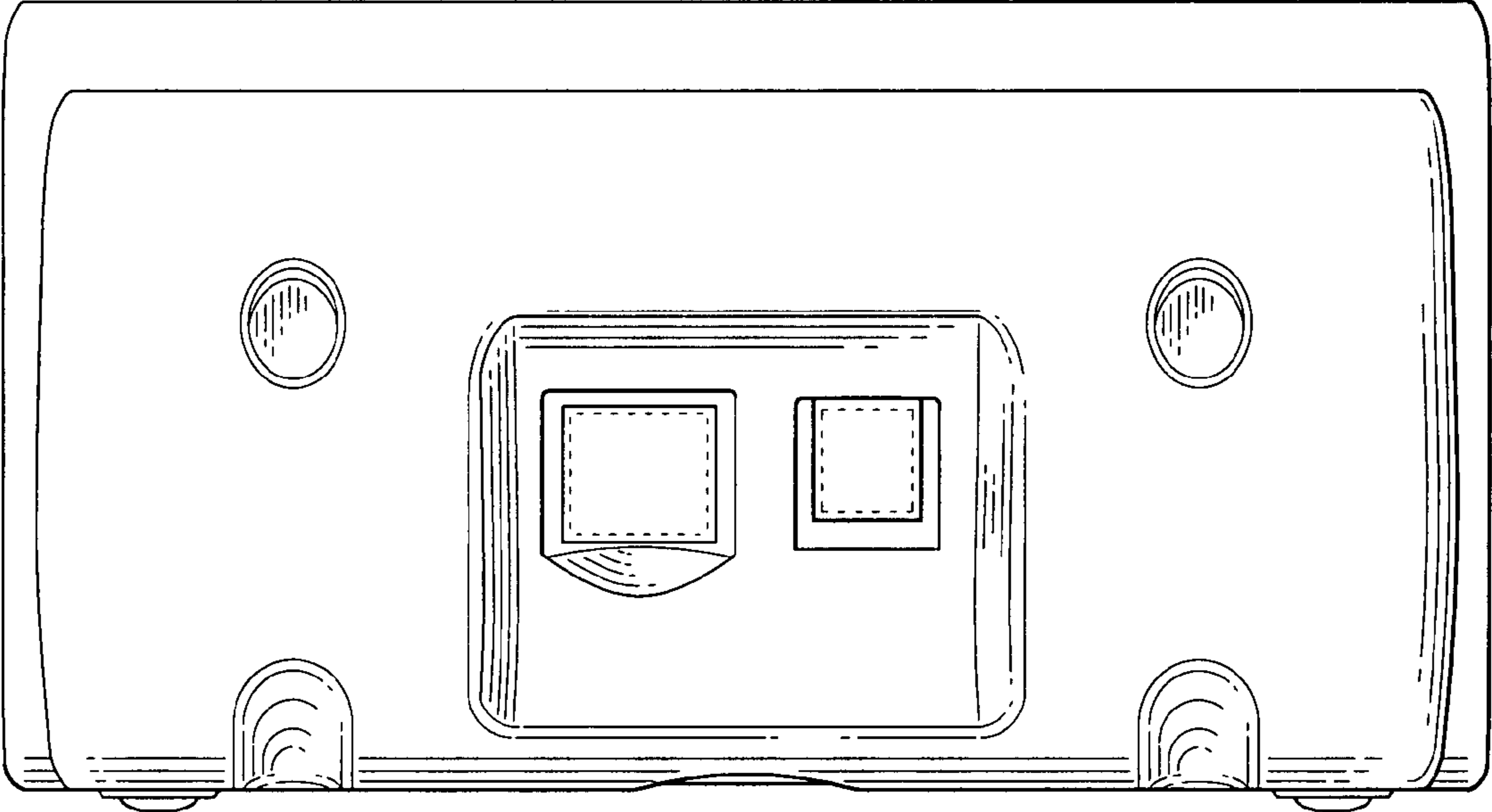

FIG. 7