



US00D576526S

(12) **United States Design Patent**
McBain

(10) **Patent No.:** **US D576,526 S**

(45) **Date of Patent:** **** Sep. 9, 2008**

(54) **BUMPER GUARD HITCH ASSEMBLY**

D553,057 S * 10/2007 Quernemoen D12/162

(76) Inventor: **Philip I. McBain**, 192 Mason Rd., West
Townsend, MA (US) 01474

* cited by examiner

Primary Examiner—Louis S Zarfaz

Assistant Examiner—Michael A Pratt

(**) Term: **14 Years**

(21) Appl. No.: **29/303,897**

(57) **CLAIM**

(22) Filed: **Feb. 20, 2008**

I claim, the ornamental design for the bumper guard hitch assembly, as shown and described.

(51) **LOC (8) Cl.** **12-16**

(52) **U.S. Cl.** **D12/162**

(58) **Field of Classification Search** D12/106,
D12/162, 400, 401, 403; 280/495, 507, 511,
280/727, 769; 40/200, 204, 205, 209, 211,
40/575, 590, 591; D26/28, 31, 34, 36; 224/527,
224/522, 524

See application file for complete search history.

DESCRIPTION

FIG. 1 is a front elevational view of the bumper guard hitch assembly showing my new design;

FIG. 2 is a rear elevational view of the bumper guard hitch assembly thereof;

FIG. 3 is a left-side elevational view of the bumper guard hitch assembly thereof;

FIG. 4 is a top plan view of the bumper guard hitch assembly thereof;

FIG. 5 is a bottom plan view of the bumper guard hitch assembly thereof; and,

FIG. 6 is a perspective view of the bumper guard hitch assembly thereof.

(56) **References Cited**

U.S. PATENT DOCUMENTS

D243,166	S	*	1/1977	Jones	D12/114
4,226,438	A	*	10/1980	Collins	280/507
D368,059	S	*	3/1996	Barth	D12/162
D518,421	S	*	4/2006	Blankenship, Jr.	D12/162
D528,949	S	*	9/2006	Tirey	D12/162
D549,623	S	*	8/2007	Gaddy	D12/162

1 Claim, 4 Drawing Sheets

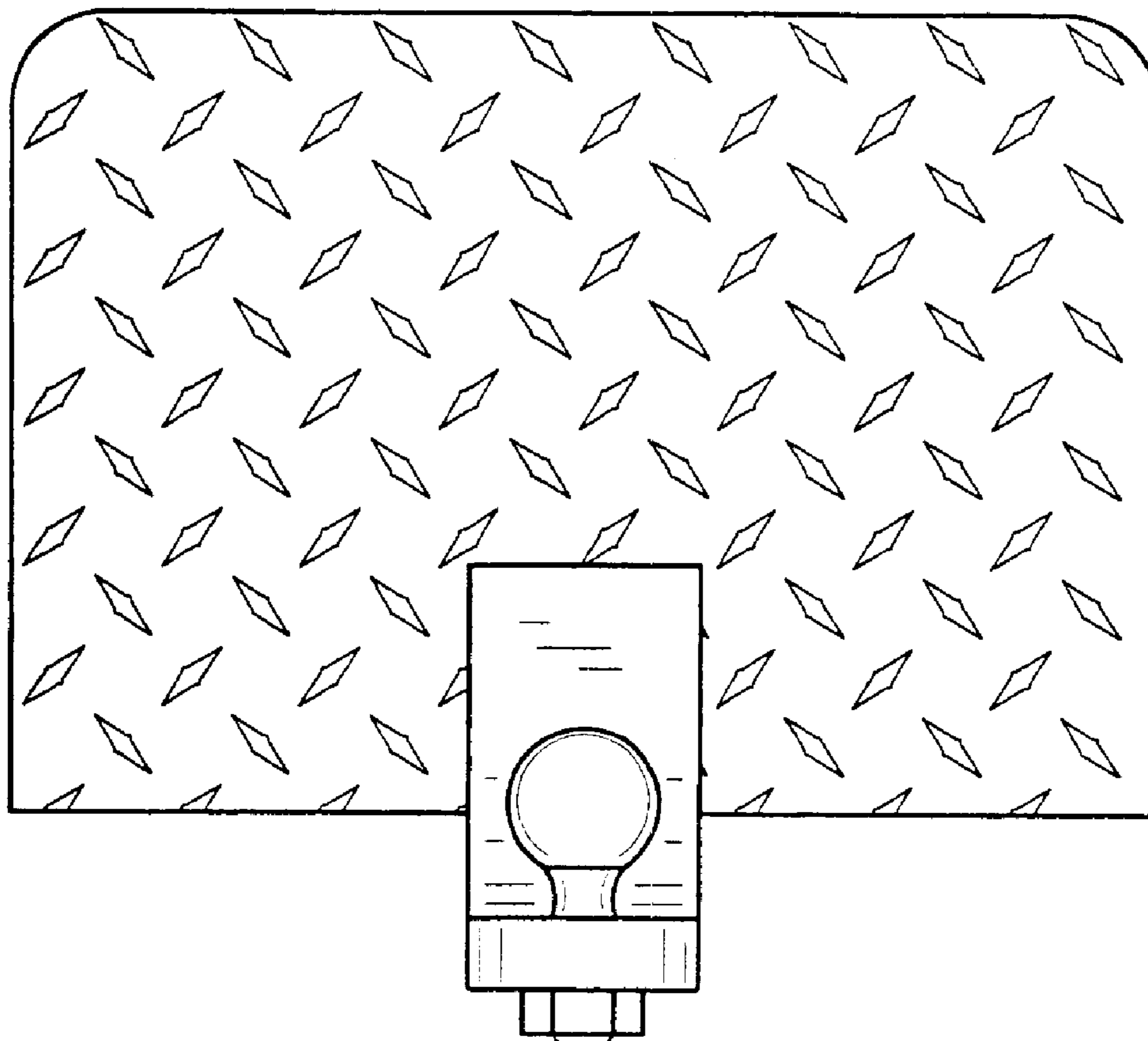

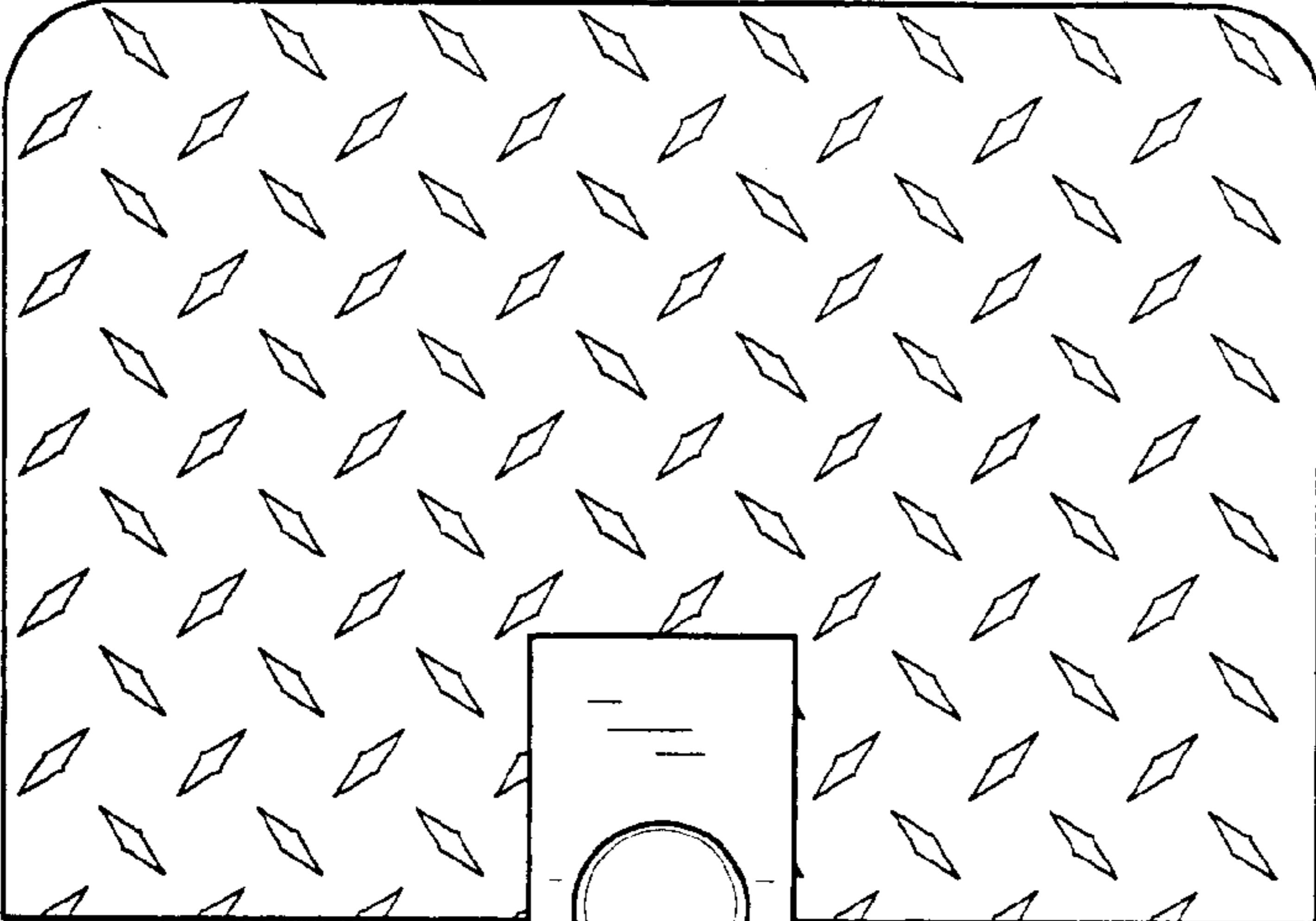

FIG. 1

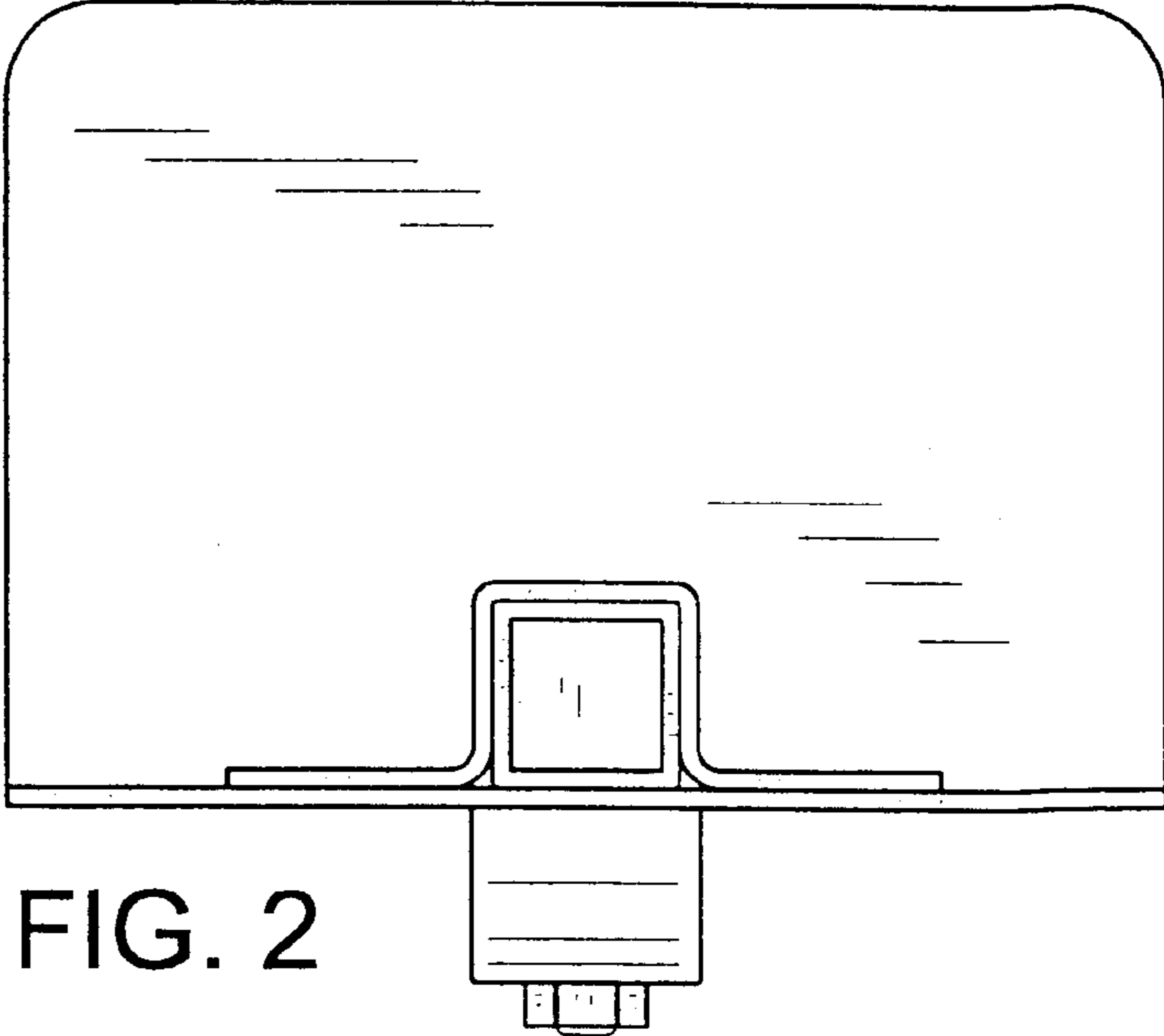

FIG. 2

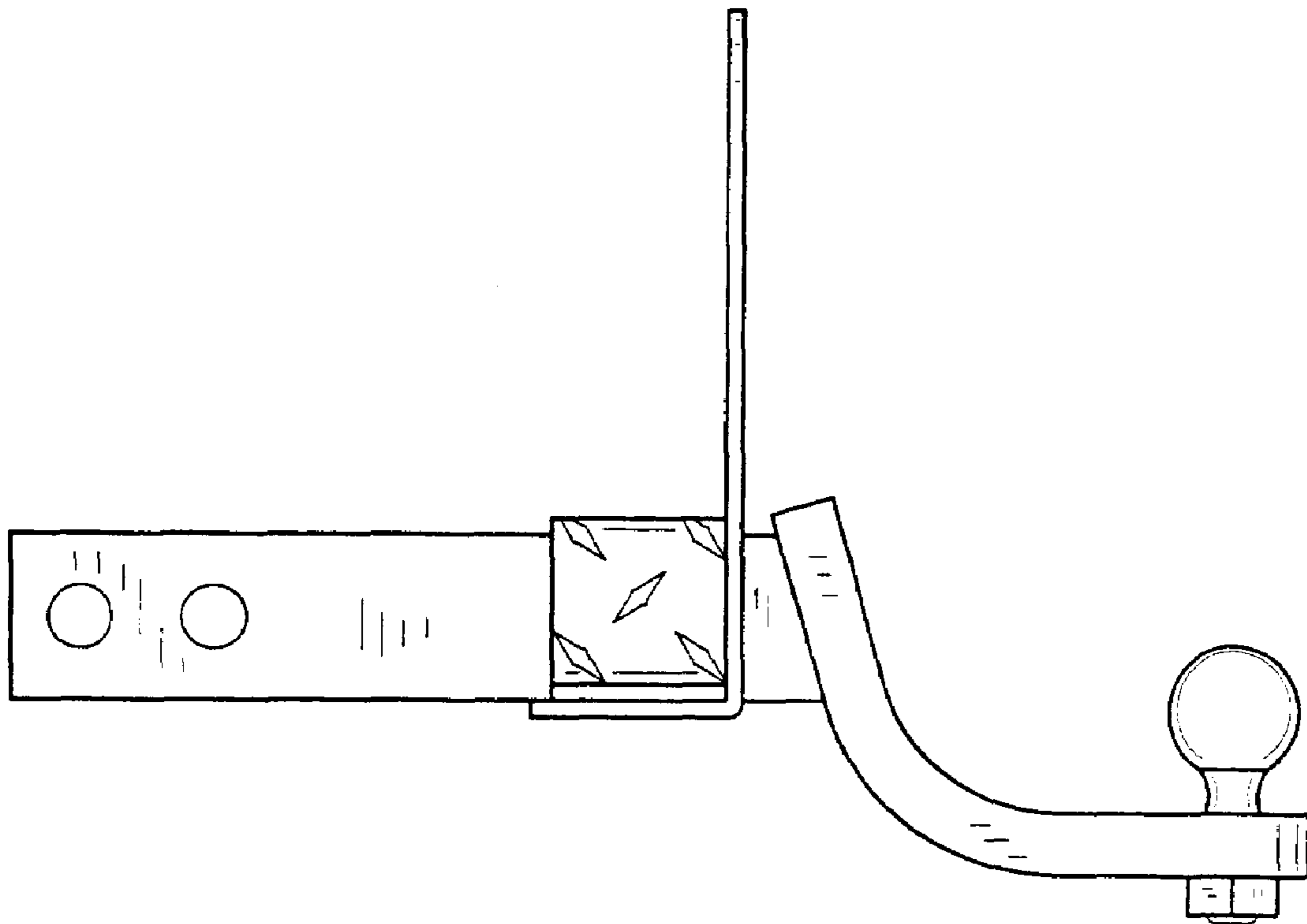
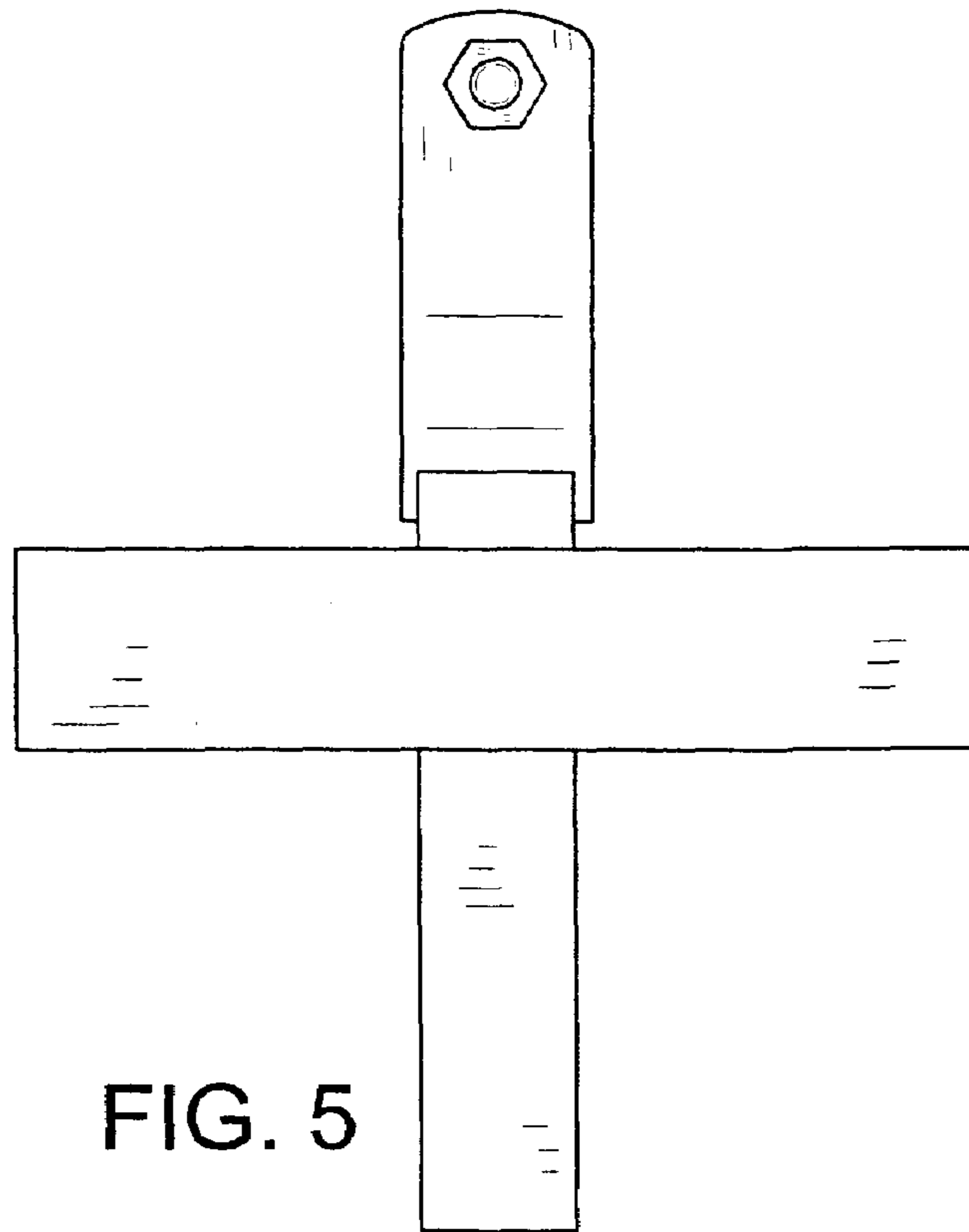
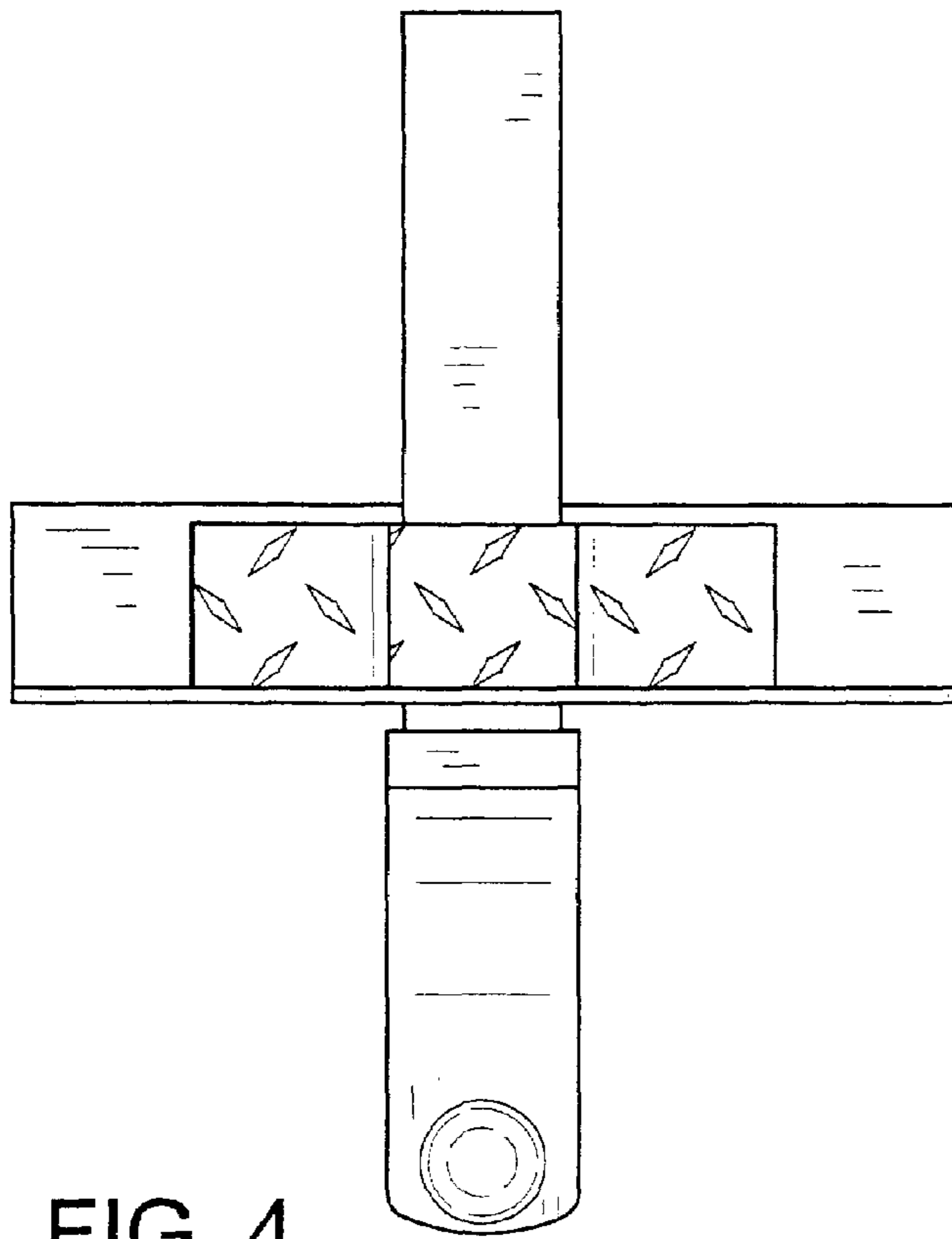

FIG. 3



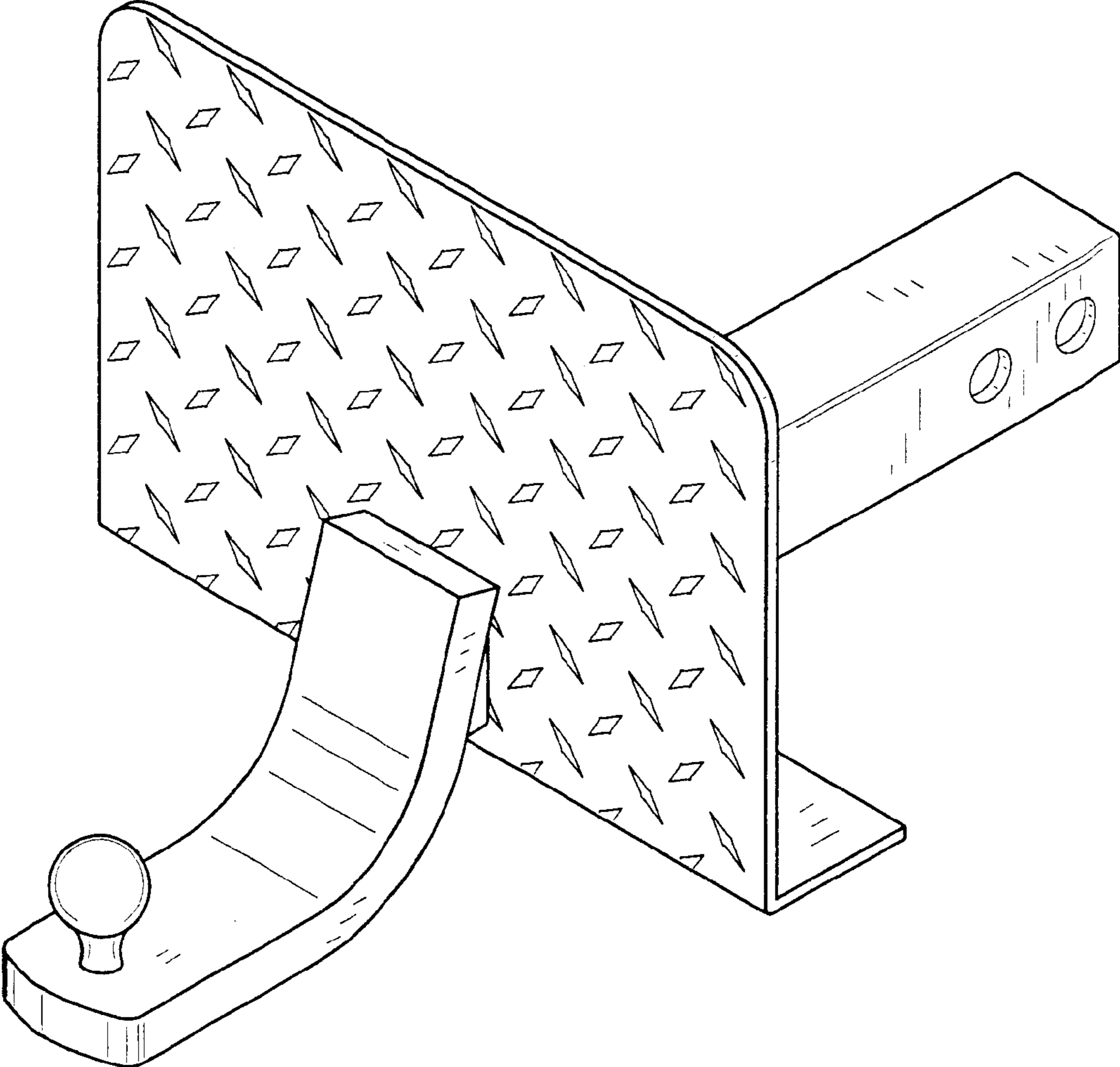

FIG. 6