



US00D576465S

(12) **United States Design Patent**  
**Brown**

(10) **Patent No.:** **US D576,465 S**  
(45) **Date of Patent:** **\*\* Sep. 9, 2008**

- (54) **FOLDABLE DRIVER TOOL**
- (75) Inventor: **Daniel P. Brown**, Palos Park, IL (US)
- (73) Assignee: **Loggerhead Tools LLC**, Palos Park, IL (US)
- (\*\*) Term: **14 Years**
- (21) Appl. No.: **29/279,752**
- (22) Filed: **May 7, 2007**
- (51) **LOC (8) Cl.** ..... **08-04**
- (52) **U.S. Cl.** ..... **D8/85; D8/83**
- (58) **Field of Classification Search** ..... D8/82, D8/83, 84, 85, 86, 87, 105, 107; D3/905; 81/177.1, 177.4, 177.8, 439, 440; 206/375  
See application file for complete search history.

4,934,223 A	6/1990	Wong	
4,945,639 A	8/1990	Kirby	
5,280,659 A	1/1994	Park	
5,421,225 A *	6/1995	Chen .....	81/490
5,427,003 A	6/1995	Boltak et al.	
5,437,212 A	8/1995	Thompson et al.	
5,450,774 A	9/1995	Chang	
5,499,562 A	3/1996	Feng	
5,512,165 A	4/1996	Liu	
5,517,885 A	5/1996	Feng	
5,522,291 A	6/1996	Liu	
5,535,882 A	7/1996	Liu	
5,570,616 A	11/1996	Thompson et al.	
5,600,914 A	2/1997	Tatar	
D385,172 S	10/1997	Bramsiepe et al.	
5,711,042 A	1/1998	Chuang	
5,711,194 A	1/1998	Anderson et al.	

(Continued)

(56) **References Cited**  
U.S. PATENT DOCUMENTS

981,278 A	1/1911	Jenks	
1,407,652 A	2/1922	Hallvarson	
1,816,812 A	8/1931	Allison	
2,443,339 A	6/1948	Blalock	
D168,900 S	2/1953	Lutsker	
2,651,840 A	9/1953	Taylor	
2,804,970 A	9/1957	Kue et al.	
3,799,226 A	3/1974	Lavietes	
3,824,881 A	7/1974	Wright	
3,827,470 A	8/1974	Douglas et al.	
3,863,693 A	2/1975	Carriker	
4,210,185 A	7/1980	Acevedo	
4,235,269 A	11/1980	Kraus	
4,241,773 A	12/1980	Personnat	
4,341,292 A	7/1982	Acevedo	
4,434,828 A	3/1984	Trincia	
4,440,048 A	4/1984	Stevens et al.	
D276,127 S *	10/1984	Lee .....	D8/84
D276,128 S *	10/1984	Lee .....	D8/84
4,512,693 A	4/1985	Swanson	
4,546,677 A	10/1985	Berkich	
4,779,493 A	10/1988	White	
4,799,407 A	1/1989	Miyamoto	
4,848,197 A	7/1989	Kikel	

*Primary Examiner*—Philip S Hyder  
(74) *Attorney, Agent, or Firm*—Vedder Price P.C.

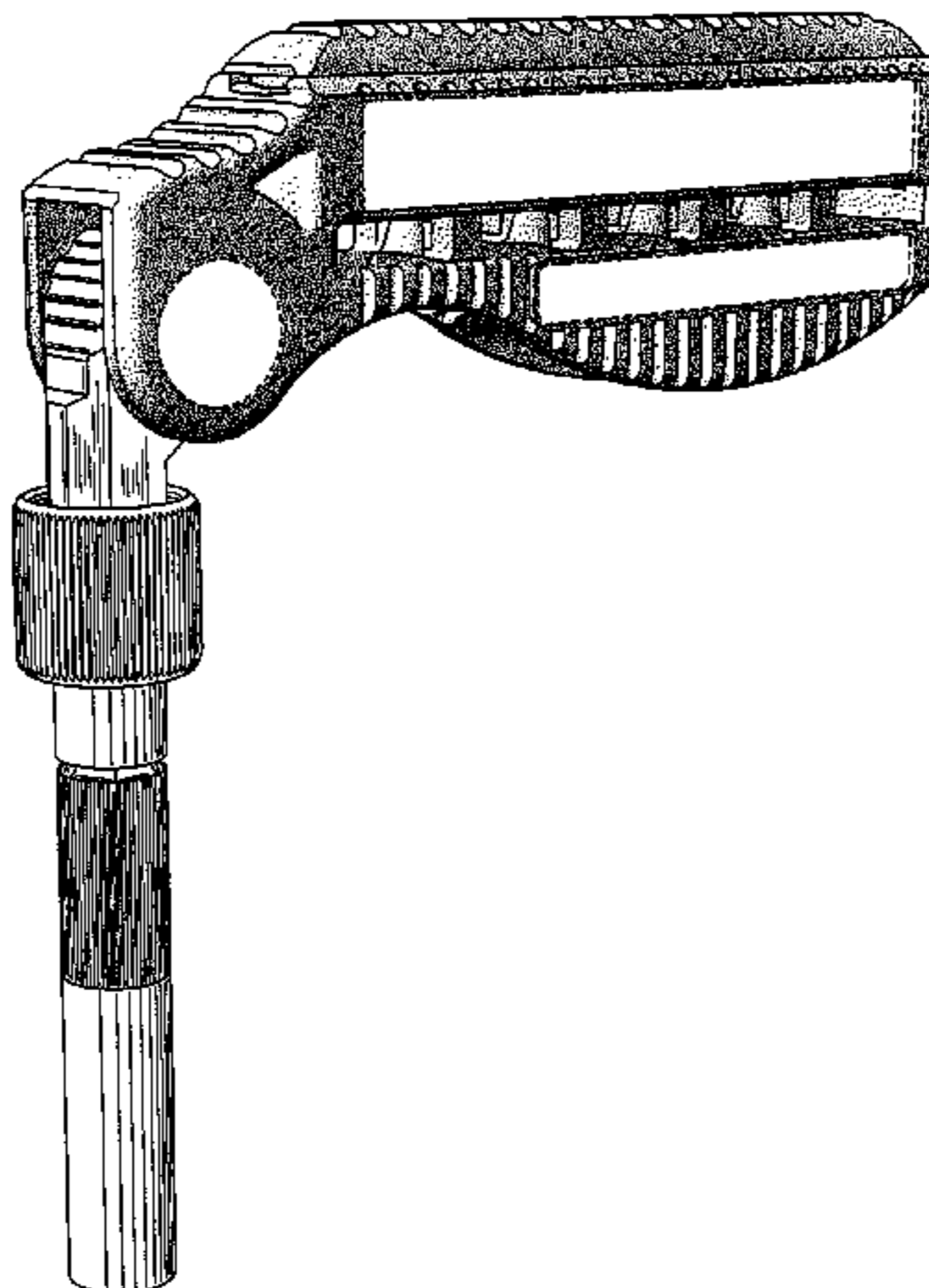
(57) **CLAIM**

The ornamental design of the foldable driver tool, as shown and described.

**DESCRIPTION**

FIG. 1 is a perspective view of a foldable driver tool showing my new design;  
 FIG. 2 is a top plan view thereof;  
 FIG. 3 is a right side elevation view thereof;  
 FIG. 4 is a front elevation view thereof;  
 FIG. 5 is a rear elevation view thereof;  
 FIG. 6 is a bottom plan view thereof; and,  
 FIG. 7 is a perspective view thereof, in the folded state.  
 The broken line portions of the folding driver tool form no part of the claimed design.

**1 Claim, 3 Drawing Sheets**

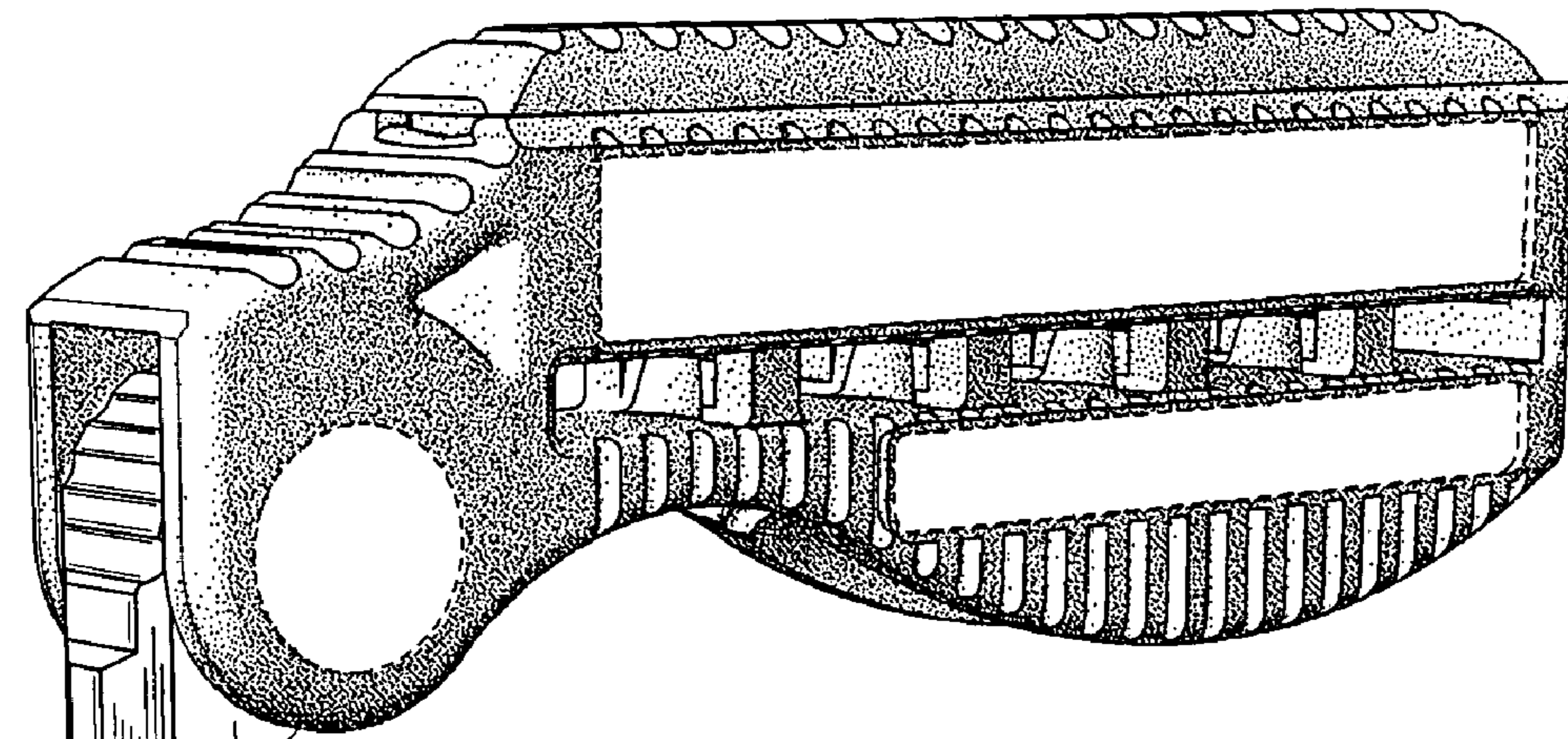


# US D576,465 S

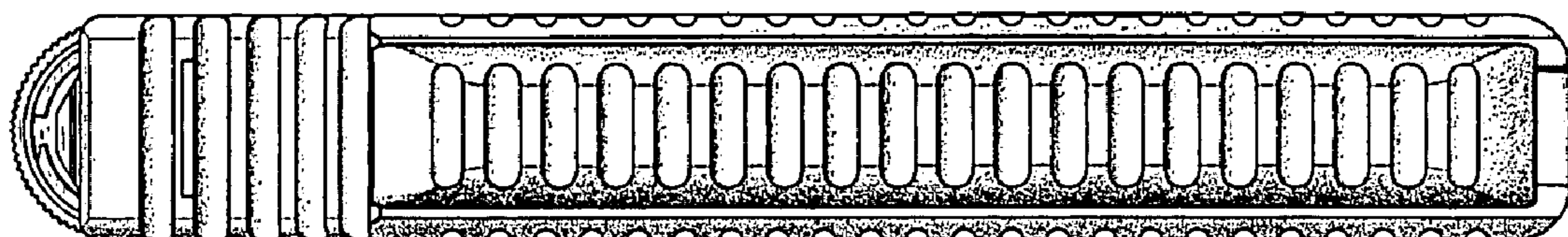
Page 2

U.S. PATENT DOCUMENTS					
			6,378,407 B1	4/2002	Purkapile
			6,397,709 B1	6/2002	Wall
5,735,005 A	4/1998	Wang	6,405,865 B1	6/2002	Lin
5,802,936 A	9/1998	Liu	6,431,034 B1	8/2002	Chen
5,809,600 A	9/1998	Cachot	6,622,597 B2	9/2003	Chen
5,887,306 A	3/1999	Huang	6,640,675 B1	11/2003	Chuang
5,894,765 A	4/1999	Anderson et al.	6,732,613 B2	5/2004	Hsieh
5,918,513 A	7/1999	Ho	6,739,224 B1	5/2004	Wershe
5,927,162 A	7/1999	Huang	6,845,694 B2	1/2005	Ping
5,927,164 A	7/1999	Anderson et al.	6,877,186 B2 *	4/2005	Shiao ..... 16/111.1
5,964,132 A	10/1999	Chen	6,880,435 B2	4/2005	Hawkins
5,970,553 A	10/1999	Lin	6,957,492 B1	10/2005	Westfall
5,970,828 A	10/1999	Bondhus et al.	D515,391 S	2/2006	Hawkins
6,023,805 A	2/2000	Lin	7,032,483 B2	4/2006	Liu
6,047,619 A	4/2000	Anderson et al.	7,039,975 B1	5/2006	Liao
6,082,232 A	7/2000	Anderson et al.	7,047,846 B1 *	5/2006	Hu ..... 81/177.7
6,101,654 A	8/2000	Cachot	7,051,629 B2	5/2006	Huang
6,109,148 A	8/2000	Anderson et al.	D523,634 S	6/2006	Dost et al.
6,119,561 A	9/2000	Anderson et al.	7,055,410 B2	6/2006	Hu
6,131,222 A	10/2000	Anderson et al.	7,066,061 B1	6/2006	Chen et al.
6,151,999 A	11/2000	Eklind	2003/0079580 A1	5/2003	Beauchamp
D435,415 S	12/2000	Johnson et al.	2003/0196273 A1	10/2003	Anderson et al.
6,196,093 B1	3/2001	Hu	2005/0284267 A1	12/2005	Liao
D440,141 S	4/2001	Yeh	2006/0048610 A1	3/2006	Hu
6,260,445 B1	7/2001	DeVecchis et al.	2006/0162508 A1	7/2006	Liu
6,286,397 B1	9/2001	Taggart et al.	2006/0225537 A1	10/2006	Shiao
6,341,423 B1	1/2002	Taggart et al.			
6,352,010 B1	3/2002	Giarritta et al.			

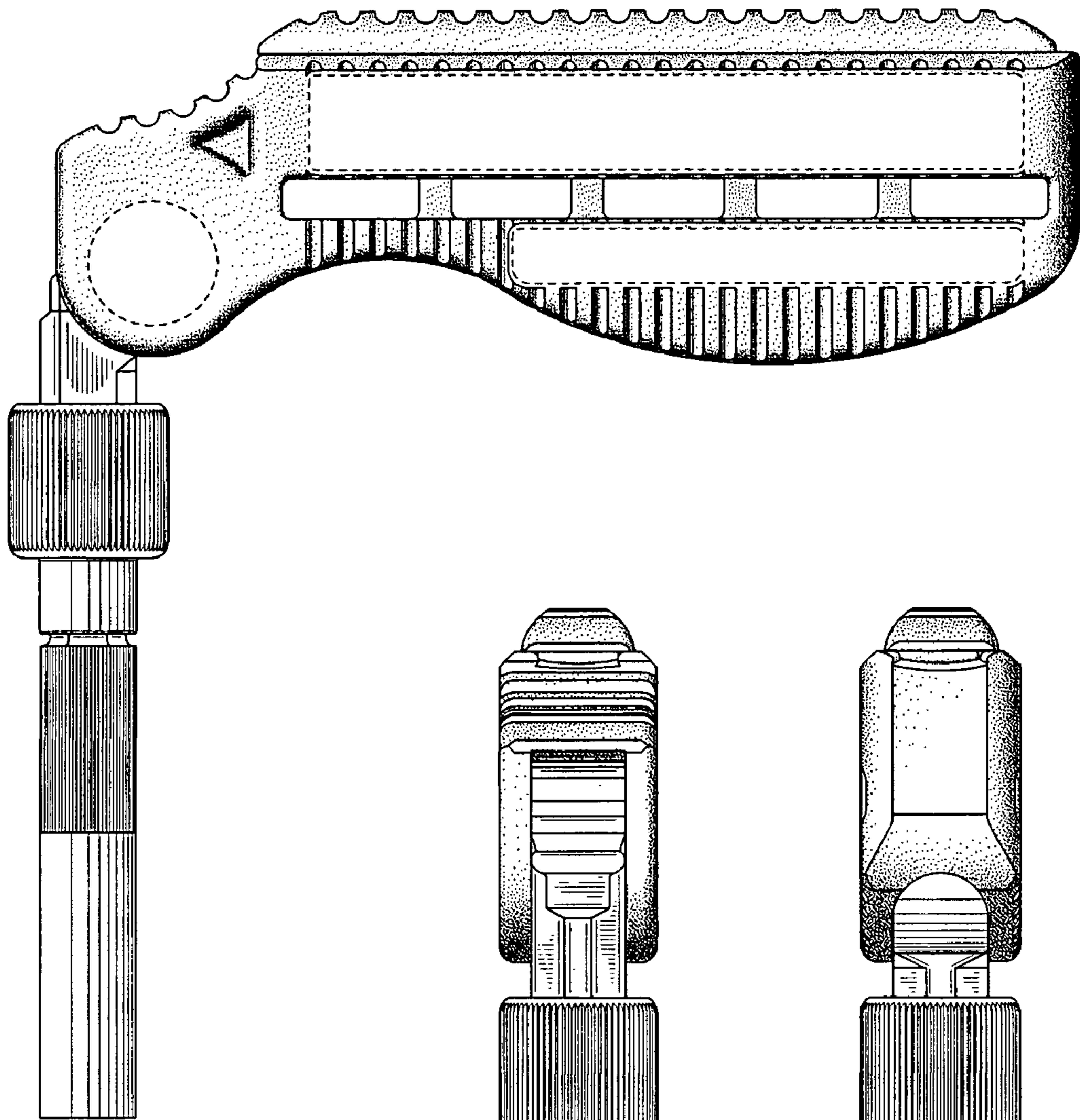
\* cited by examiner



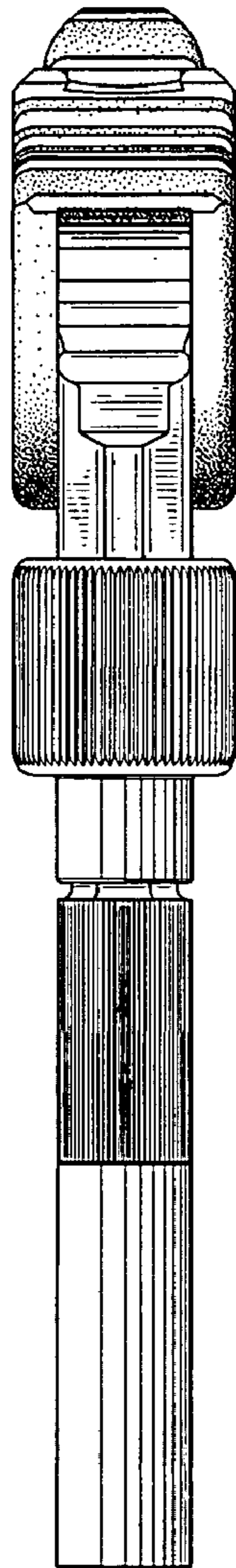
**FIG. 1**



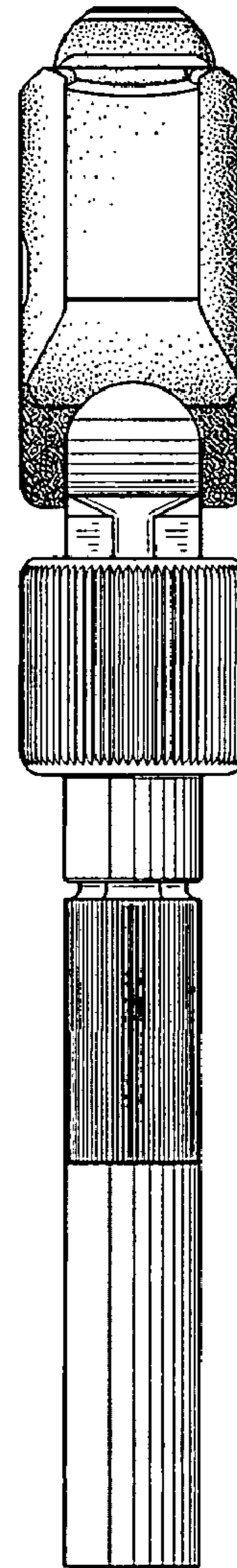
**FIG. 2**



**FIG. 3**

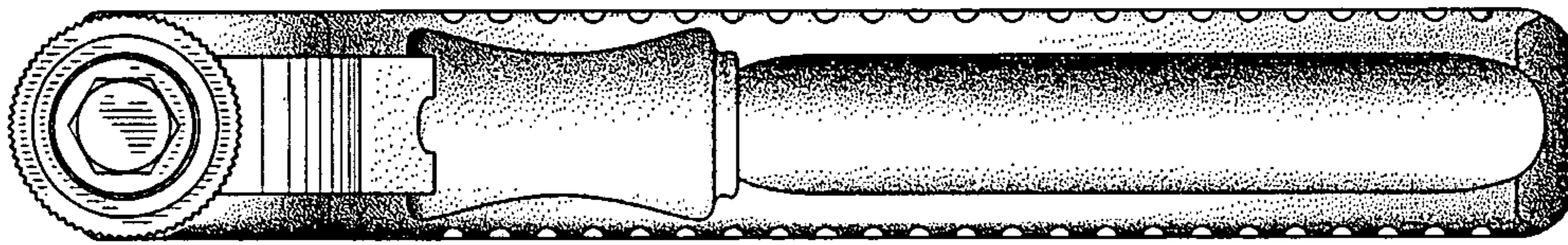


**FIG. 4**



**FIG. 5**

**FIG. 6**



**FIG. 7**

