



US00D576463S

(12) **United States Design Patent**
Franks, Jr.

(10) **Patent No.:** **US D576,463 S**

(45) **Date of Patent:** **** Sep. 9, 2008**

(54) **LIP MOUNT METER BOX CLAMP**

(75) **Inventor:** **George J. Franks, Jr.**, Inverness, IL
(US)

(73) **Assignee:** **Senior Industries, Inc.**, Wood Dale, IL
(US)

(**) **Term:** **14 Years**

(21) **Appl. No.:** **29/250,406**

(22) **Filed:** **Nov. 13, 2006**

(51) **LOC (8) Cl.** **08-05**

(52) **U.S. Cl.** **D8/72**

(58) **Field of Classification Search** D8/71-74,
D8/394-397, 354-356, 382, 383, 364; 248/62,
248/689, 124.2, 643; 81/487, 427, 321; 269/3,
269/6, 143, 165, 240, 249, 243, 97; 29/256,
29/257, 276; D15/140; 439/801, 803; D13/133,
D13/120; D24/135

See application file for complete search history.

(56) **References Cited**

U.S. PATENT DOCUMENTS

3,431,538	A *	3/1969	Hubbard et al.	D8/395
D265,171	S *	6/1982	Zukaitis	D8/356
4,538,340	A *	9/1985	Ricke	269/249
D392,171	S *	3/1998	Miller	D8/72
D393,998	S *	5/1998	Anderson	D8/394
D395,997	S *	7/1998	Coll et al.	D8/354
D407,010	S *	3/1999	Sobczynski	D8/354
D440,853	S *	4/2001	Welsh et al.	D8/73

D442,065	S *	5/2001	Rohde	D8/356
D443,493	S *	6/2001	Skeem	D8/72
6,342,138	B1 *	1/2002	Brown	248/389
D454,479	S *	3/2002	Kolpin	D8/355
D460,400	S *	7/2002	Manthei	D8/354
D464,250	S *	10/2002	Warner et al.	D8/355
D480,361	S *	10/2003	Lee	D13/133
D502,388	S *	3/2005	Cortez et al.	D8/356
D508,676	S *	8/2005	Franks, Jr.	D13/133
D548,050	S *	8/2007	Yamamoto	D8/354

* cited by examiner

Primary Examiner—Louis S Zarfaz

Assistant Examiner—Davud G Muller

(74) *Attorney, Agent, or Firm*—Bell, Boyd & Lloyd LLP

(57) **CLAIM**

The ornamental design for a lip mount meter box clamp, as shown and described.

DESCRIPTION

FIG. 1 is a front elevation view of a lip mount meter box clamp according to my new design.

FIG. 2 is a back elevation view thereof;

FIG. 3 is a left side elevation view thereof;

FIG. 4 is a right side elevation view thereof;

FIG. 5 is a top plan view thereof;

FIG. 6 is a bottom plan view thereof; and,

FIG. 7 is an isometric view thereof.

1 Claim, 6 Drawing Sheets

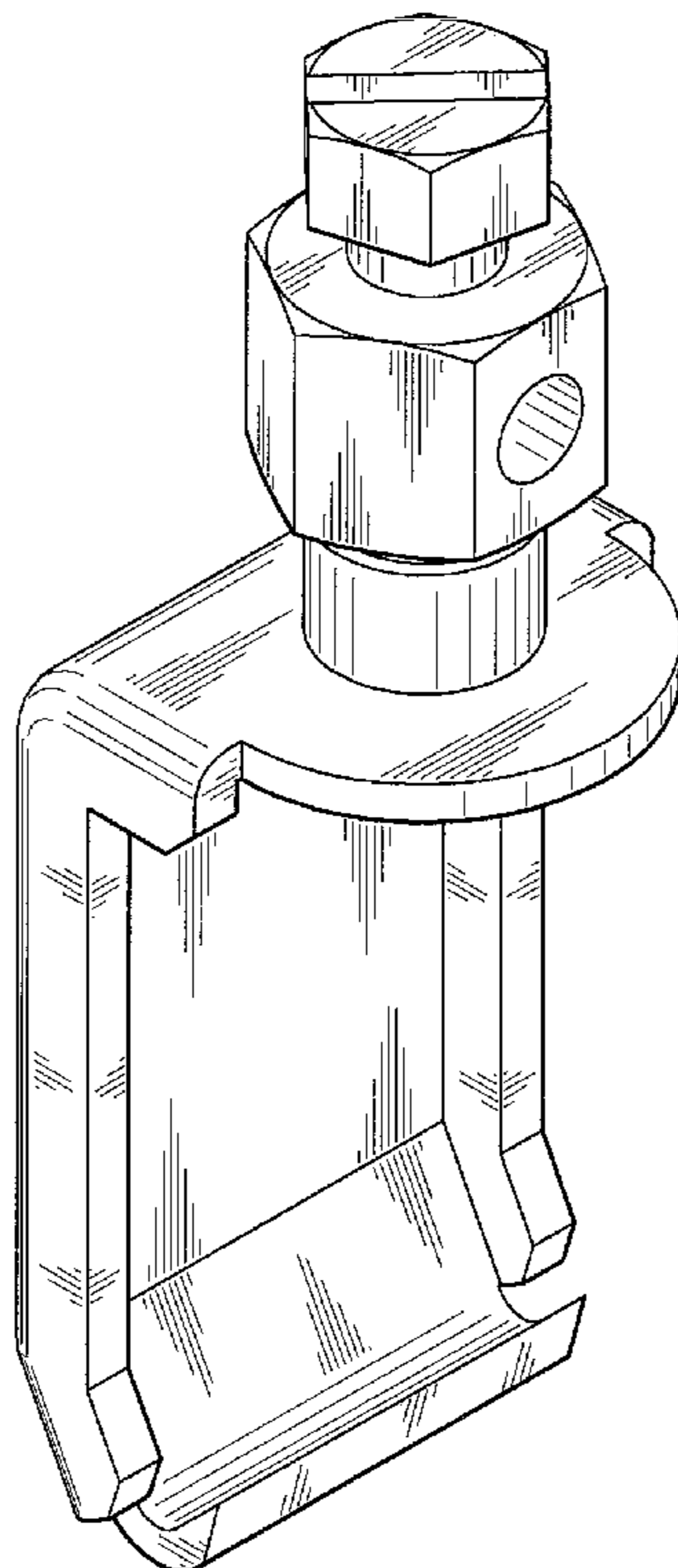

FIG. 1

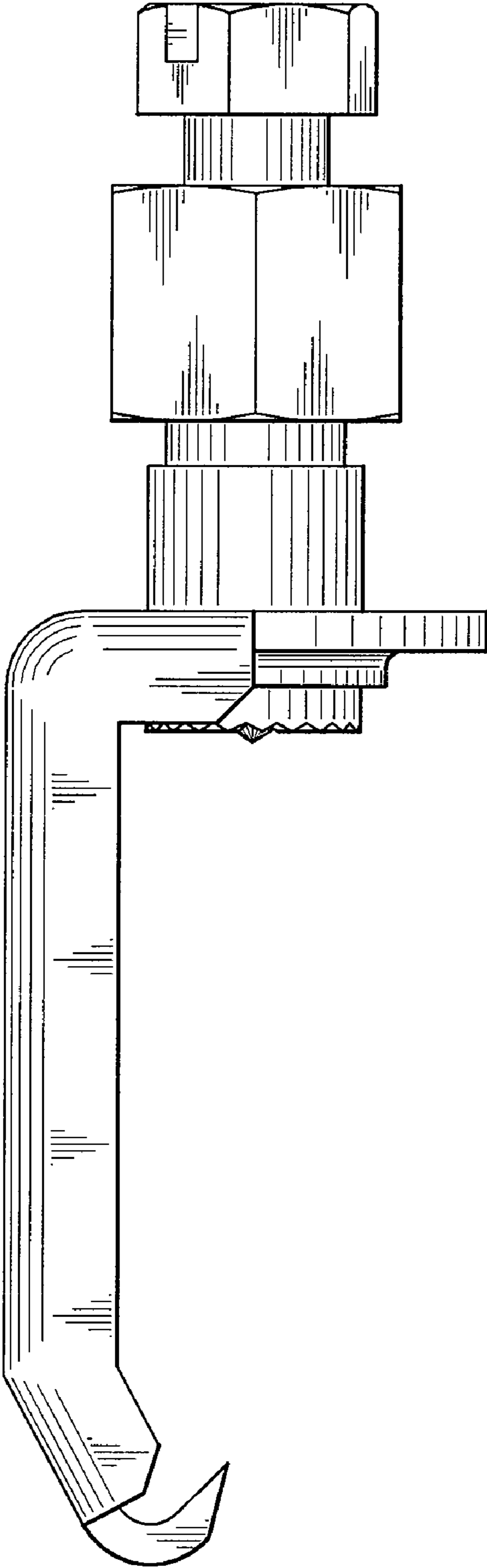

FIG. 2

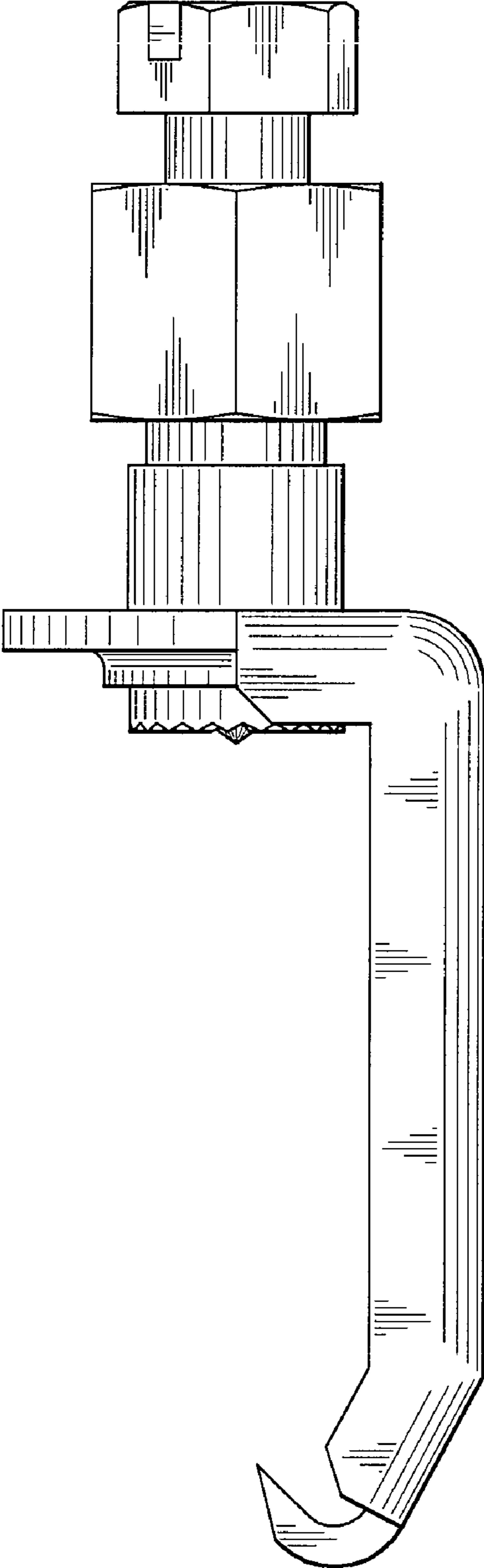

FIG. 3

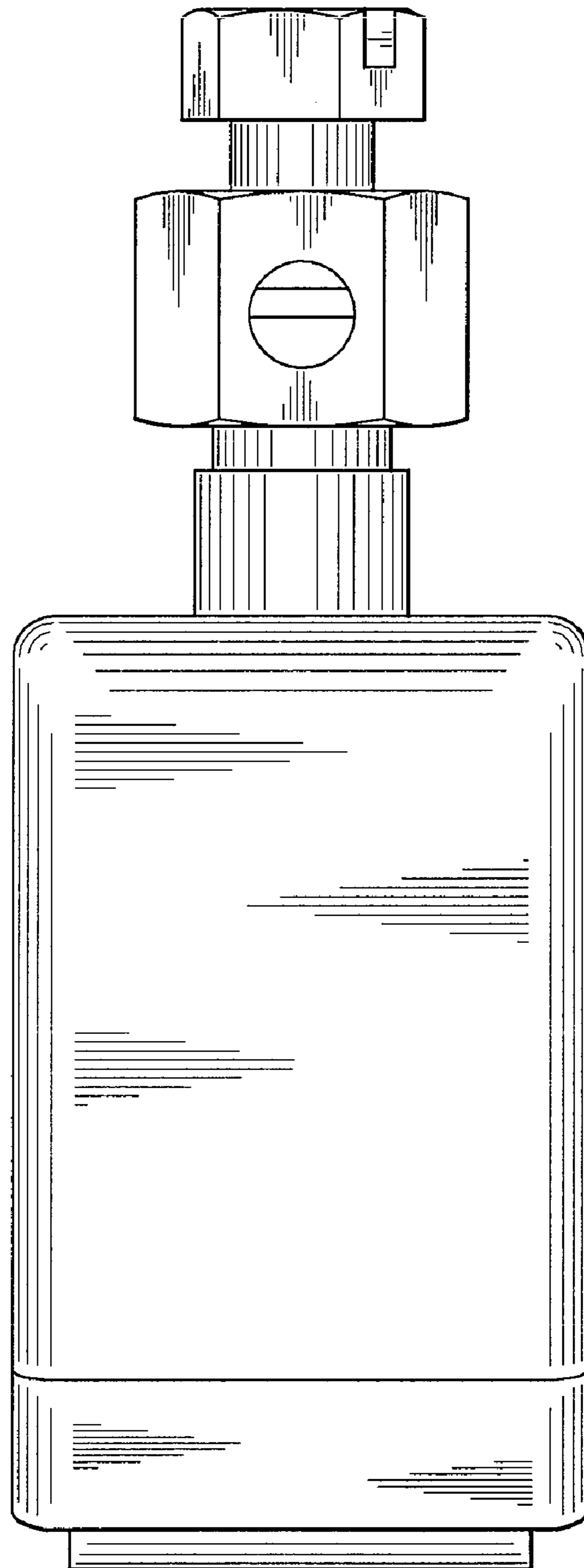

FIG. 4

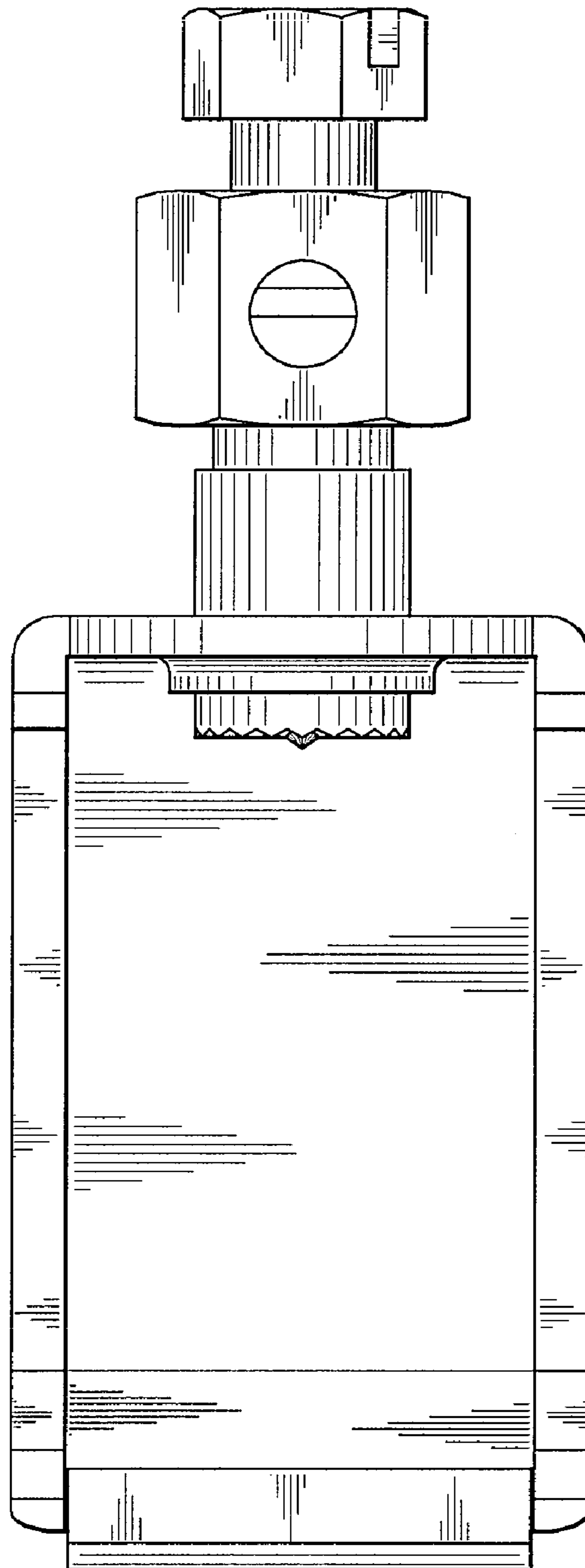

FIG. 5

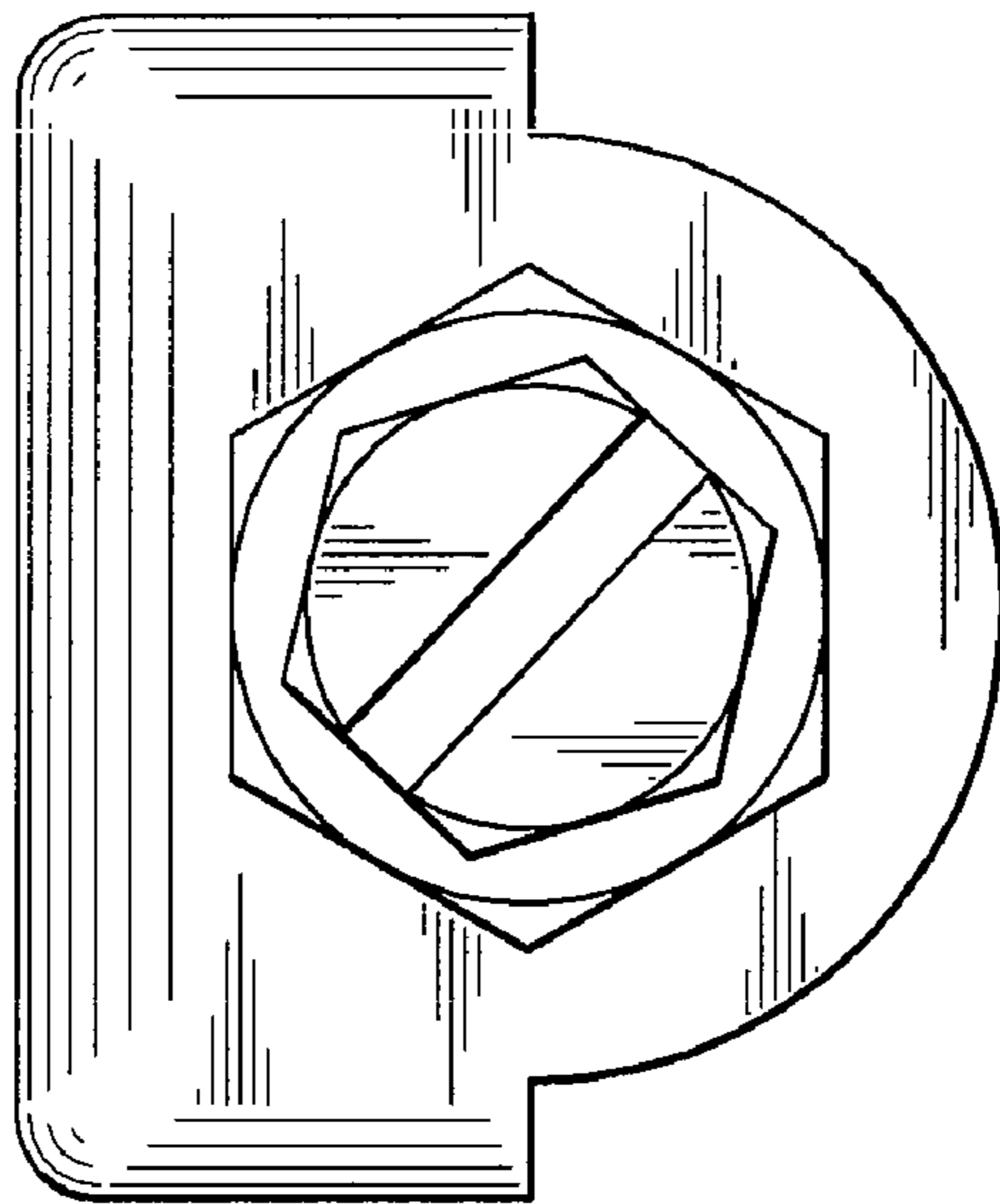

FIG. 6

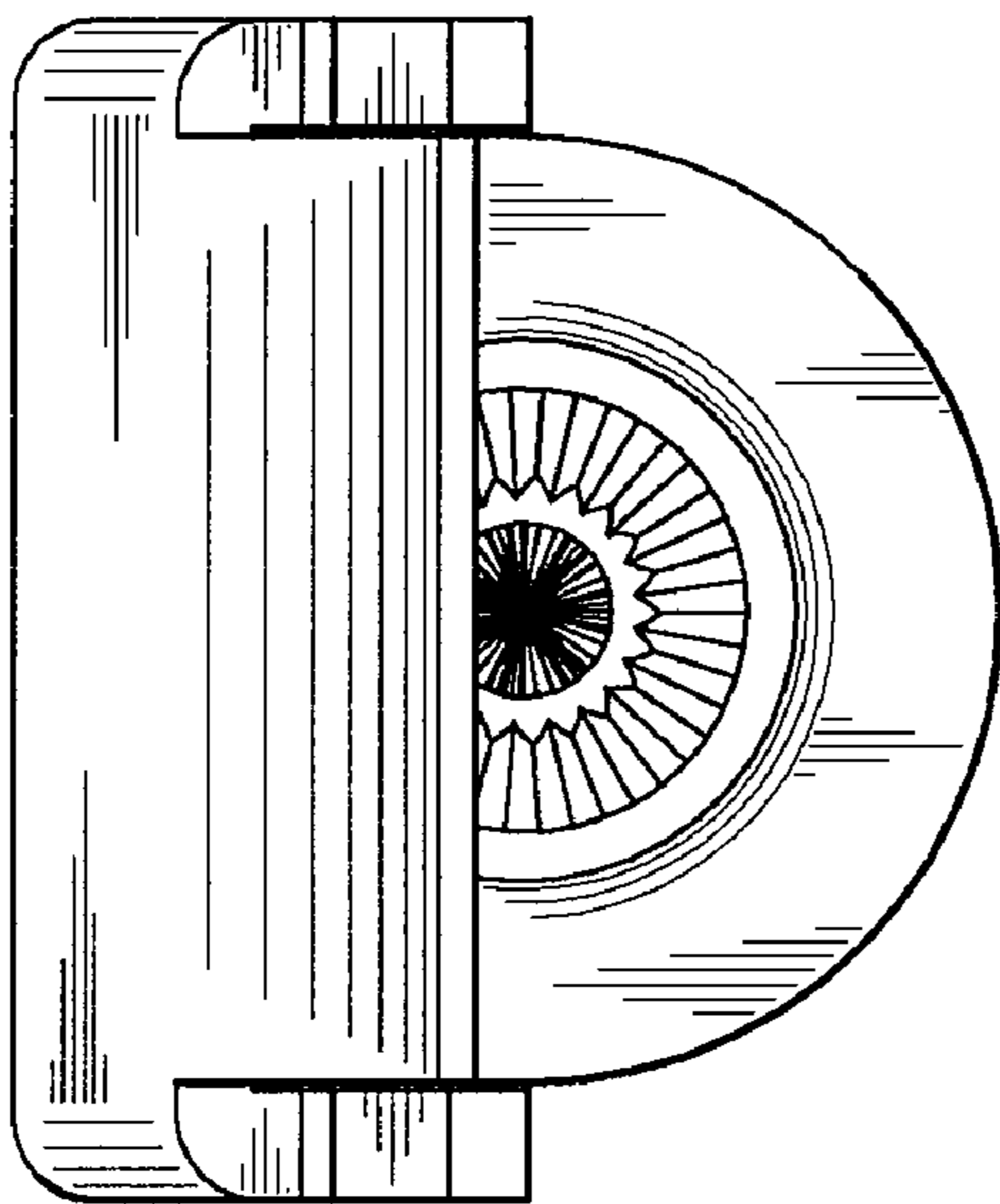

FIG. 7

