



US00D576404S

(12) **United States Design Patent**
Cooper

(10) **Patent No.:** **US D576,404 S**
(45) **Date of Patent:** **** Sep. 9, 2008**

(54) **PILL ORGANIZER**

(57) **CLAIM**

(76) Inventor: **Martin R. Cooper**, 10179 Commerce Park, Cincinnati, OH (US) 45246

The ornamental design for a pill organizer, as shown and described.

(**) Term: **14 Years**

DESCRIPTION

(21) Appl. No.: **29/293,393**

FIG. 1 is a left front perspective view of a pill organizer showing the first embodiment of my design;

(22) Filed: **Nov. 20, 2007**

FIG. 2 is a front elevational view of the pill organizer of FIG. 1;

(51) **LOC (8) Cl.** **03-01**

(52) **U.S. Cl.** **D3/203.3**

(58) **Field of Classification Search** D3/203.3, D3/203.2, 203.4, 201, 205-206; D9/732, D9/757; 206/530-539; D18/4.1-4.2; 220/524
See application file for complete search history.

FIG. 3 is a rear elevational view of the pill organizer of FIG. 1;

FIG. 4 is a left elevational view of the pill organizer of FIG. 1;

FIG. 5 is a right elevational view of the pill organizer of FIG. 1;

FIG. 6 is a top plan view of the pill organizer of FIG. 1;

FIG. 7 is a bottom plan view of the pill organizer of FIG. 1.

FIG. 8 is a left front perspective view of a pill organizer showing the second embodiment of my design;

(56) **References Cited**

U.S. PATENT DOCUMENTS

- D99,745 S * 5/1936 Garbell D18/4.2
- D393,203 S * 4/1998 Saltzman et al. D3/203.3
- D525,777 S * 8/2006 Priebe et al. D3/203.3
- D526,478 S * 8/2006 Priebe et al. D3/203.3
- D541,039 S * 4/2007 Stugelmeyer D3/203.3

FIG. 9 is a front elevational view of the pill organizer of FIG. 8;

FIG. 10 is a rear elevational view of the pill organizer of FIG. 8;

FIG. 11 is a left elevational view of the pill organizer of FIG. 8;

FIG. 12 is a right elevational view of the pill organizer of FIG. 8;

FIG. 13 is a top plan view of the pill organizer of FIG. 8; and,

FIG. 14 is a bottom plan view of the pill organizer of FIG. 8.

The phantom lines and areas shown in the figures are for illustrative purposes only and form no part of the claimed design.

* cited by examiner

Primary Examiner—Catherine R Oliver
(74) *Attorney, Agent, or Firm*—Ulmer & Berne LLP

1 Claim, 12 Drawing Sheets

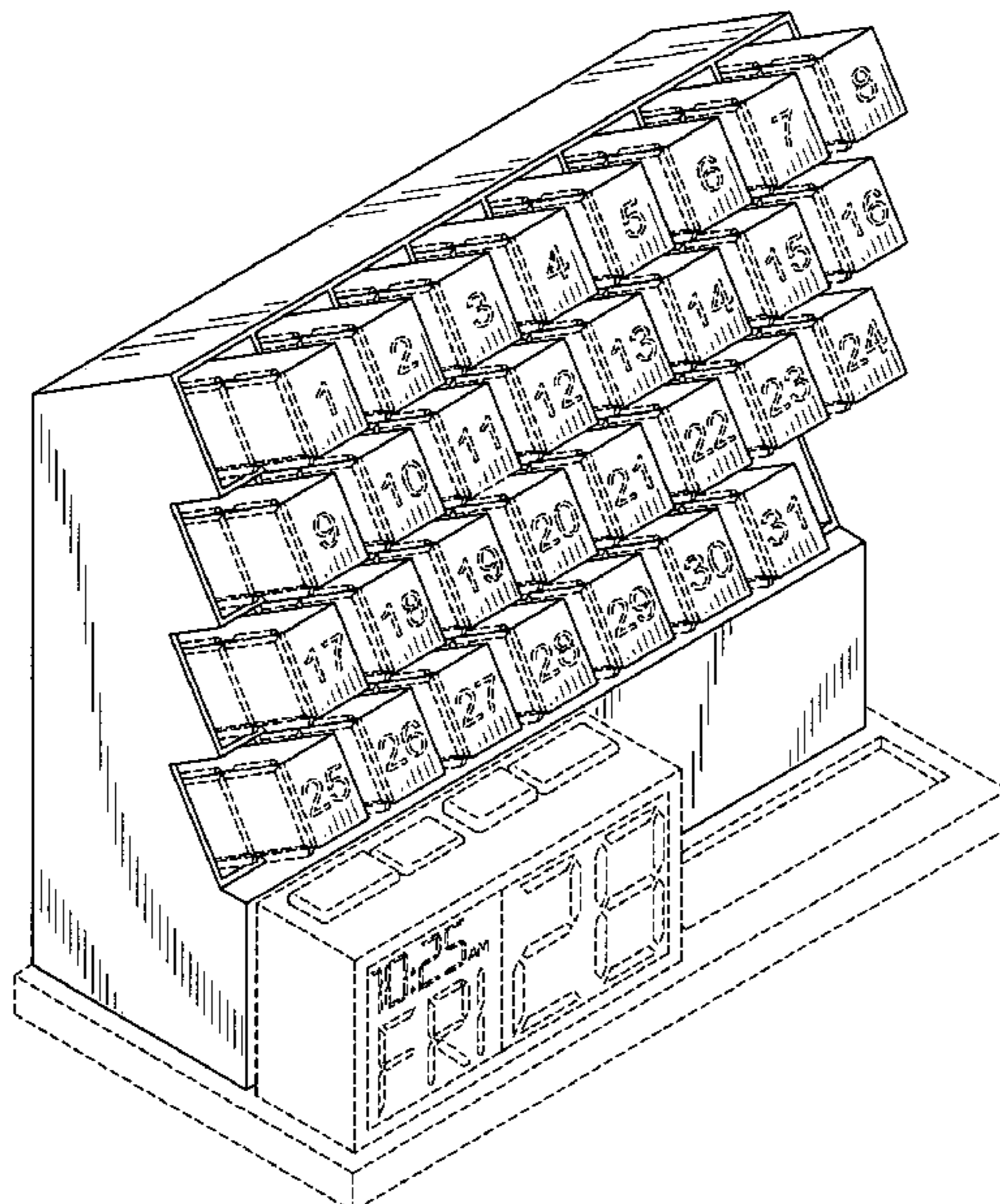

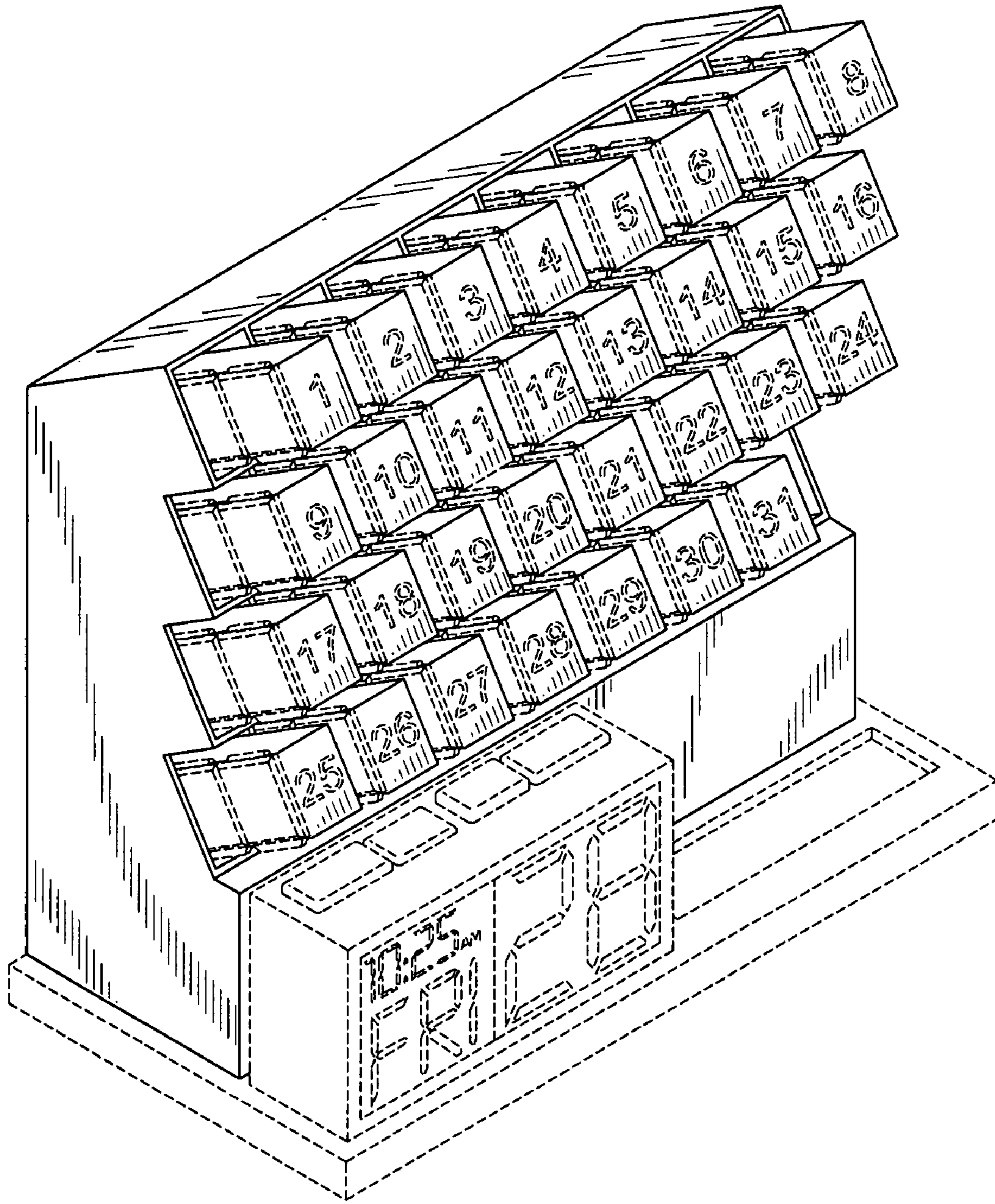

FIG. 1

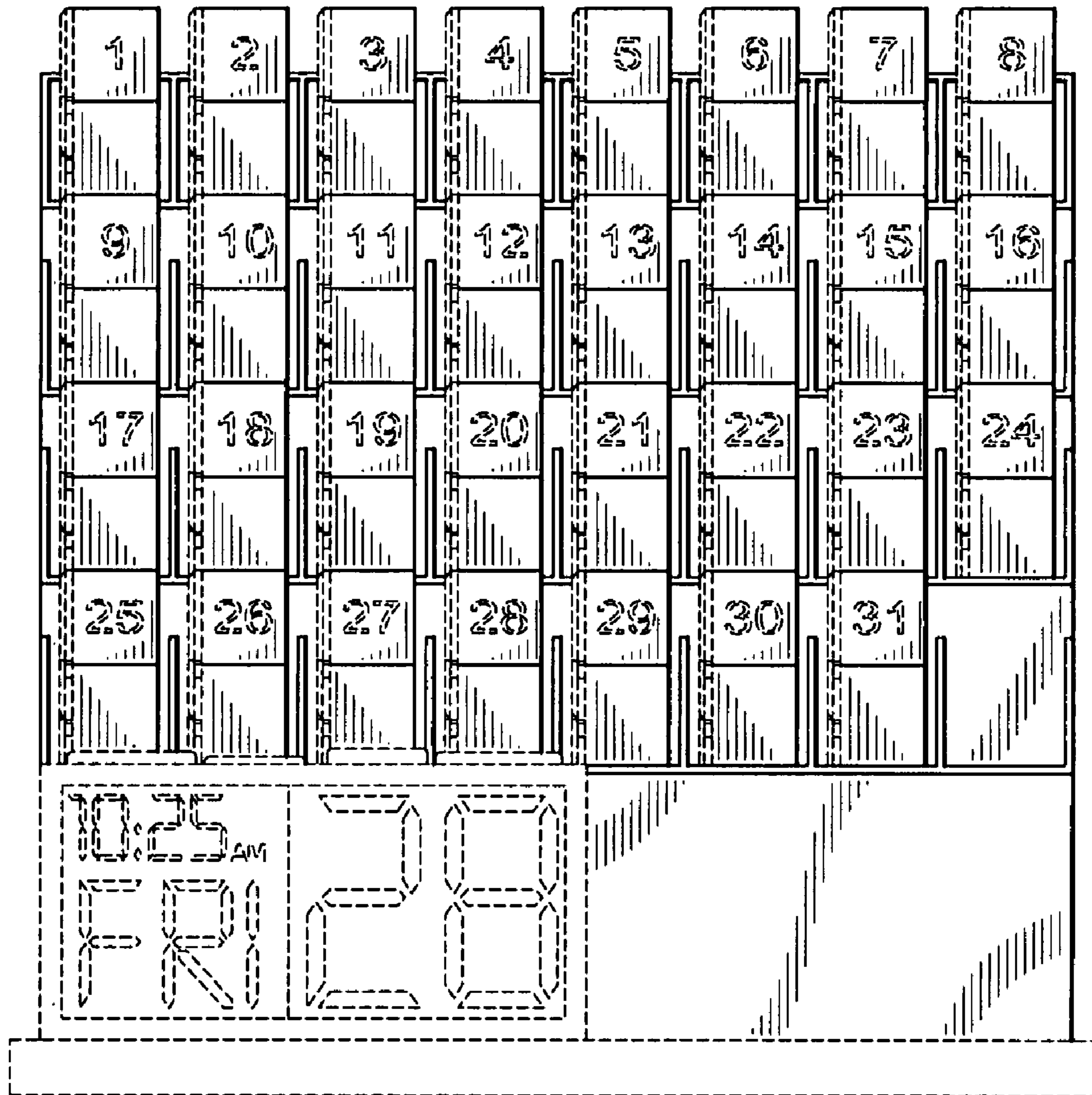

FIG. 2

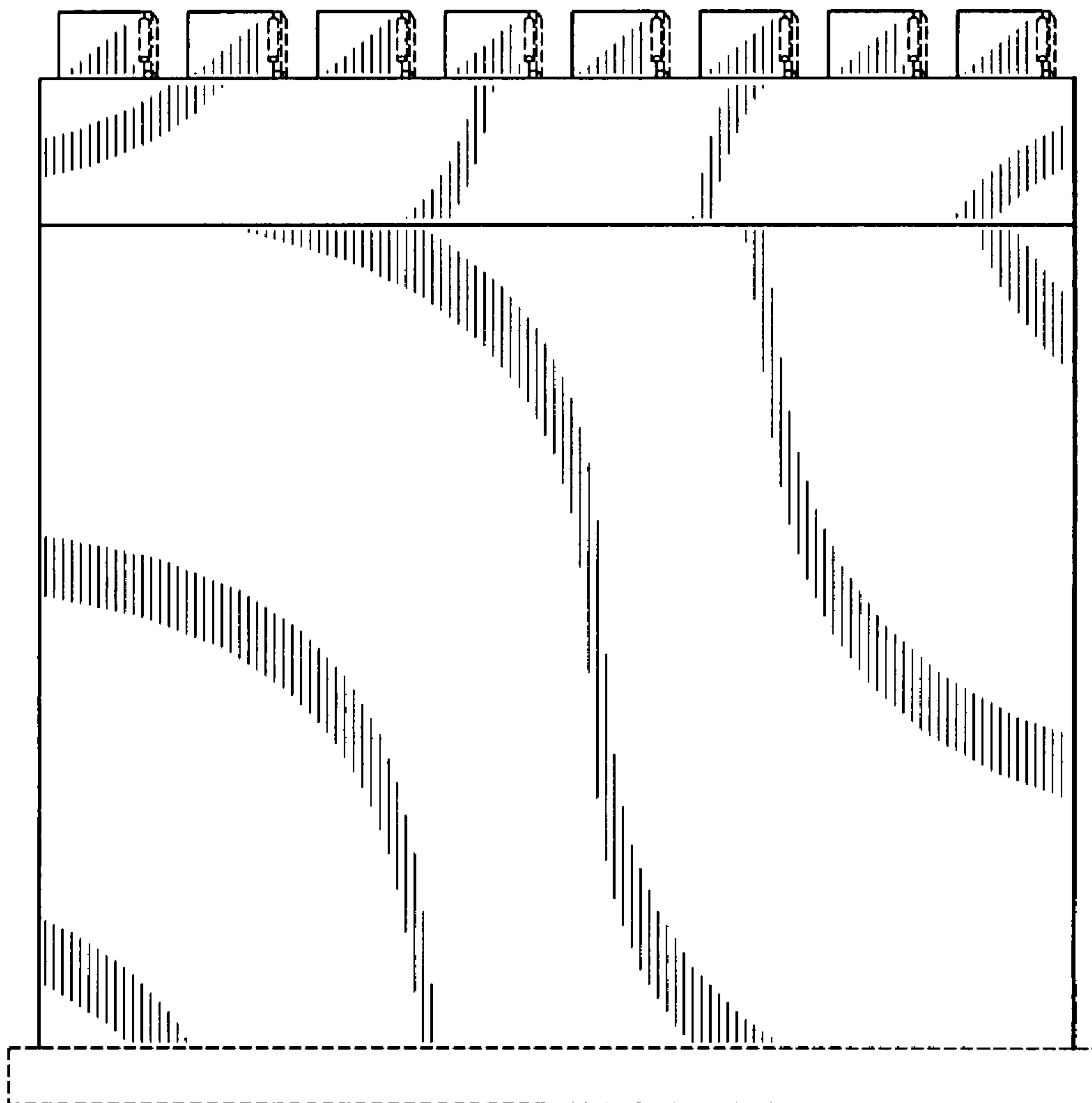

FIG. 3

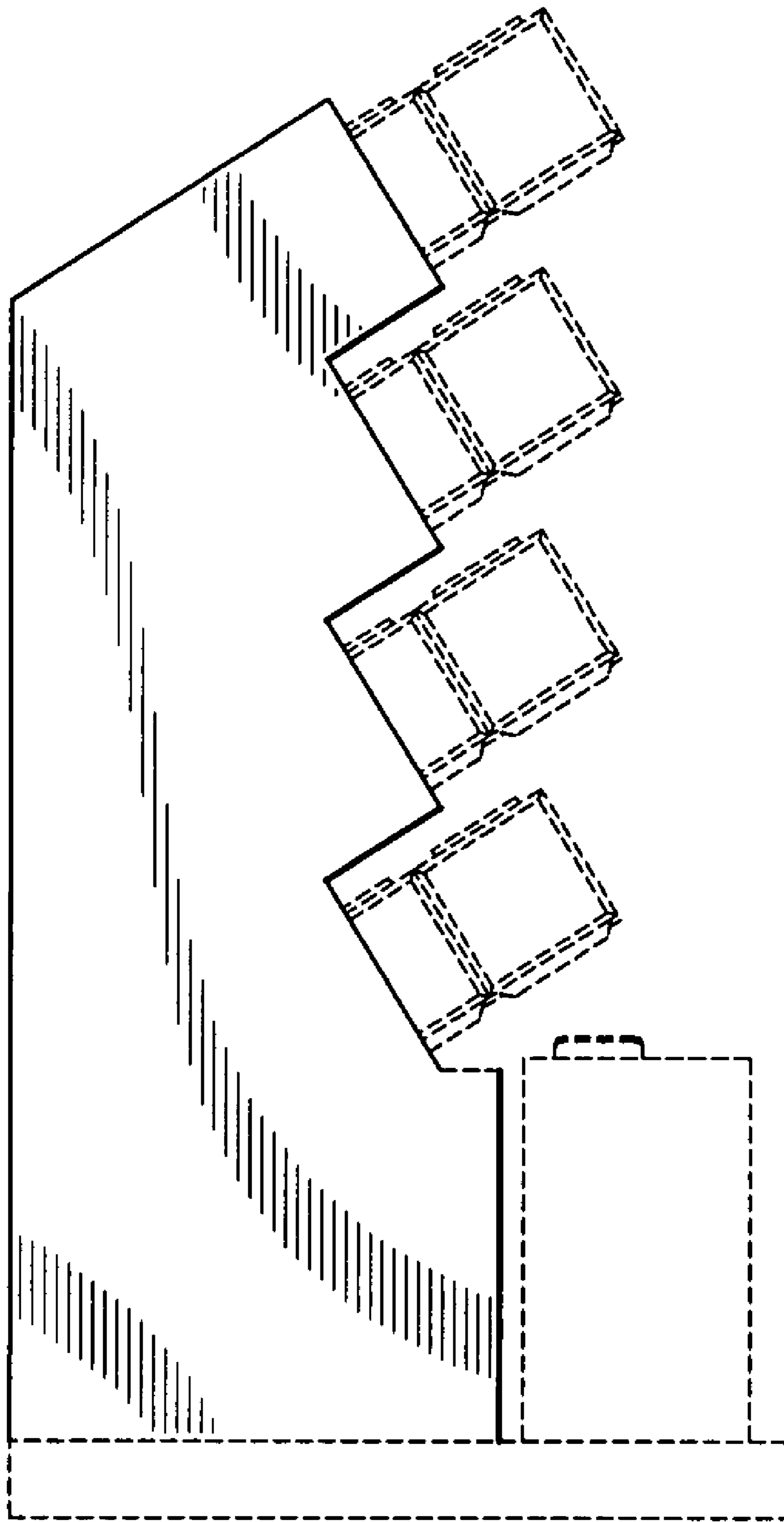

FIG. 4

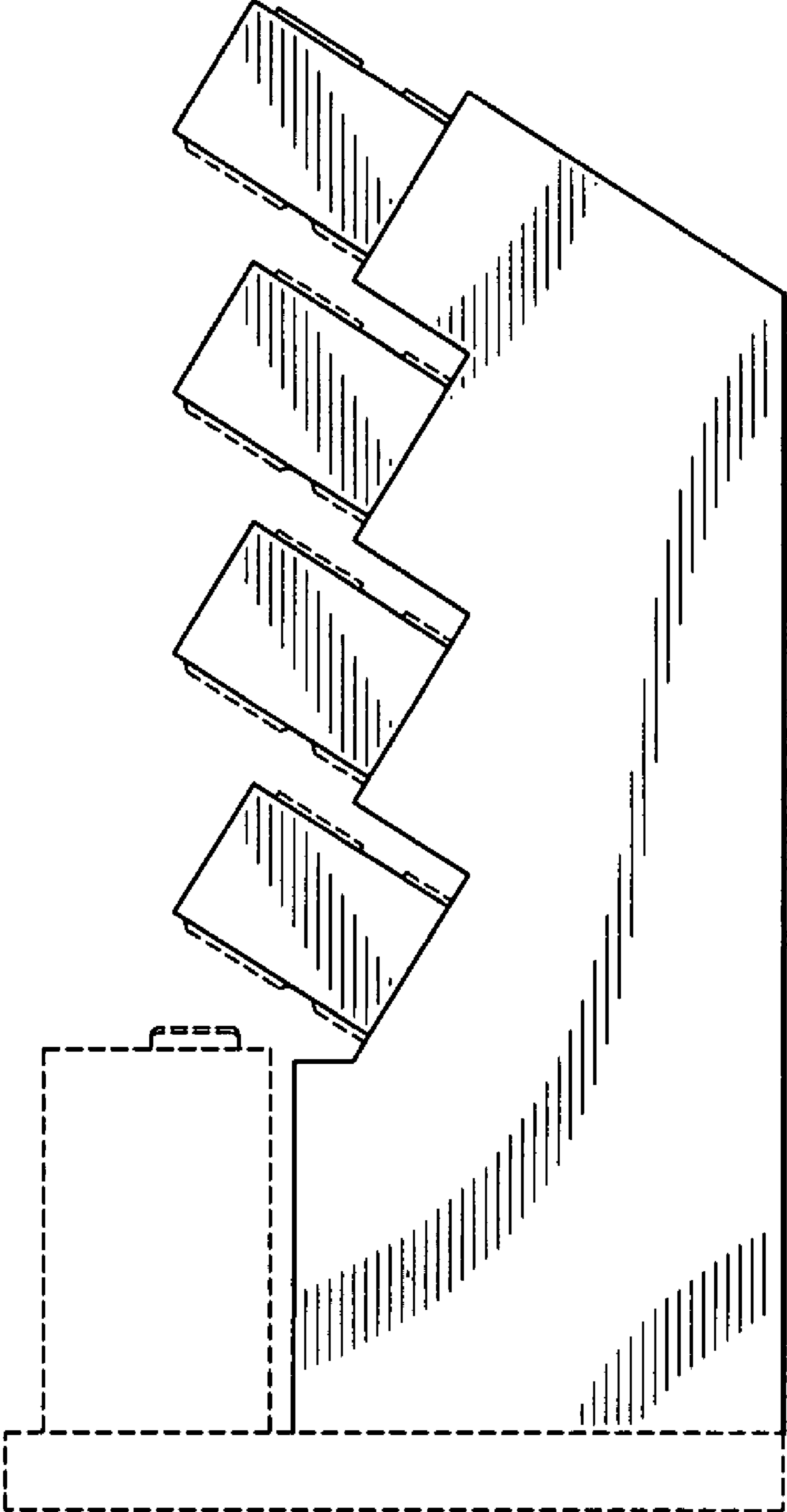

FIG. 5



FIG. 6

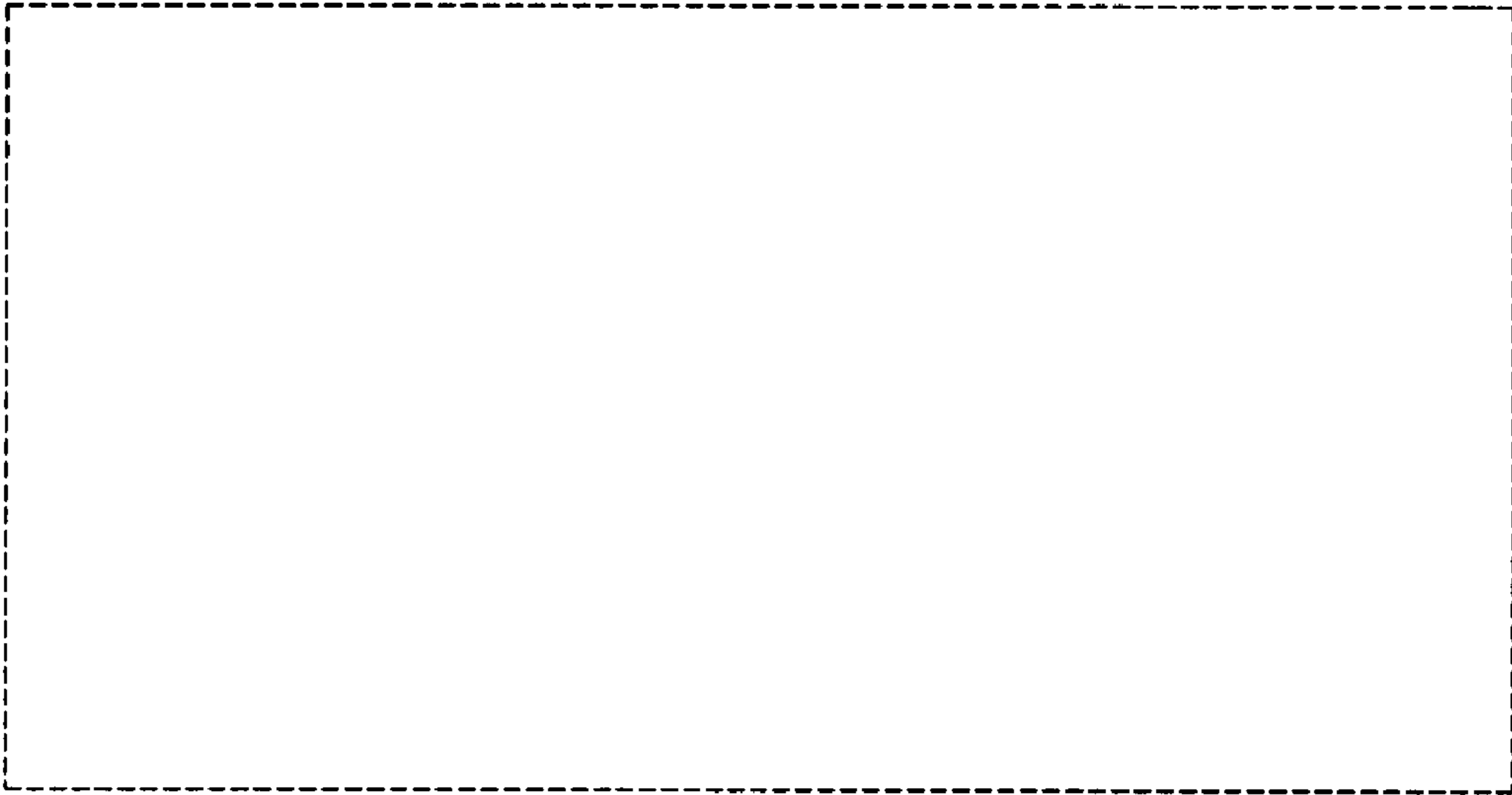

FIG. 7

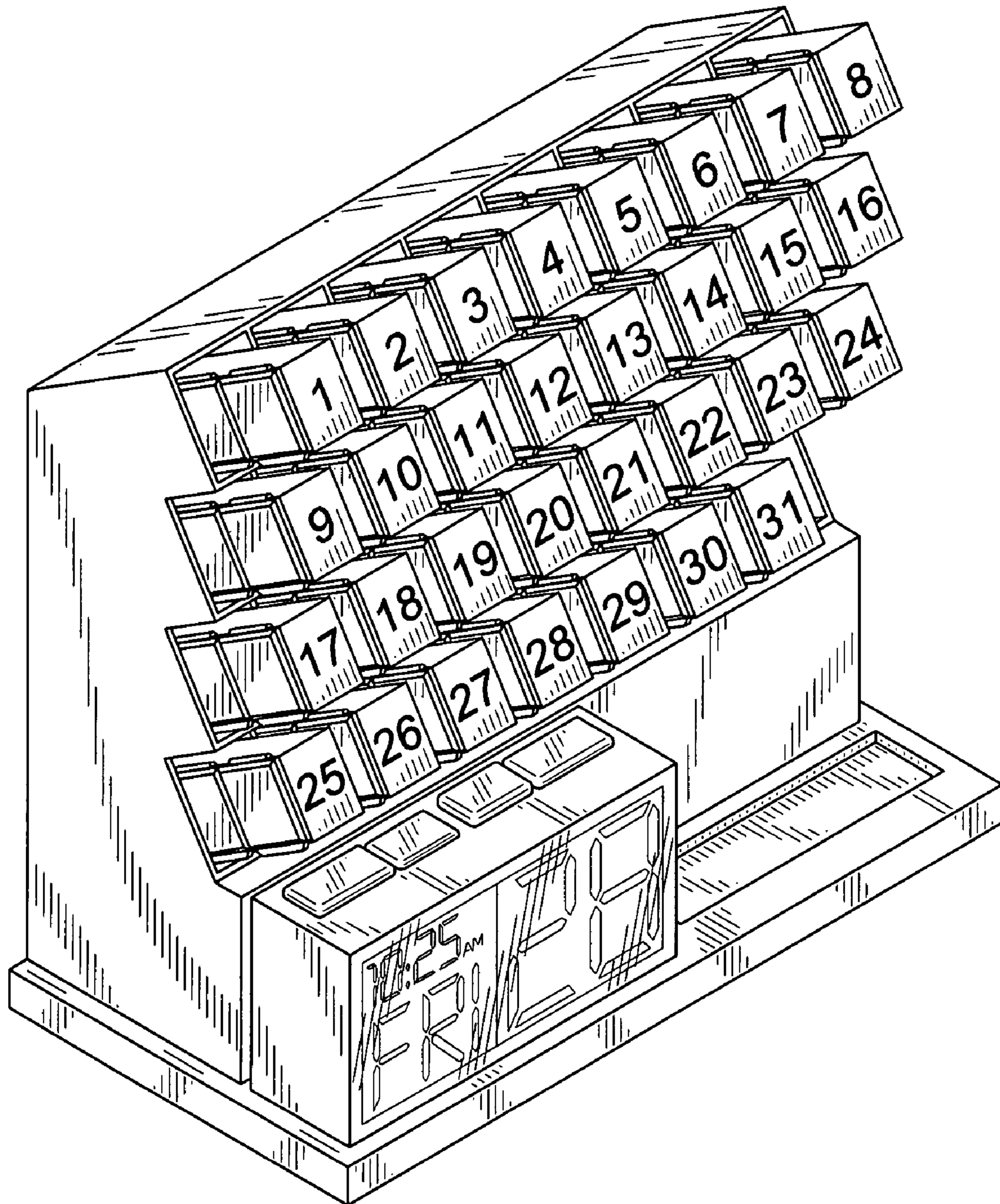

FIG. 8

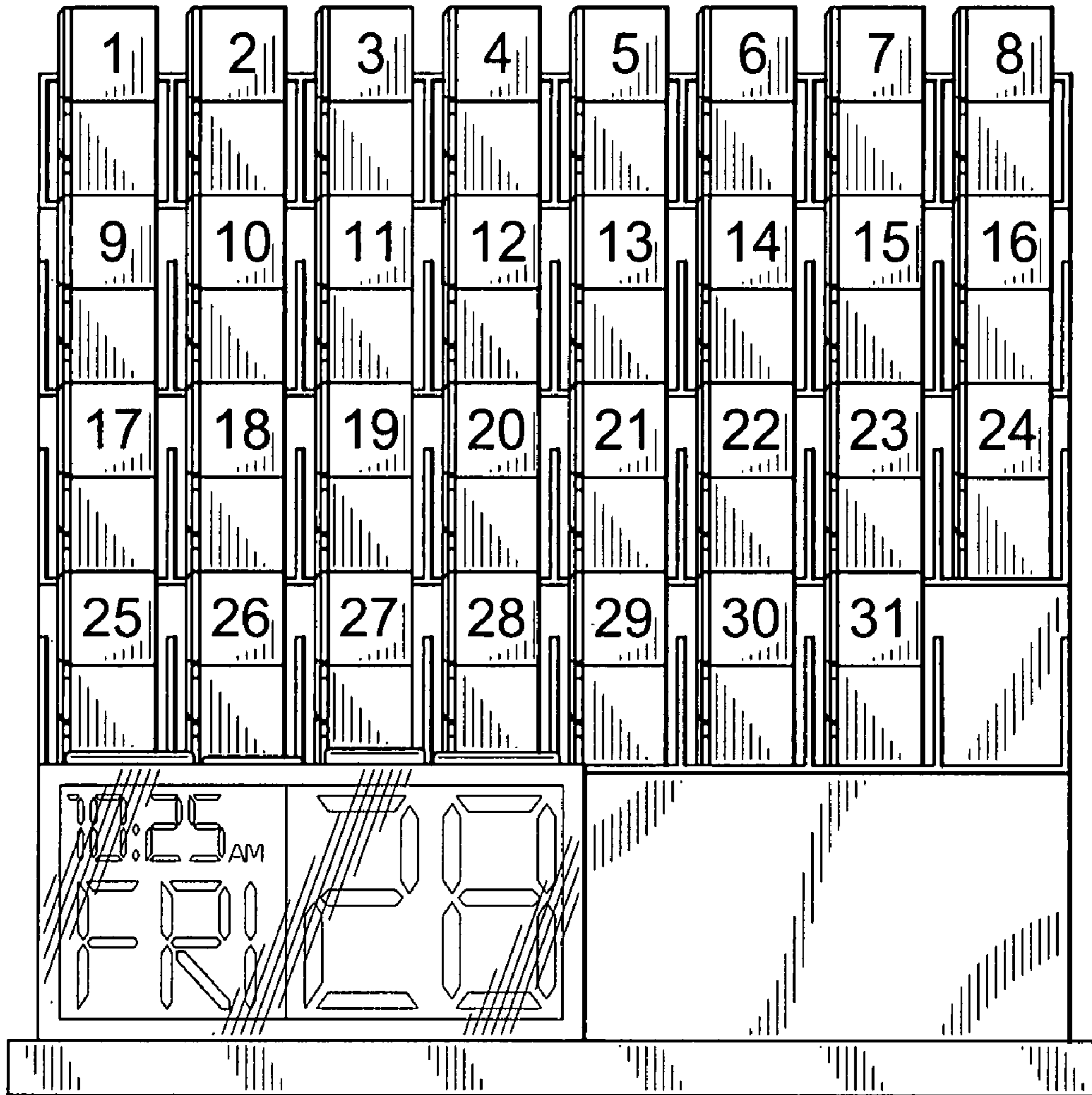

FIG. 9

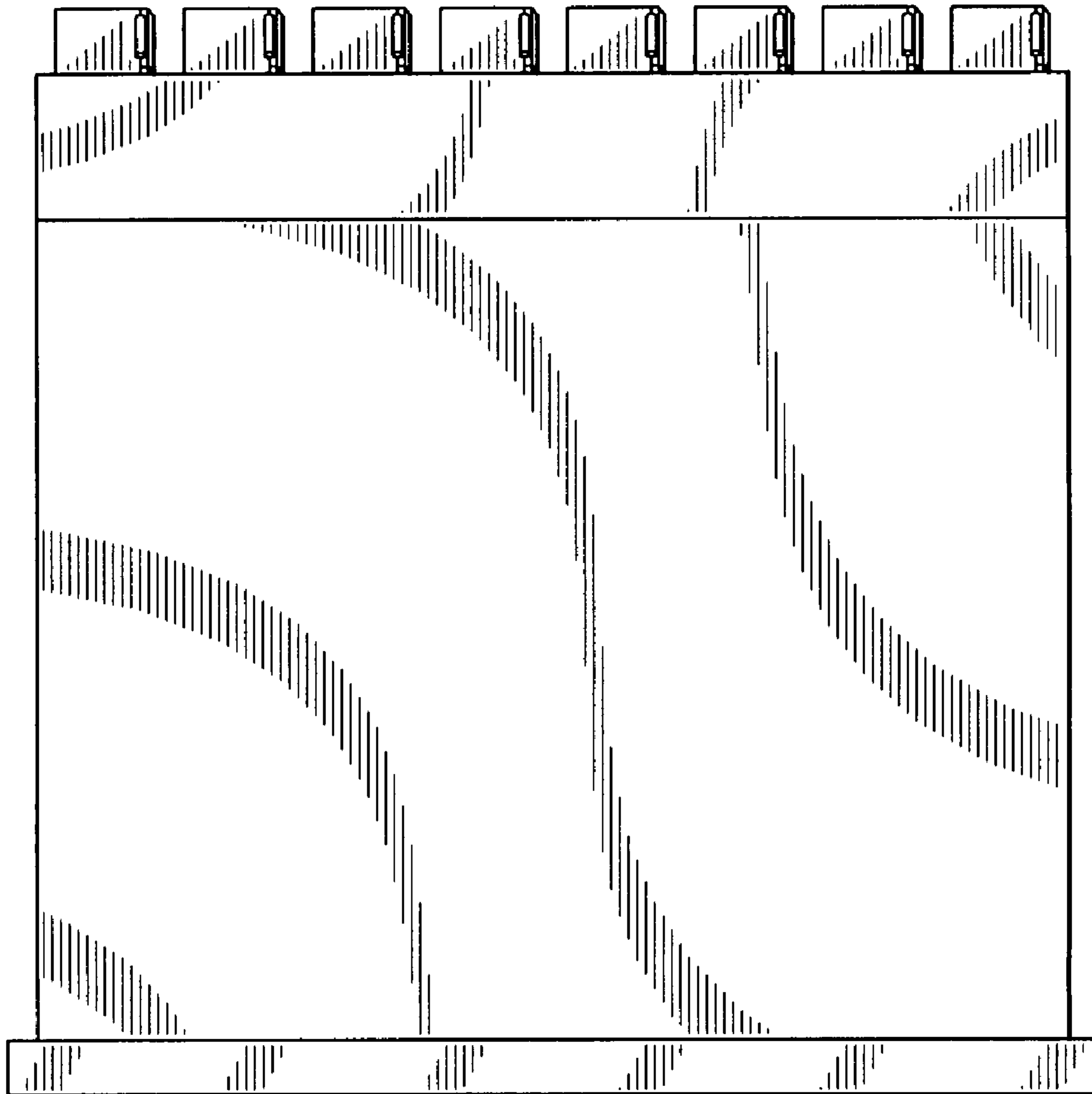

FIG. 10

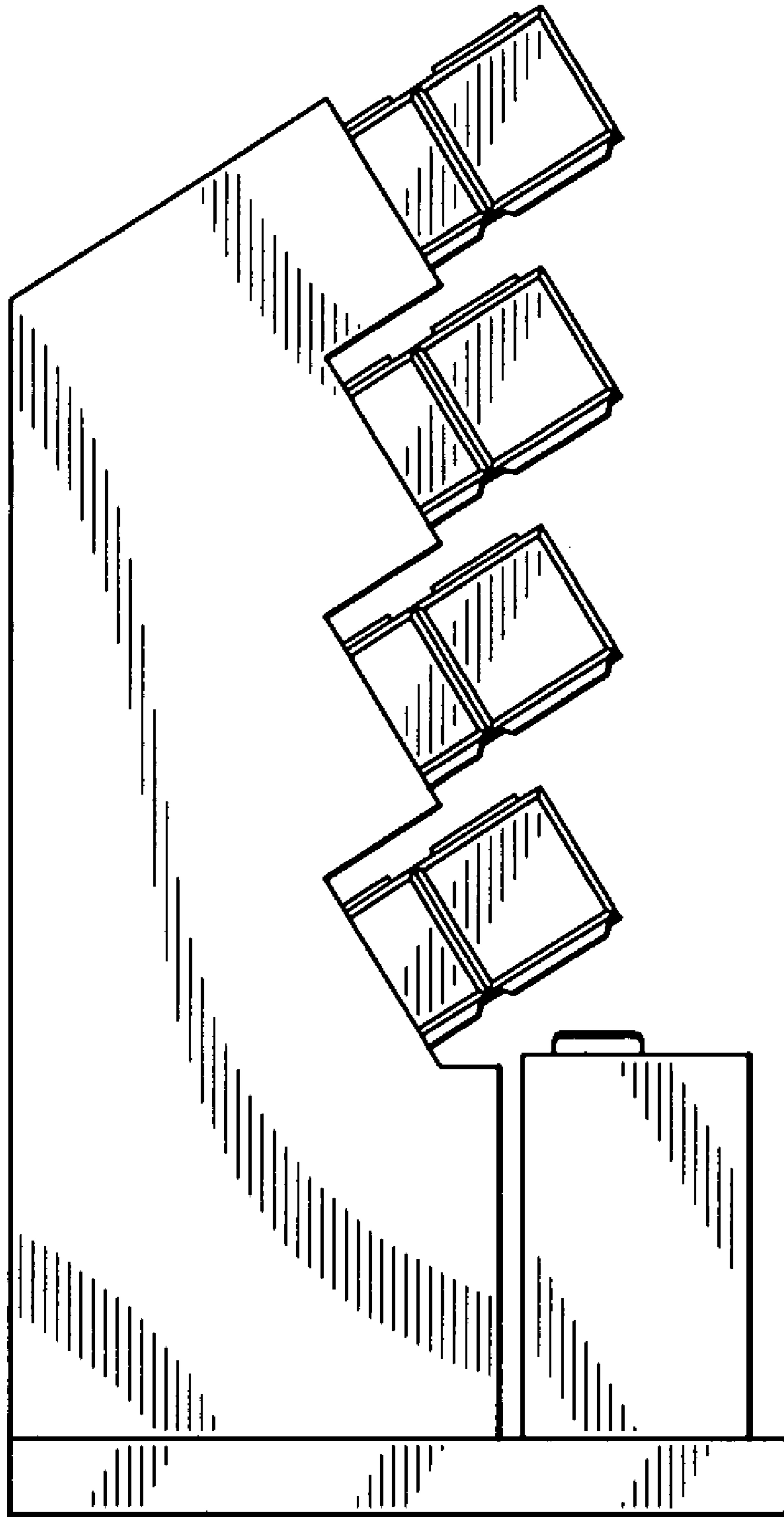

FIG. 11

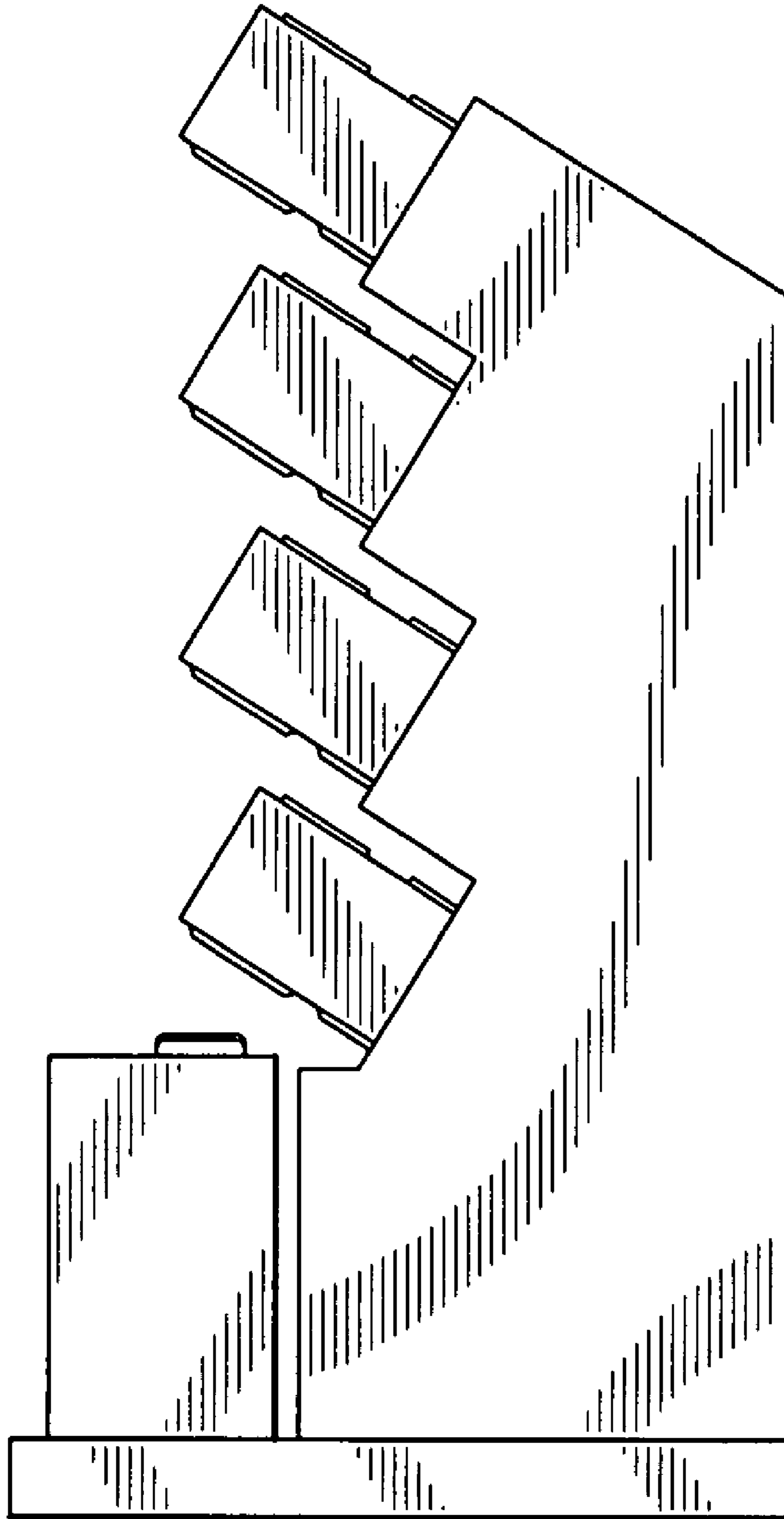

FIG. 12

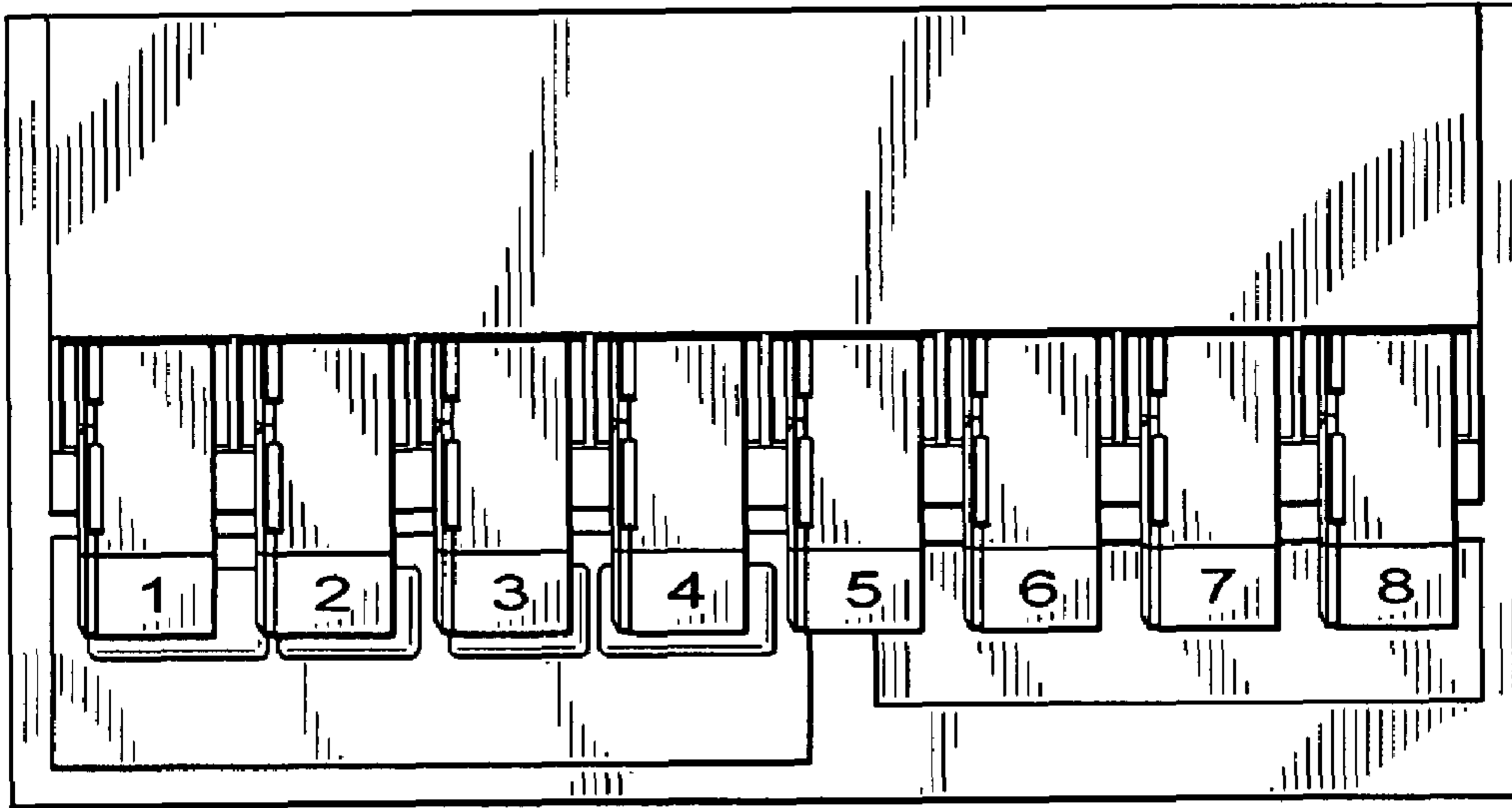

FIG. 13

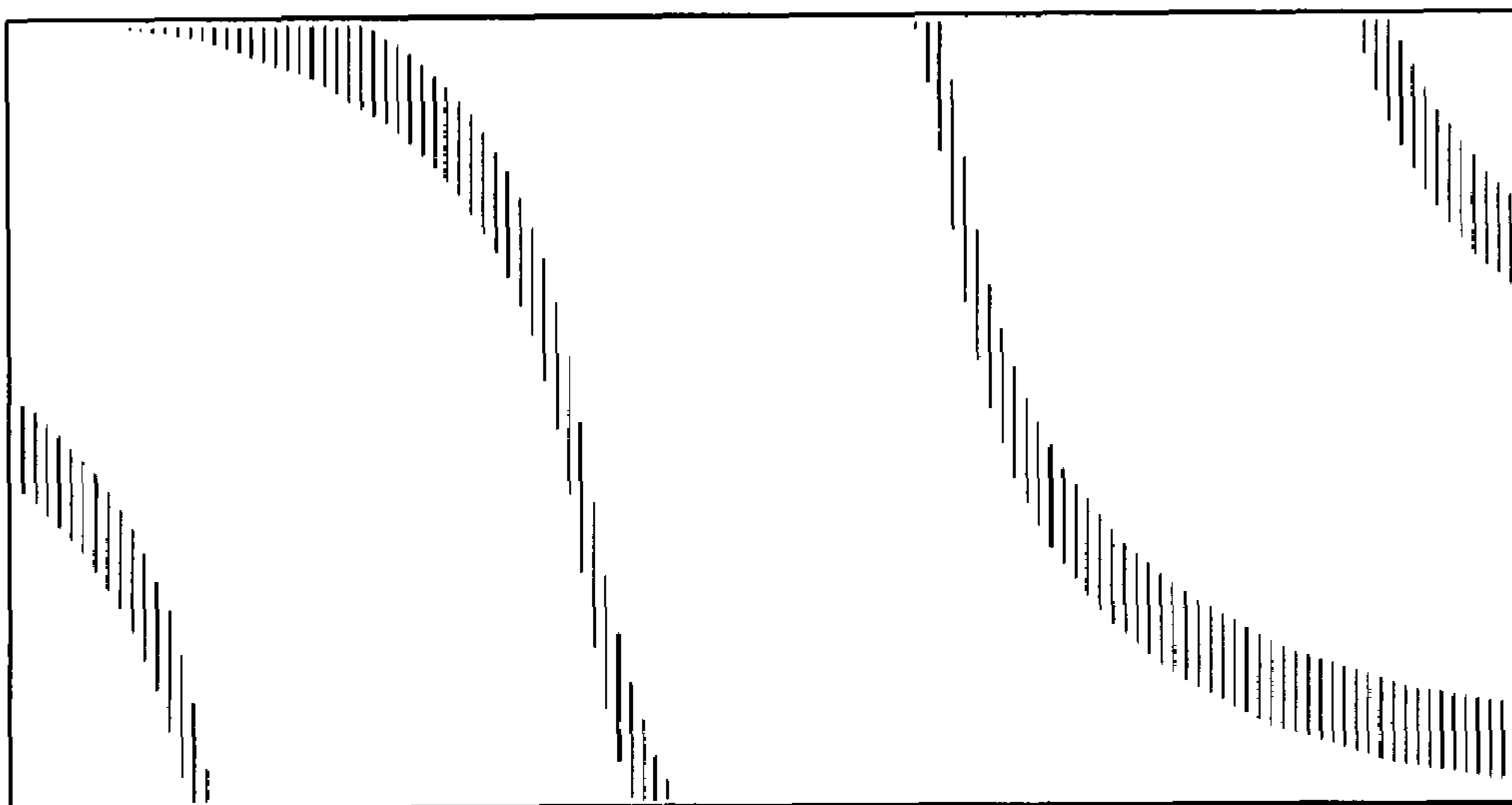

FIG. 14