



US00D576204S

(12) **United States Design Patent**
Aznoe et al.

(10) **Patent No.:** **US D576,204 S**
(45) **Date of Patent:** **** Sep. 2, 2008**

(54) **INK STICK FOR A PHASE CHANGE INK JET PRINTER**

(75) Inventors: **Brian Walter Aznoe**, Sherwood, OR (US); **Brent Rodney Jones**, Sherwood, OR (US)

(73) Assignee: **Xerox Corporation**, Norwalk, CT (US)

(**) Term: **14 Years**

(21) Appl. No.: **29/282,375**

(22) Filed: **Jul. 18, 2007**

(51) **LOC (8) Cl.** **18-02**

(52) **U.S. Cl.** **D18/56; 347/88**

(58) **Field of Classification Search** D18/56; 347/88, 99; 106/31.29, 31.61

See application file for complete search history.

(56) **References Cited**

U.S. PATENT DOCUMENTS

D412,527 S *	8/1999	Ellers et al.	D18/56
D412,528 S *	8/1999	Ellers et al.	D18/56
6,722,764 B2 *	4/2004	Jones et al.	347/88
D500,516 S *	1/2005	Jones et al.	D18/56
D500,785 S *	1/2005	Jones et al.	D18/56
6,893,121 B2 *	5/2005	Jones	347/88
6,986,570 B2 *	1/2006	Jones et al.	347/88
D518,097 S *	3/2006	Jones	D18/56
D520,559 S *	5/2006	Jones	D18/56
D521,064 S *	5/2006	Jones et al.	D18/56
D521,065 S *	5/2006	Jones et al.	D18/56
D524,854 S *	7/2006	Jones et al.	D18/56
D526,011 S *	8/2006	Jones et al.	D18/56

D528,159 S *	9/2006	Jones	D18/56
D537,116 S *	2/2007	Jones et al.	D18/56
D566,171 S *	4/2008	Korn et al.	D18/56
D569,419 S *	5/2008	Korn et al.	D18/56
D570,406 S *	6/2008	Korn et al.	D18/56
D570,407 S *	6/2008	Korn et al.	D18/56
2003/0202071 A1 *	10/2003	Jones et al.	347/88
2004/0179074 A1 *	9/2004	Jones et al.	347/99
2004/0201657 A1 *	10/2004	Jones et al.	347/99
2006/0279617 A1 *	12/2006	Korn et al.	347/88

* cited by examiner

Primary Examiner—Cathy Anne MacCormac
(74) *Attorney, Agent, or Firm*—Tallam I. Nguti

(57) **CLAIM**

The ornamental design for an ink stick for a phase change ink jet printer, as shown.

DESCRIPTION

FIG. 1 is a perspective view of an ink stick for a phase change ink jet printer illustrating the new design;

FIG. 2 is a front elevational view thereof;

FIG. 3 is a right side elevational view thereof;

FIG. 4 is a rear elevational view thereof;

FIG. 5 is a left side elevational view thereof;

FIG. 6 is a top plan view thereof; and,

FIG. 7 is a bottom plan view thereof.

The broken lines are for purposes of illustration only and form no part of the claimed design.

1 Claim, 5 Drawing Sheets

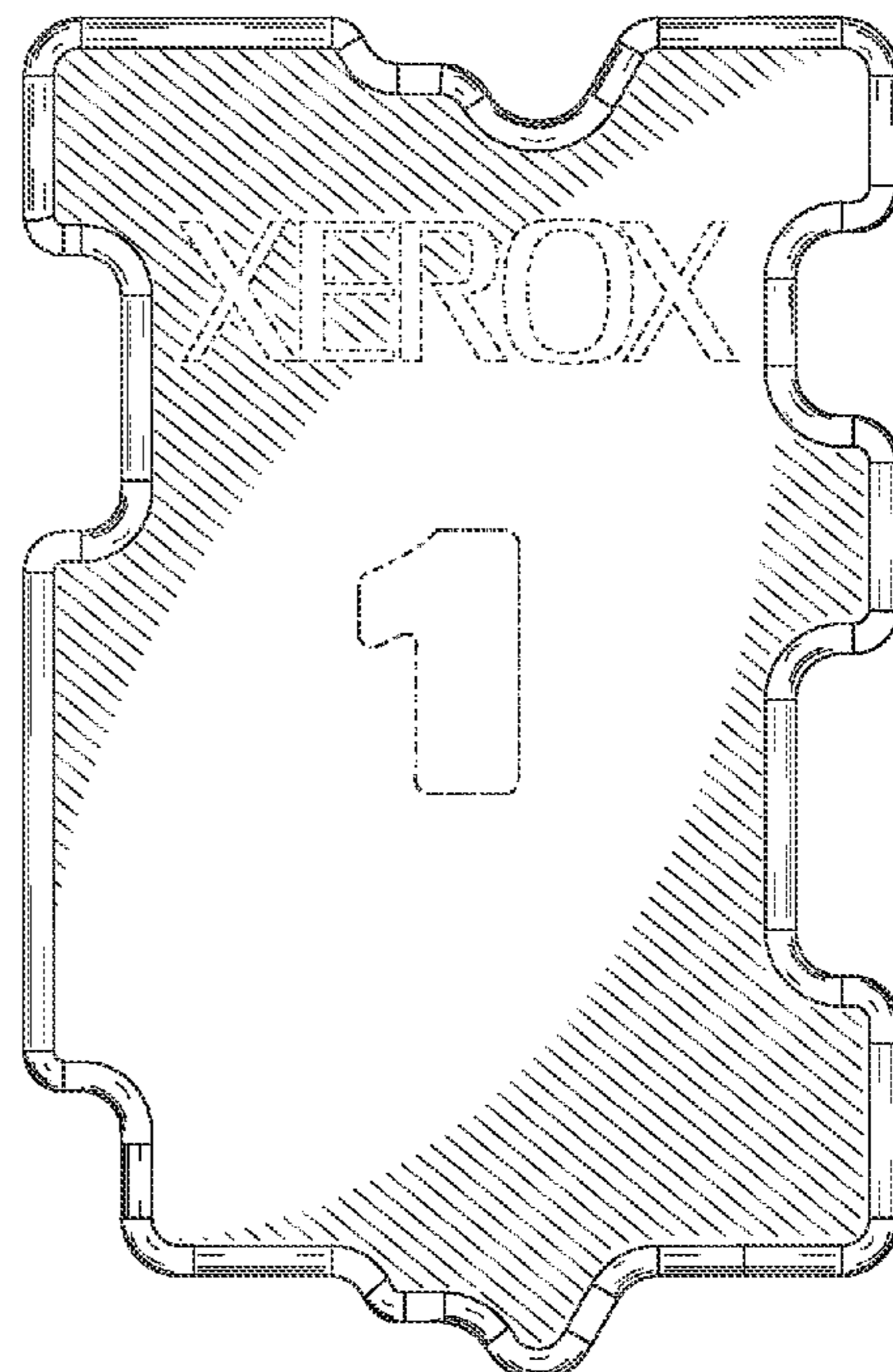
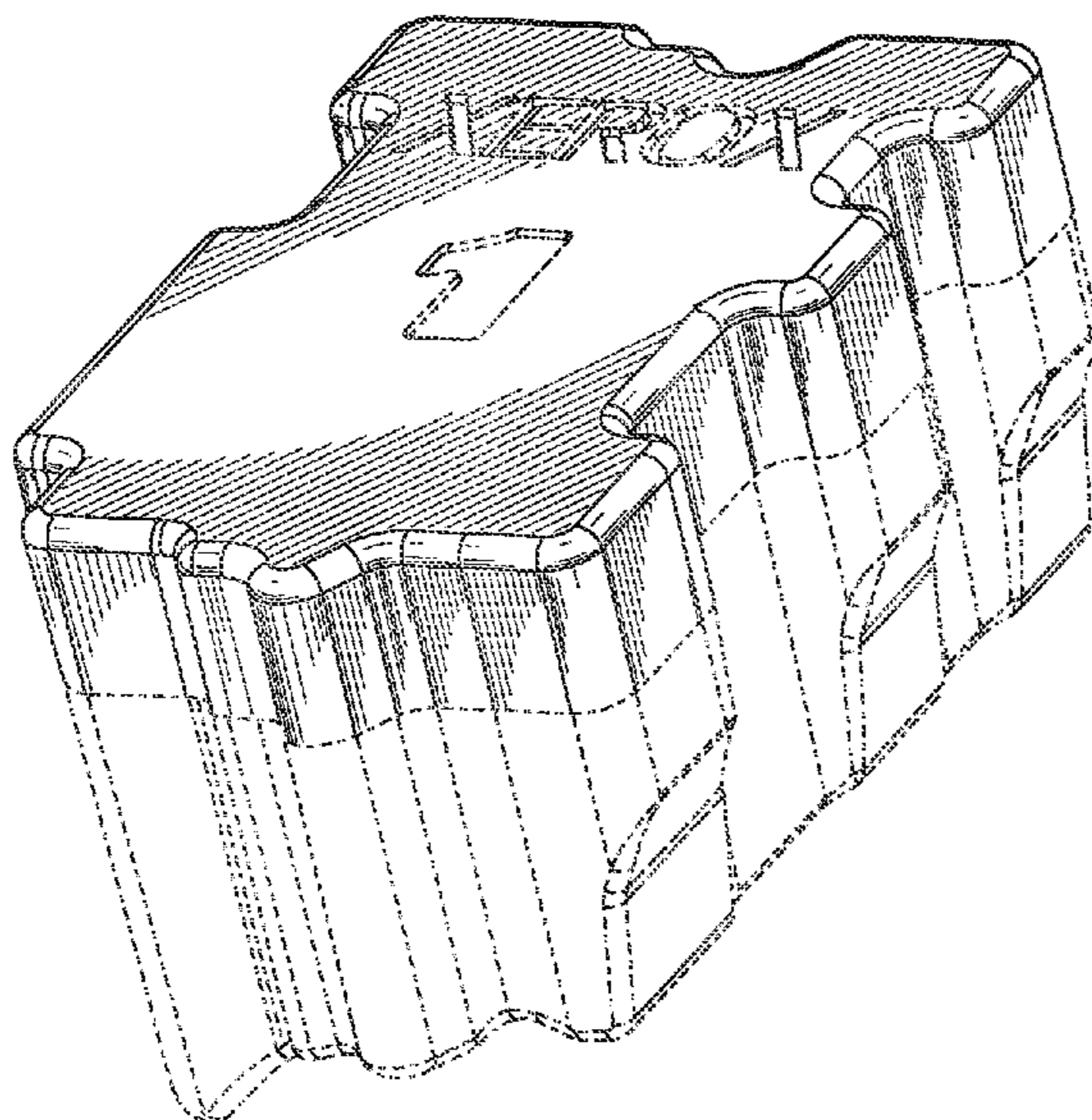

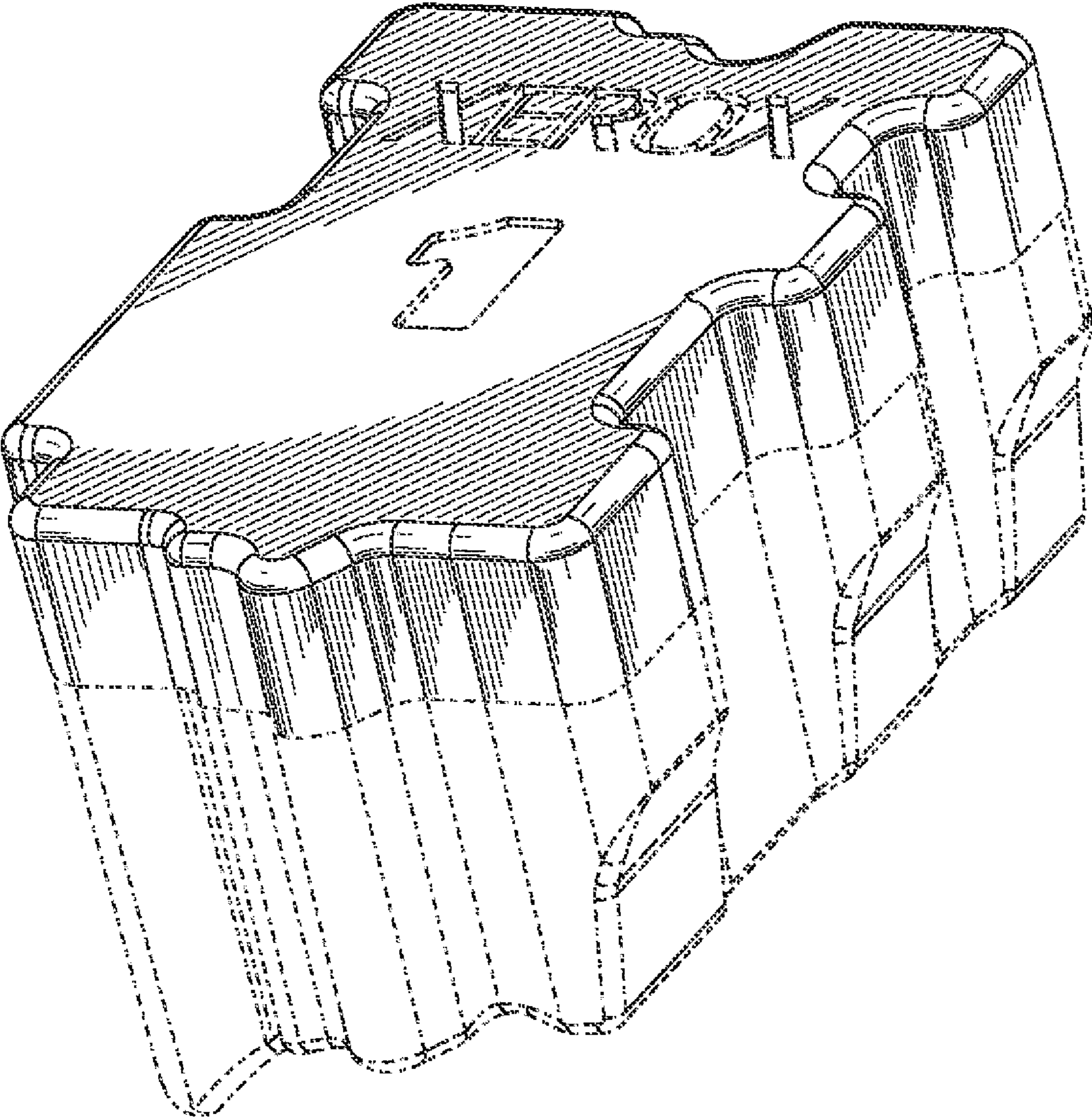

FIG. 1

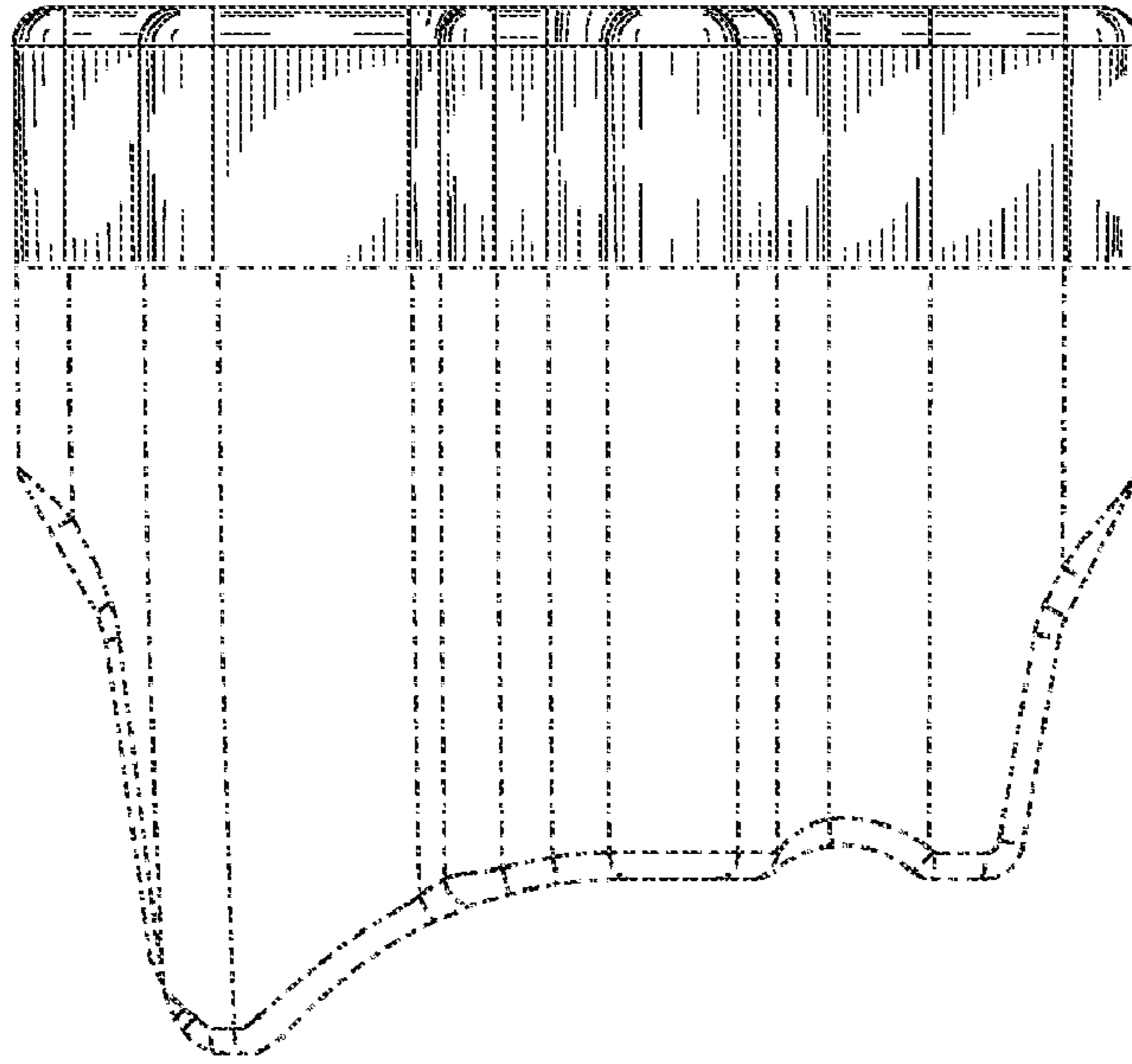

FIG. 2

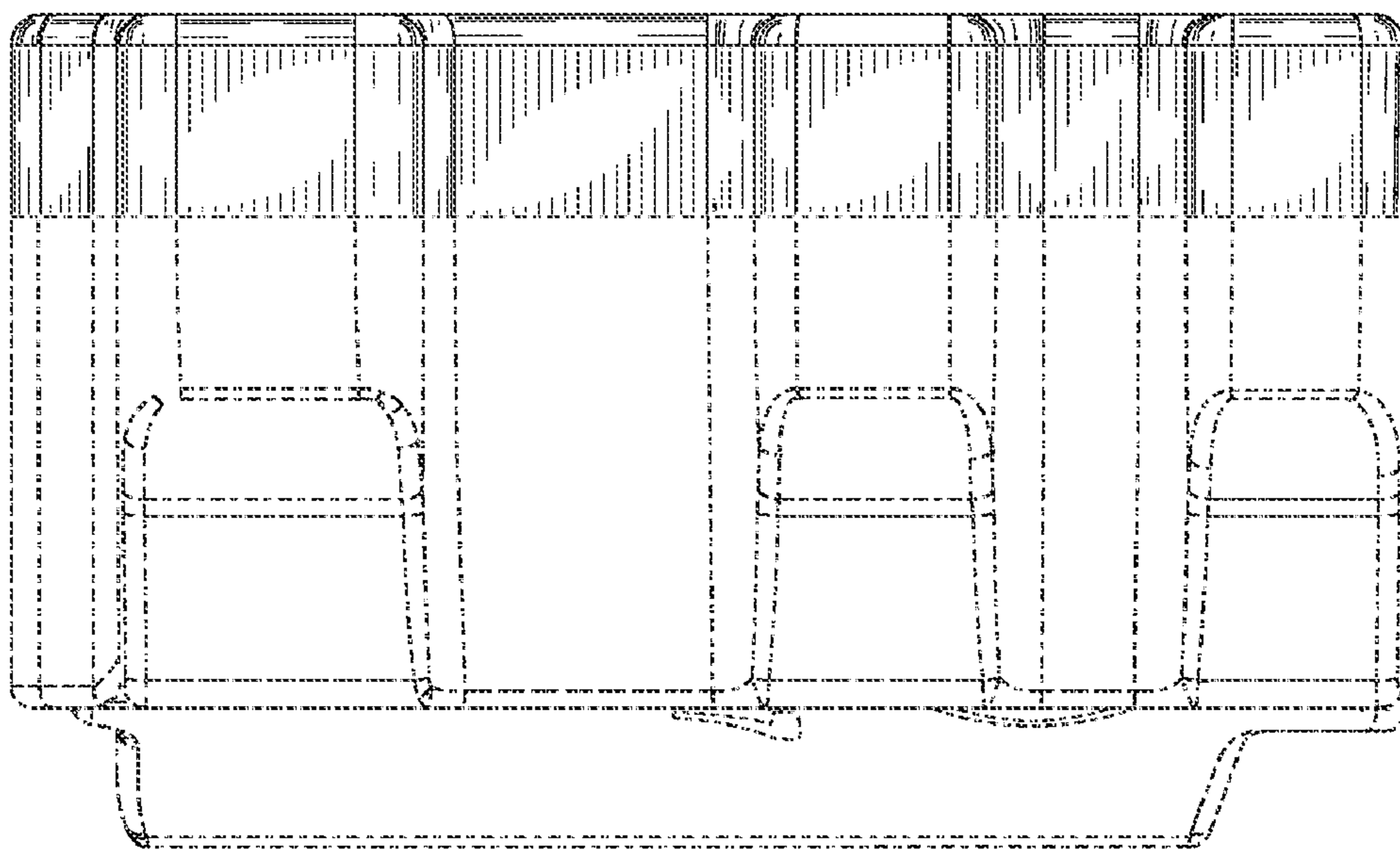

FIG. 3

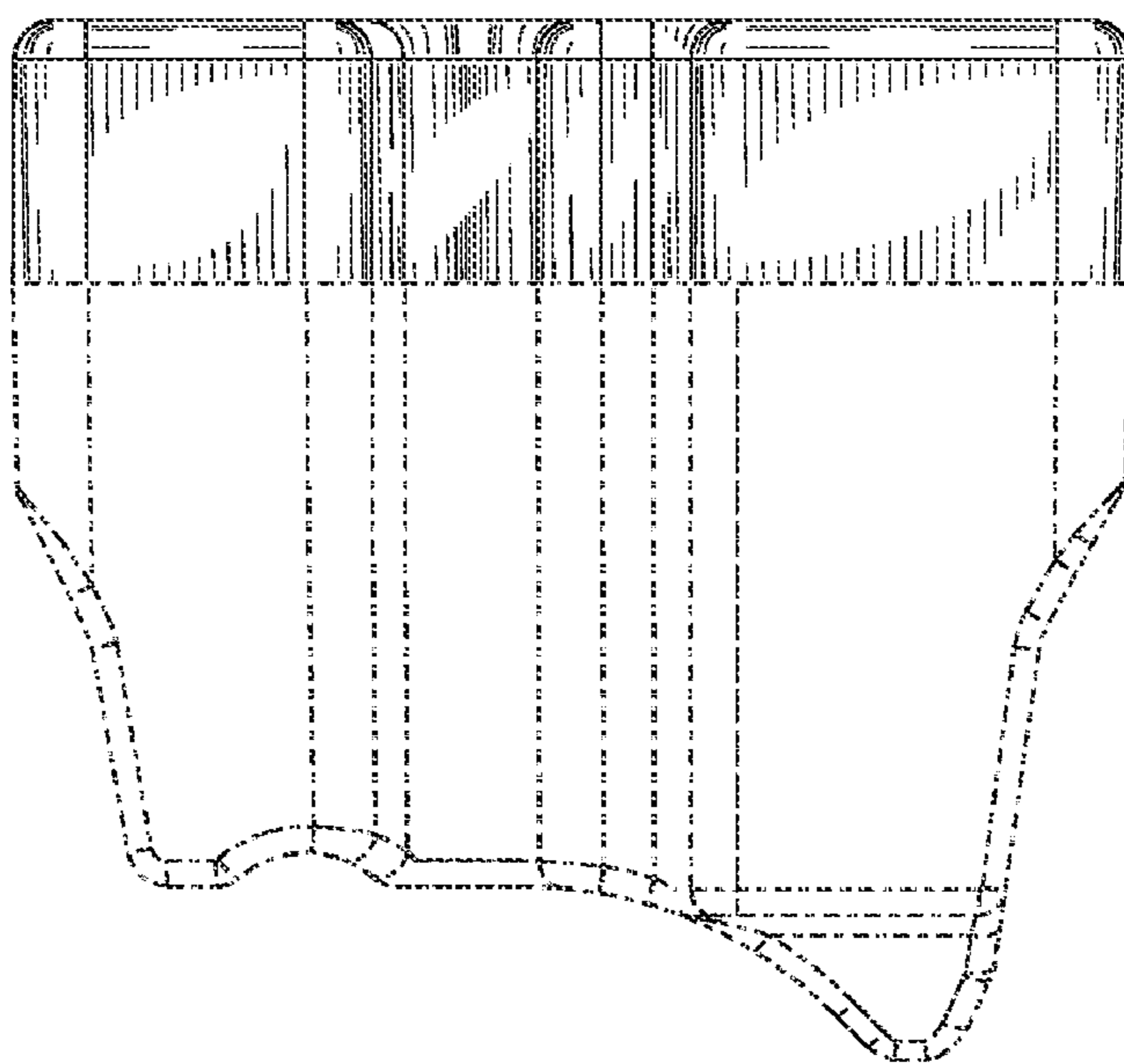

FIG. 4

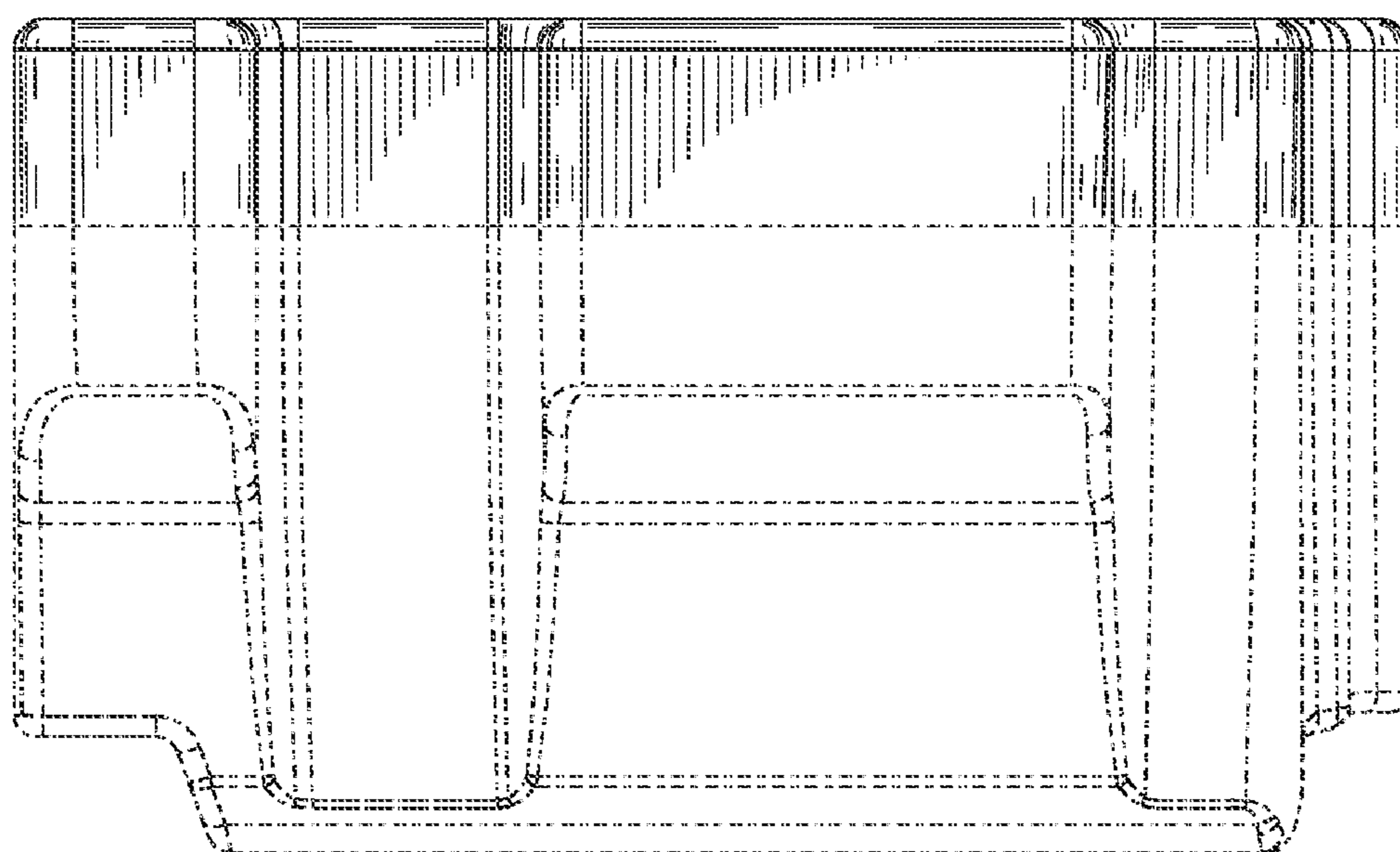

FIG. 5

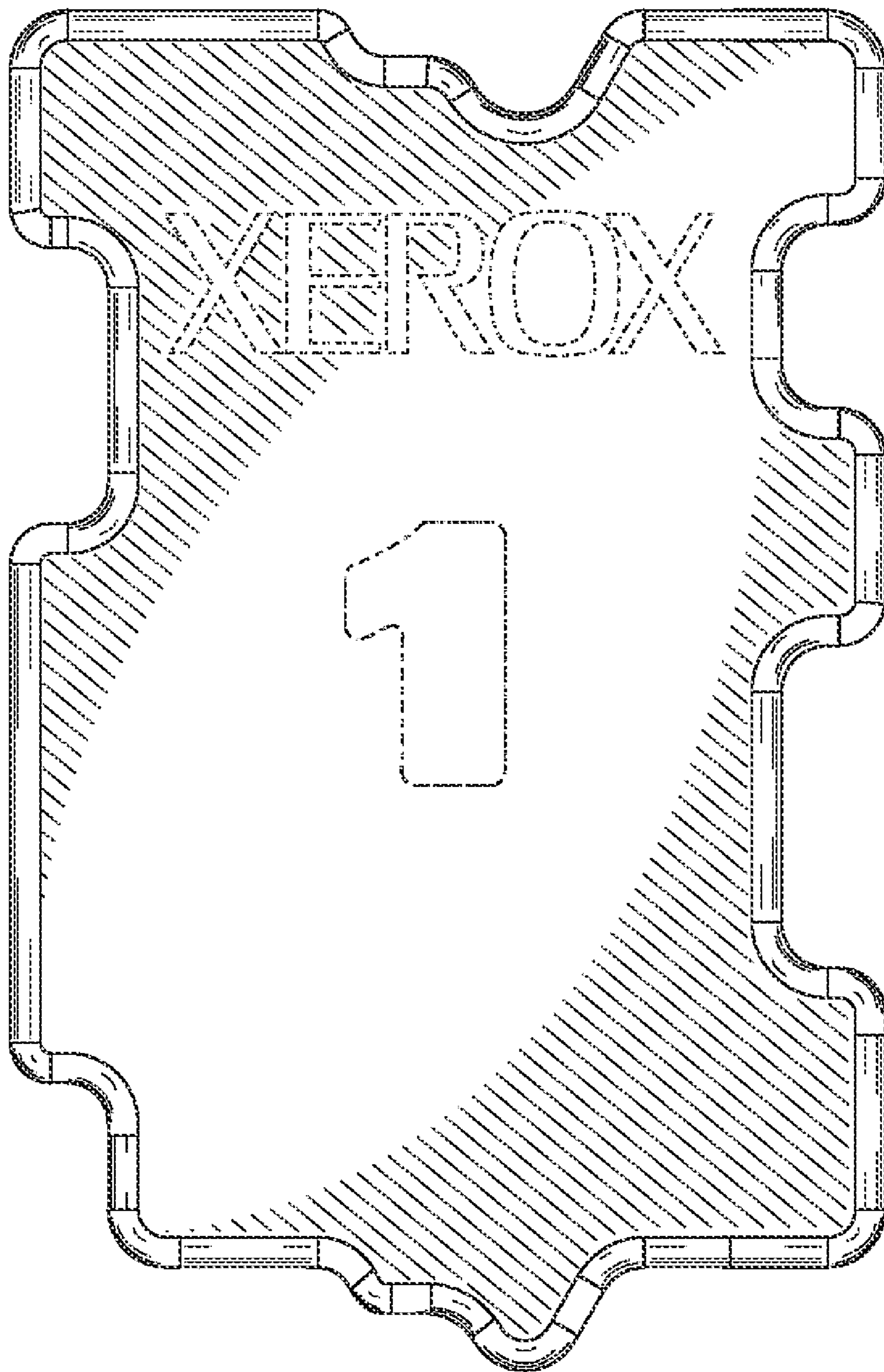

FIG. 6

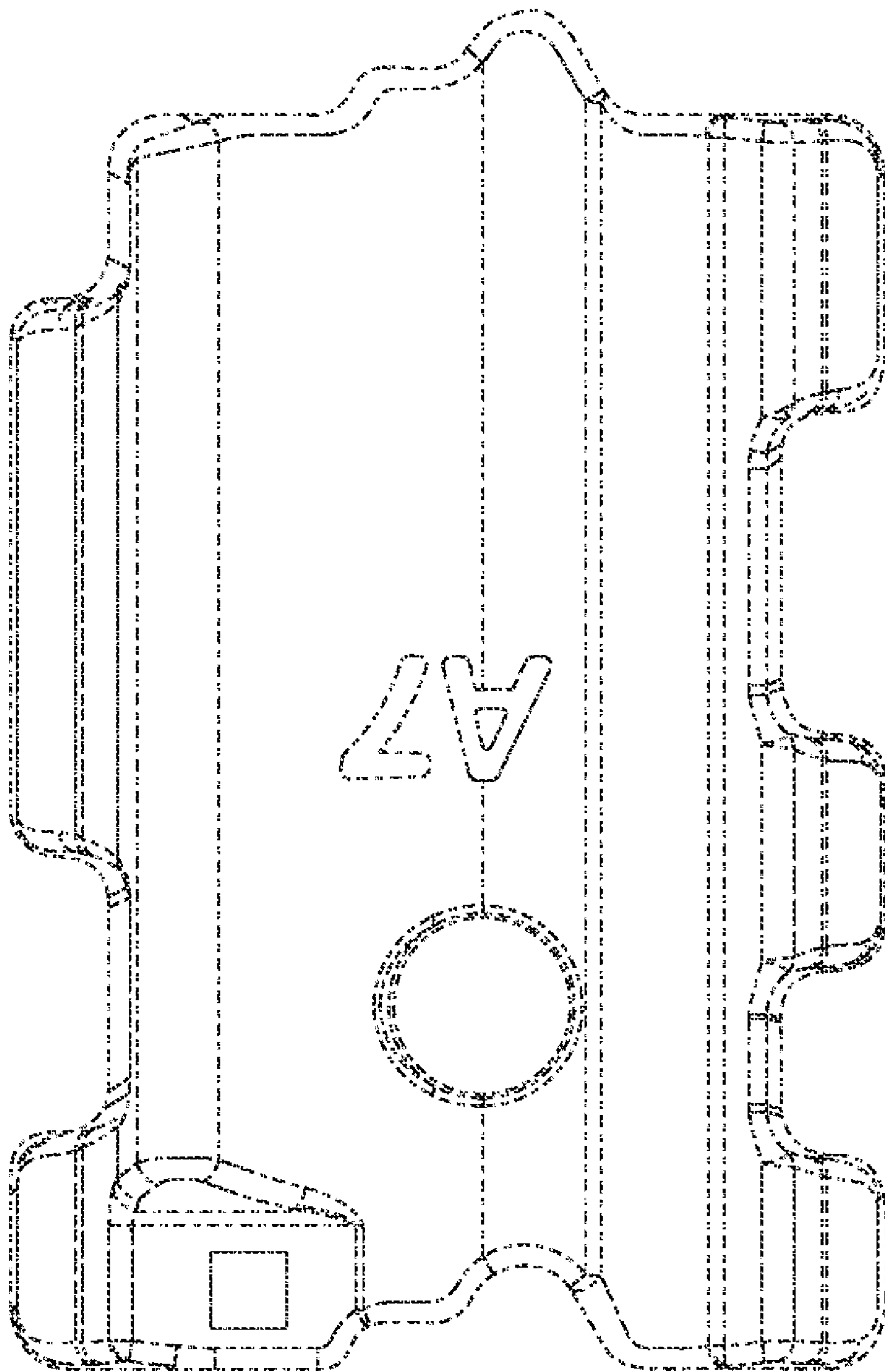

FIG. 7