



US00D576142S

(12) **United States Design Patent**
Park et al.

(10) **Patent No.:** **US D576,142 S**
(45) **Date of Patent:** **** Sep. 2, 2008**

(54) **MOBILE PHONE**

(75) Inventors: **Dae Yoeb Park**, Seoul (KR); **Nam Mi Kim**, Seoul (KR); **Chang Soo Lee**, Seoul (KR)

(73) Assignee: **Samsung Electronics Co., Ltd.**, Suwon (KR)

(**) Term: **14 Years**

(21) Appl. No.: **29/292,313**

(22) Filed: **Oct. 5, 2007**

(51) **LOC (8) Cl.** **14-03**

(52) **U.S. Cl.** **D14/138**

(58) **Field of Classification Search** D14/138,
D14/496, 341–347; 455/575.3, 575.1; D21/517
See application file for complete search history.

(56) **References Cited**

U.S. PATENT DOCUMENTS

D491,905 S *	6/2004	Jang	D14/138
D498,468 S *	11/2004	Seo	D14/138
D501,458 S *	2/2005	Kim et al.	D14/138
D509,816 S *	9/2005	Kim et al.	D14/138
D512,398 S *	12/2005	Chen et al.	D14/138
D521,968 S *	5/2006	Jung et al.	D14/138
D537,426 S *	2/2007	Arbisi	D14/138
7,269,443 B2 *	9/2007	Park et al.	455/556.2
D554,093 S *	10/2007	Arnholt et al.	D14/138
D558,170 S *	12/2007	Wang et al.	D14/138
D559,216 S *	1/2008	Sheu et al.	D14/138
D559,814 S *	1/2008	Kim et al.	D14/138
D559,825 S *	1/2008	Park et al.	D14/138
D560,643 S *	1/2008	Kim et al.	D14/138
D561,719 S *	2/2008	Cho et al.	D14/138
D561,726 S *	2/2008	Hong et al.	D14/138
D563,924 S *	3/2008	Arnold et al.	D14/138
D564,480 S *	3/2008	Linares et al.	D14/138
D565,006 S *	3/2008	Griffin et al.	D14/138

2006/0019728 A1 *	1/2006	Sakamoto et al.	455/575.3
2006/0135226 A1 *	6/2006	Won et al.	455/575.3
2006/0148542 A1 *	7/2006	Oliver	455/575.3
2007/0281759 A1 *	12/2007	Choi	455/575.1

OTHER PUBLICATIONS

Samsung C250 telephone, announced Feb. 2007, [online], [site visited Apr. 22, 2008]. Available from Internet ,<URL: <http://www.gsmarena.com>>.*

Samsung X680 telephone, announced 2nd quarter 2006, [online], [site visited Apr. 22, 2008]. Available from Internet ,<URL: <http://www.gsmarena.com>>.*

Samsung P850 telephone, announced 1st quarter 2005, [online], [site visited Apr. 22, 2008]. Available from Internet ,<URL: <http://www.gsmarena.com>>.*

Samsung A500 telephone, announced 2002, [online], [site visited Apr. 22, 2008]. Available from Internet ,<URL: <http://www.gsmarena.com>>.*

(Continued)

Primary Examiner—Jeffrey D Asch

(74) *Attorney, Agent, or Firm*—Ladas and Parry LLP

(57) **CLAIM**

We claim the ornamental design for mobile phone, as shown.

DESCRIPTION

FIG. 1 is a front/left-side/top perspective view of a mobile phone showing our new design;

FIG. 2 is a front-side elevational view thereof;

FIG. 3 is a rear-side elevational view thereof;

FIG. 4 is a left-side elevational view thereof;

FIG. 5 is a right-side elevational view thereof;

FIG. 6 is a top-side elevational view thereof;

FIG. 7 is a bottom-side elevational view thereof; and,

FIG. 8 is a front/left-side/top perspective view thereof showing the folder is opened.

1 Claim, 7 Drawing Sheets

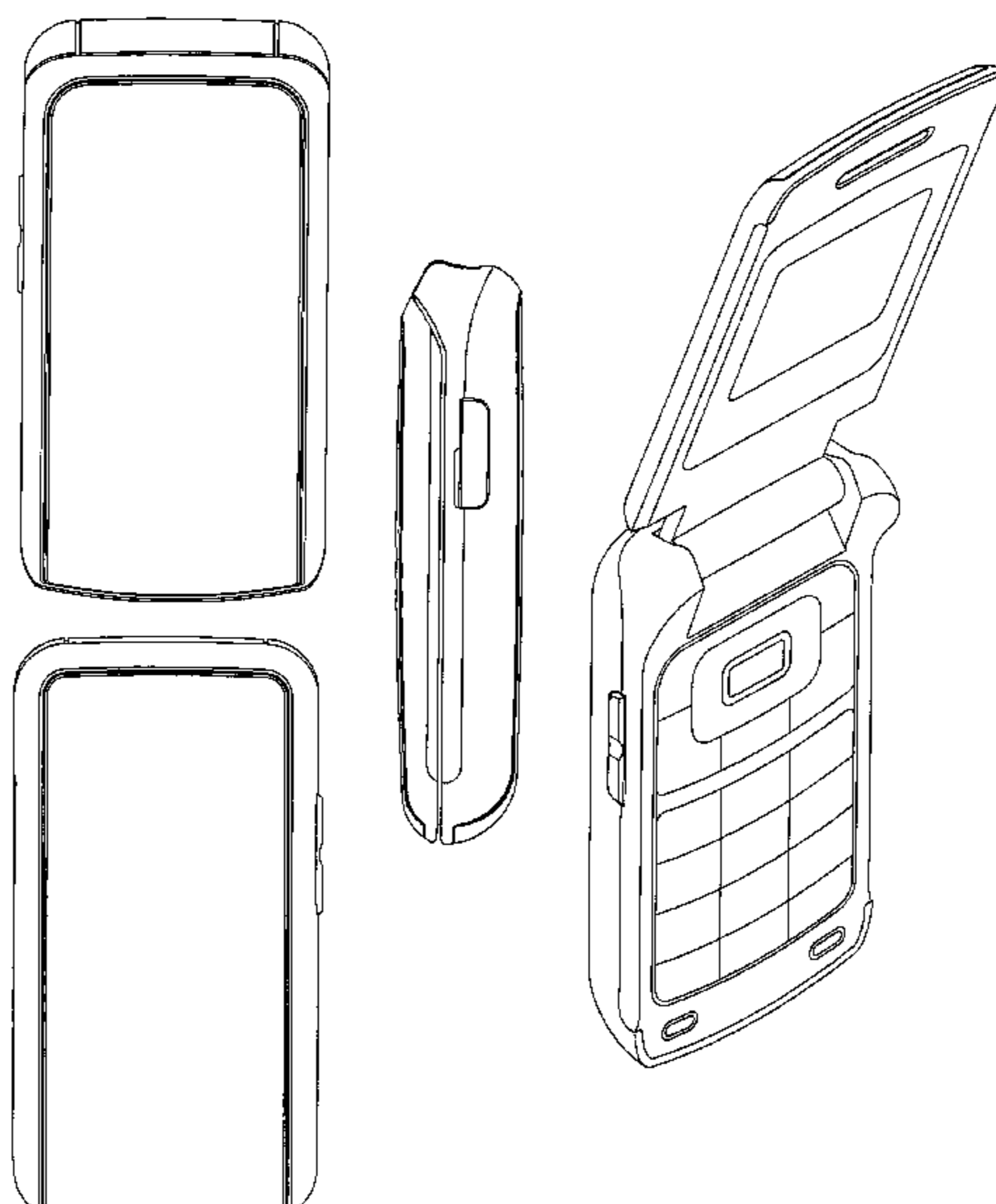

OTHER PUBLICATIONS

LG KF300 telephone, announced Apr. 2008, [online], [site visited Apr. 22, 2008]. Available from Internet ,<URL: <http://www.gsmarena.com>>.*

Sagem my411c telephone, announced Feb. 2008, [online], [site visited Apr. 22, 2008]. Available from Internet ,<URL: <http://www.gsmarena.com>>.*

Alcatel OT-E230 telephone, announced Feb. 2007, [online], [site visited Apr. 22, 2008]. Available from Internet ,<URL: <http://www.gsmarena.com>>.*

Philips Xenium 9@9s telephone, announced Sep. 2006, [online], [site visited Apr. 22, 2008]. Available from Internet, <URL: <http://www.gsmarena.com>>.*

* cited by examiner

FIG. 1

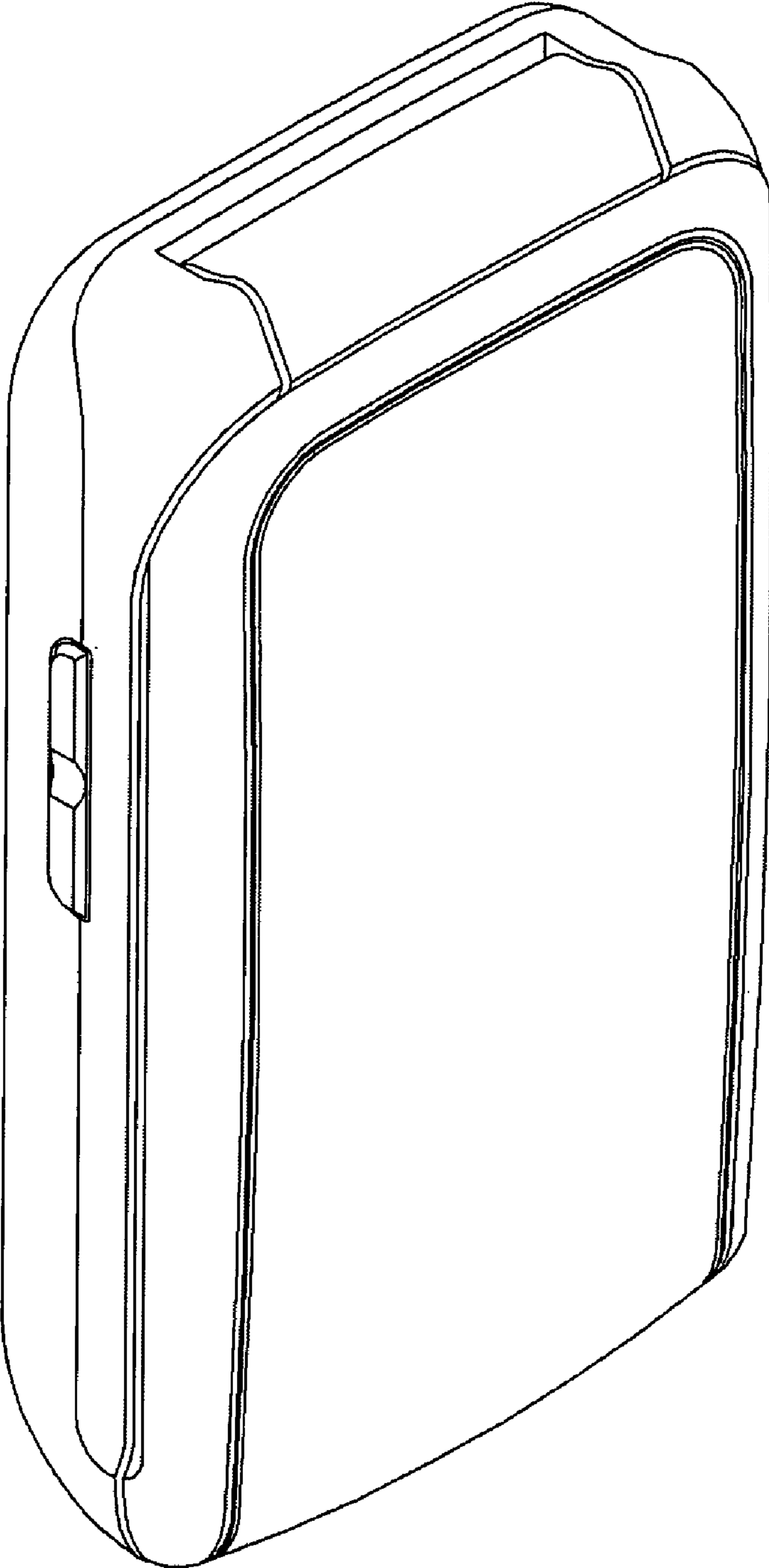

FIG. 2

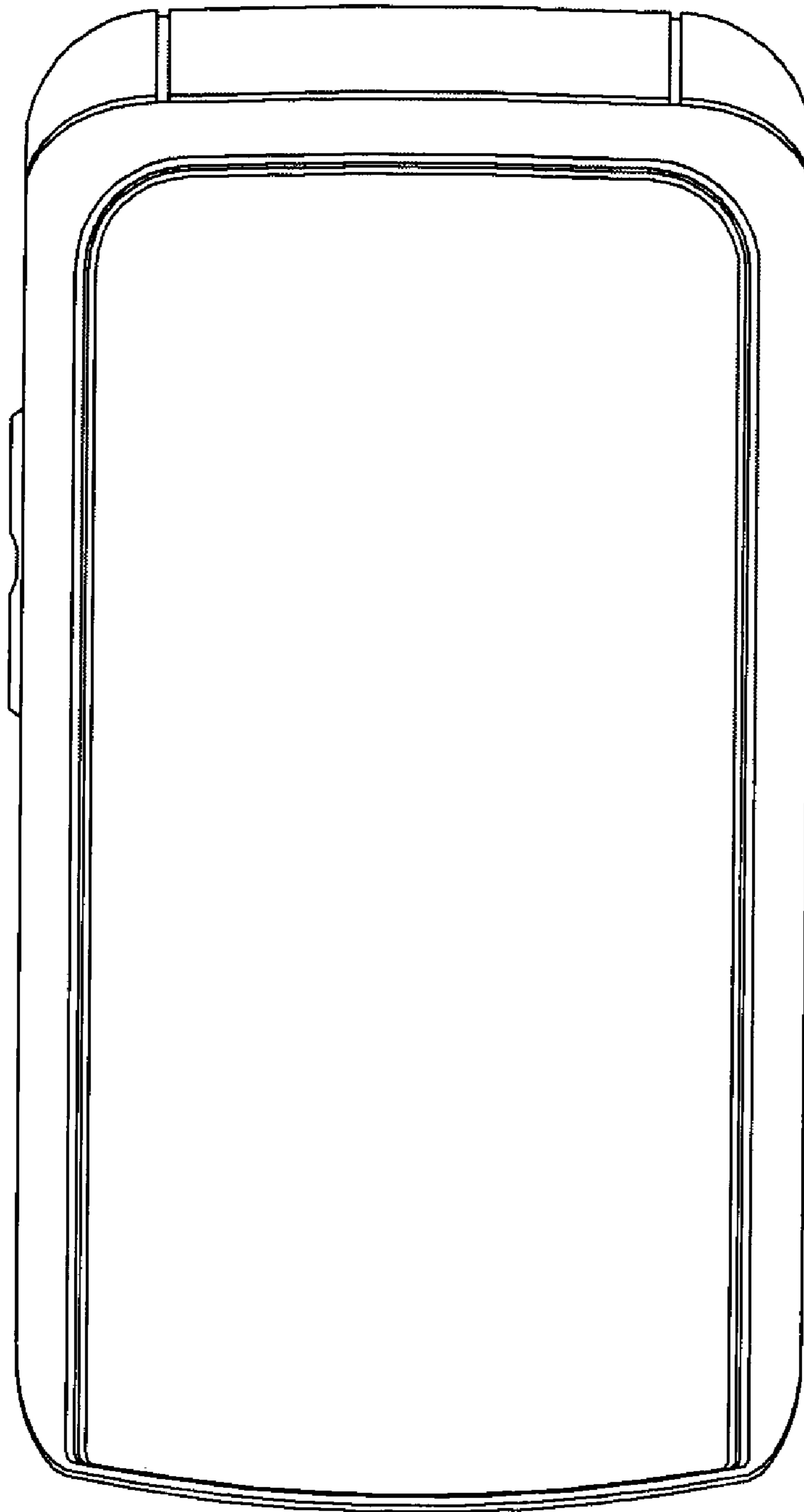

FIG. 3

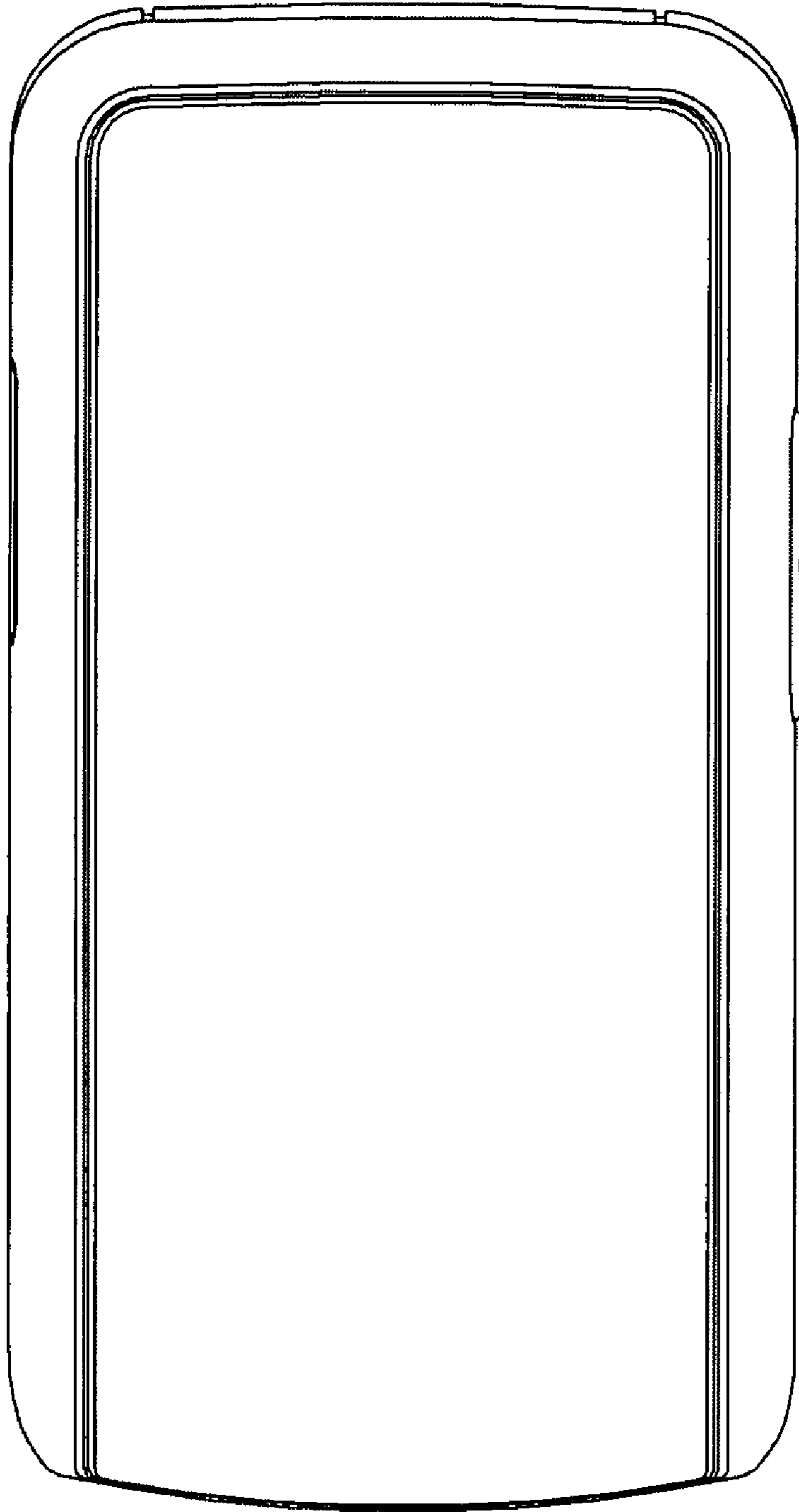

FIG. 4

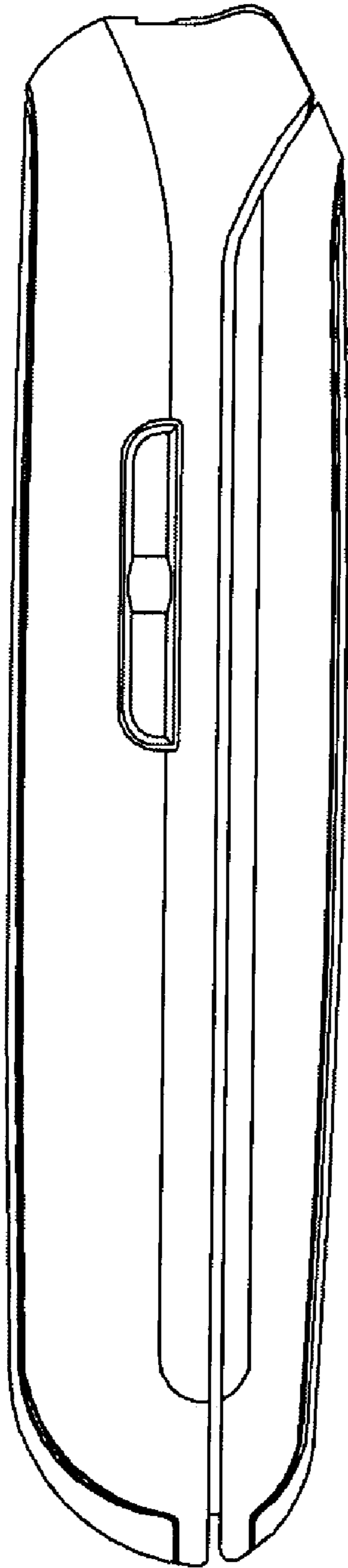

FIG. 5

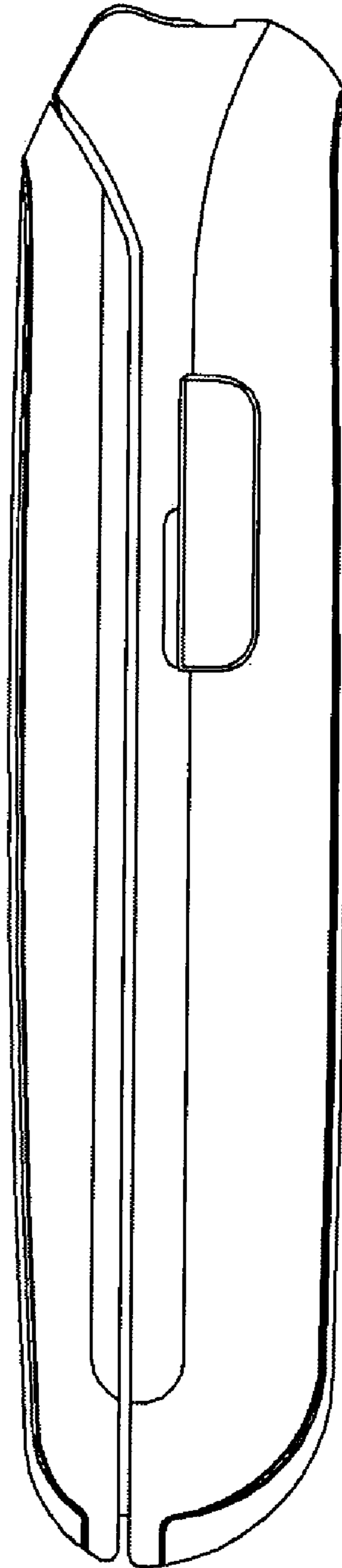

FIG. 6

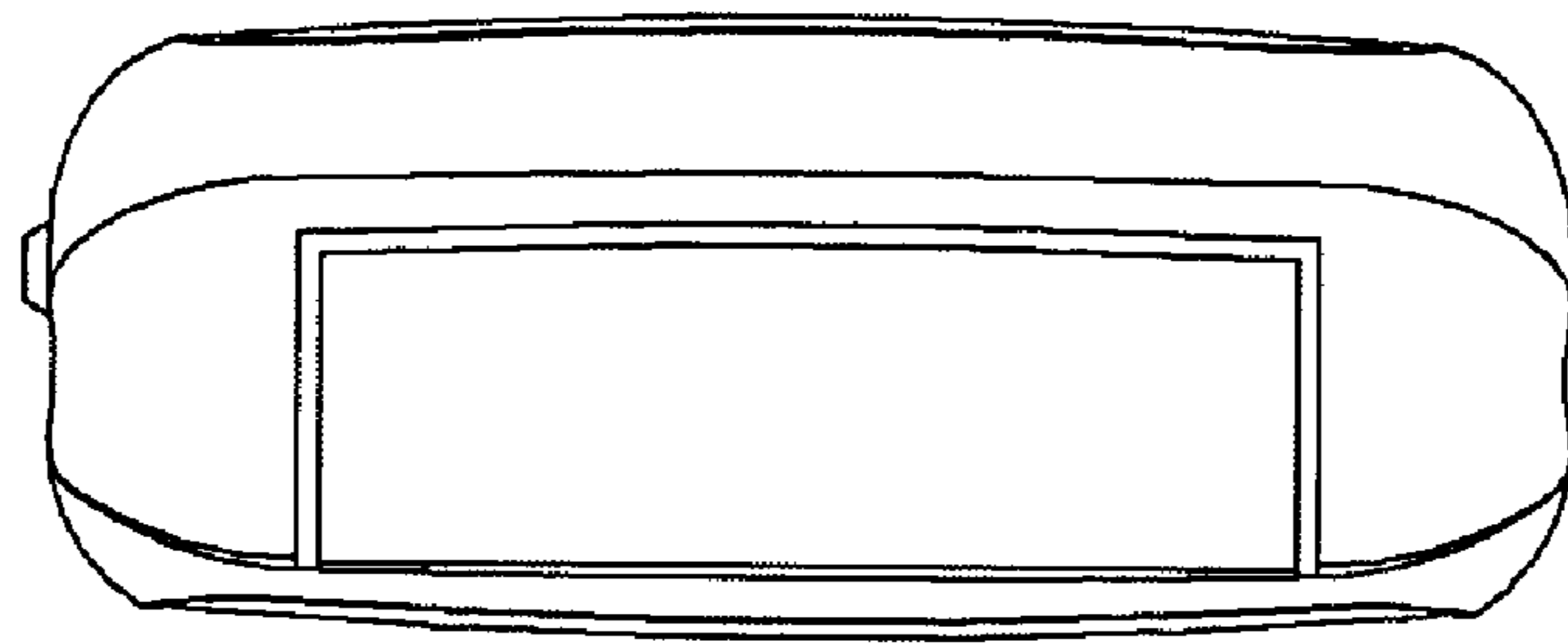

FIG. 7

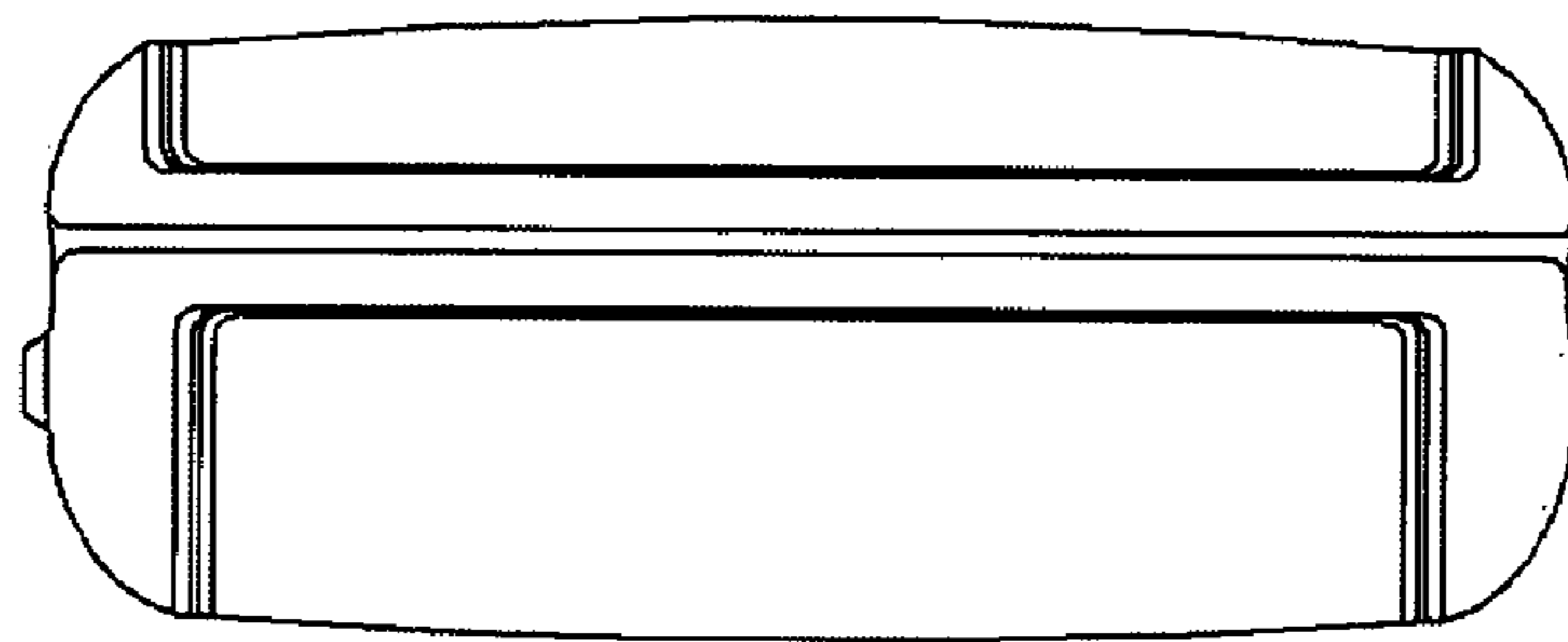

FIG. 8

