



US00D576048S

(12) **United States Design Patent**
Lepoitevin

(10) **Patent No.:** **US D576,048 S**

(45) **Date of Patent:** **** Sep. 2, 2008**

(54) **BOTTLE**

(75) Inventor: **Laurent Lepoitevin**, Le Havre Cedex
(FR)

(73) Assignee: **Sidel Participations** (FR)

(**) Term: **14 Years**

(21) Appl. No.: **29/290,211**

(22) Filed: **Nov. 5, 2007**

(30) **Foreign Application Priority Data**

May 29, 2007 (EM) 000730692

(51) **LOC (8) Cl.** **09-01**

(52) **U.S. Cl.** **D9/548; D9/549**

(58) **Field of Classification Search** D9/516,
D9/519, 520, 522, 529, 537, 538, 540-543,
D9/544, 545, 546, 548, 549, 551, 552, 556,
D9/557, 558, 559, 560, 564, 565, 569, 570,
D9/574, 575; 215/381-385, 396, 398

See application file for complete search history.

(56) **References Cited**

U.S. PATENT DOCUMENTS

D16,159 S *	7/1885	Atterbury	D9/545
D154,481 S *	7/1949	High	D9/559
D156,957 S *	1/1950	High	D9/551
D182,107 S *	2/1958	Colonma de Giovellina	.	D9/526
D187,960 S *	5/1960	Marins	D9/546
D249,329 S *	9/1978	Schacher et al.	D9/530
D280,707 S *	9/1985	Imanishi	D9/519
D284,837 S *	7/1986	Nilsson	D9/503

D311,491 S *	10/1990	Bompard	D9/545
D318,614 S *	7/1991	Sheridan	D9/519
D341,321 S *	11/1993	De Silva	D9/519
D459,545 S *	6/2002	Choe et al.	D28/20
D509,742 S *	9/2005	Biondich et al.	D9/519
D531,907 S *	11/2006	Lepoitevin	D9/531
D532,307 S *	11/2006	Durand	D9/519
D535,886 S *	1/2007	Yourist et al.	D9/552
D545,680 S *	7/2007	Cha et al.	D9/519
D547,197 S *	7/2007	Hermel	D9/646
D550,095 S *	9/2007	De Oliveira Neto	D9/564
D554,507 S *	11/2007	Laupie	D9/519

* cited by examiner

Primary Examiner—Stella M. Reid

Assistant Examiner—Elizabeth J Oswecki

(74) *Attorney, Agent, or Firm*—McKenna Long & Aldridge
LLP

(57) **CLAIM**

The ornamental design for a bottle, as shown and described.

DESCRIPTION

FIG. 1 is a first perspective view of a bottle showing my new design;

FIG. 2 is a second perspective view thereof;

FIG. 3 is a first side elevation view thereof;

FIG. 4 is a second side elevation view thereof;

FIG. 5 is a third side elevation view thereof;

FIG. 6 is a top plan view thereof; and,

FIG. 7 is a bottom plan view thereof.

1 Claim, 6 Drawing Sheets

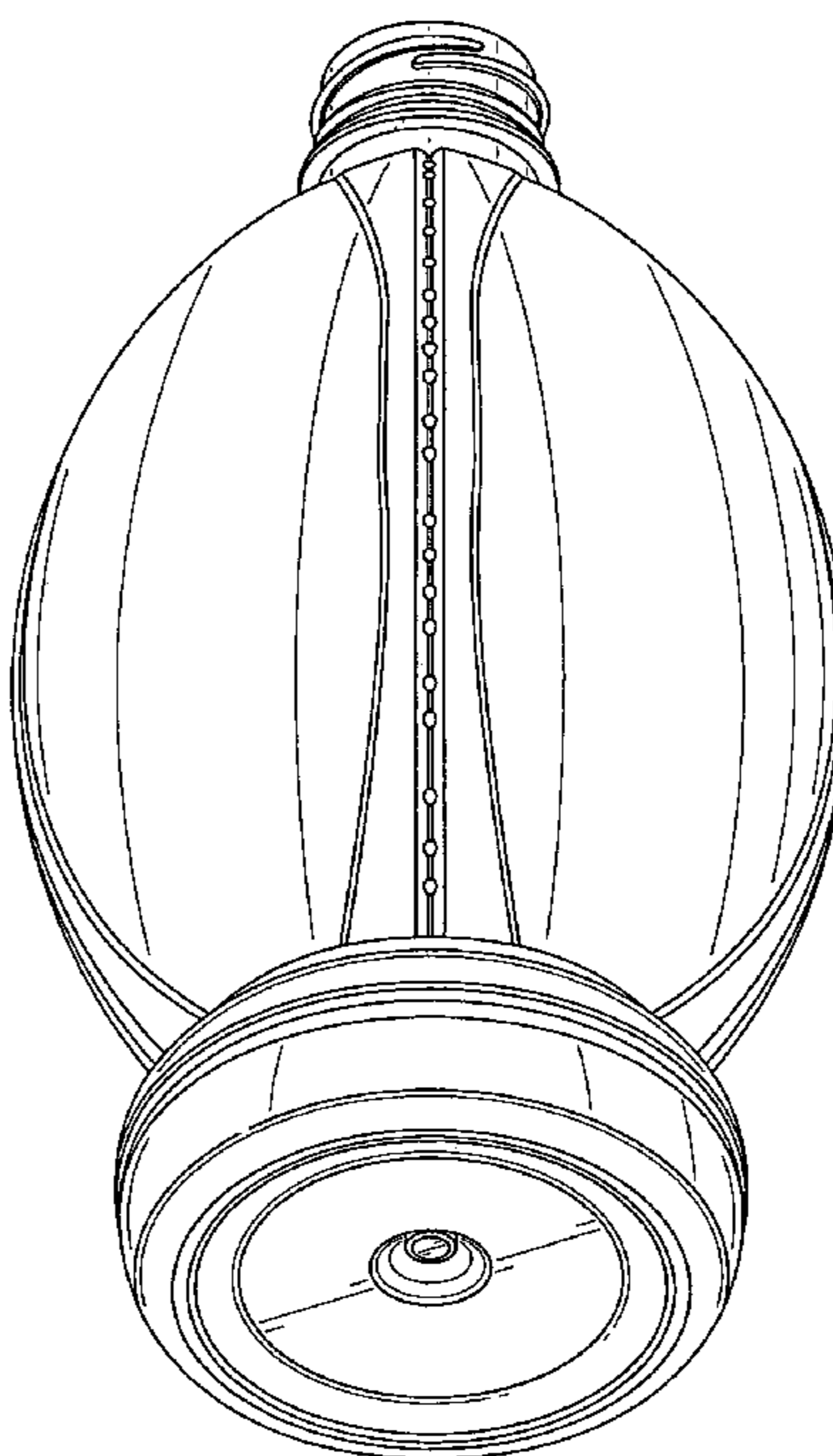
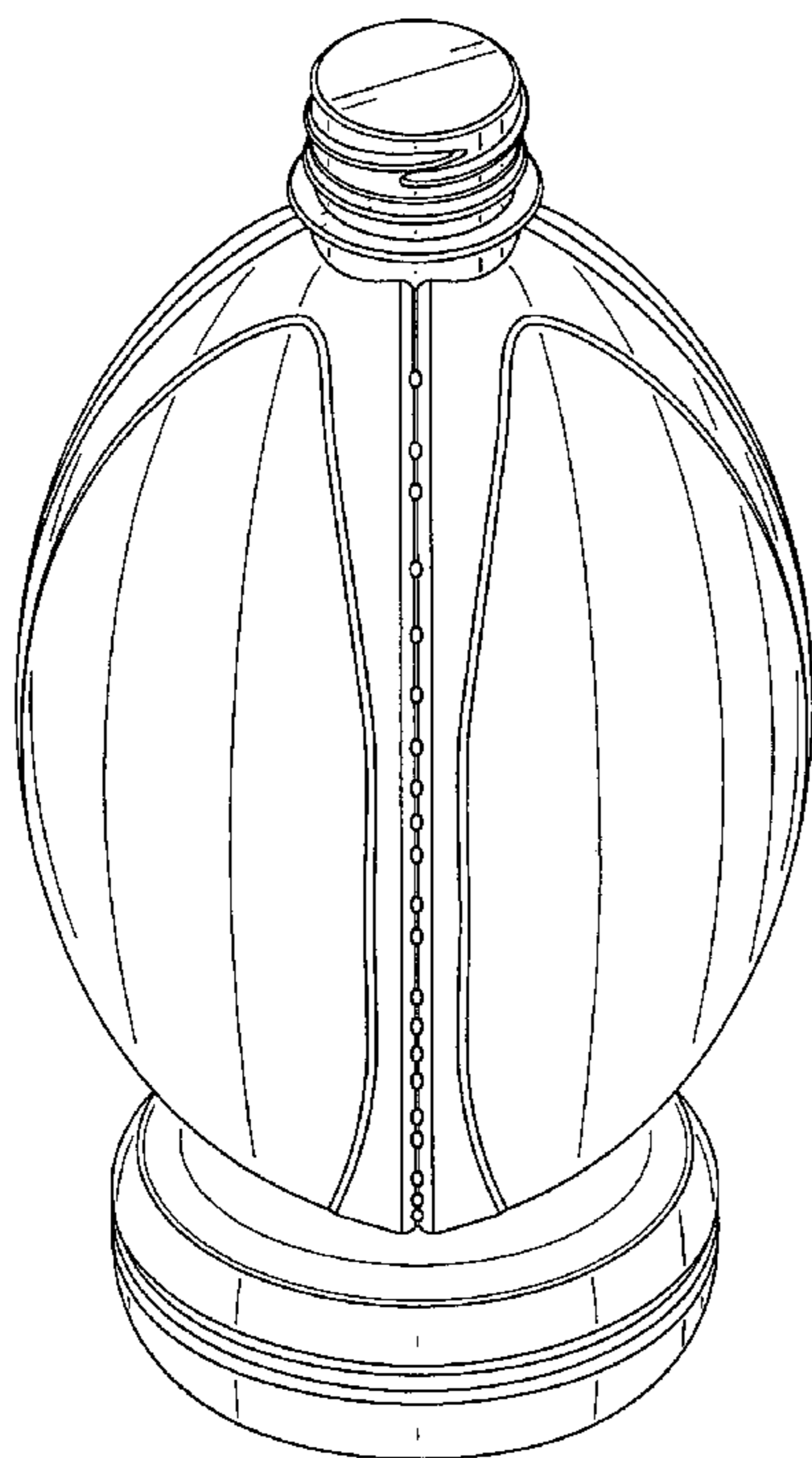

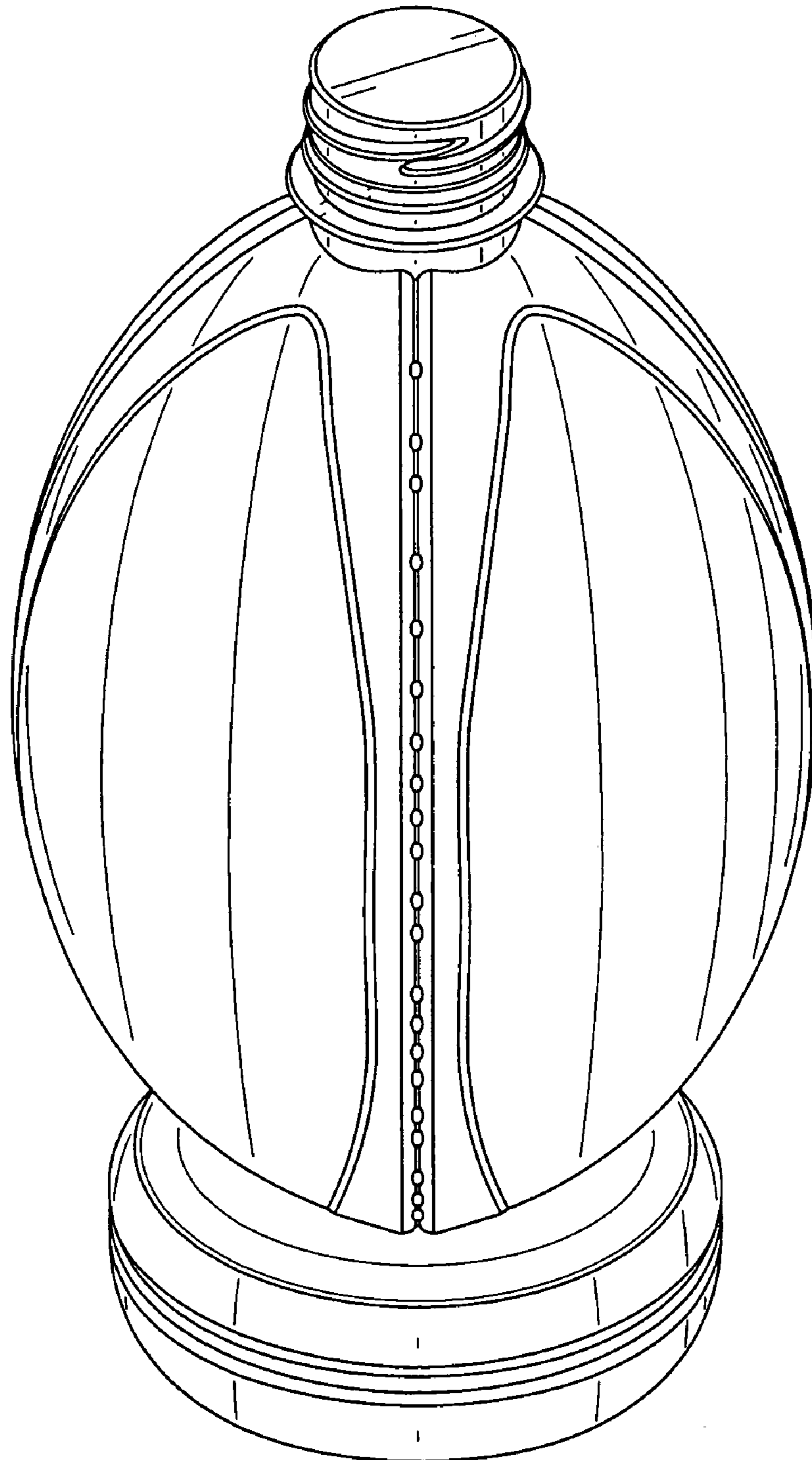

FIG. 1

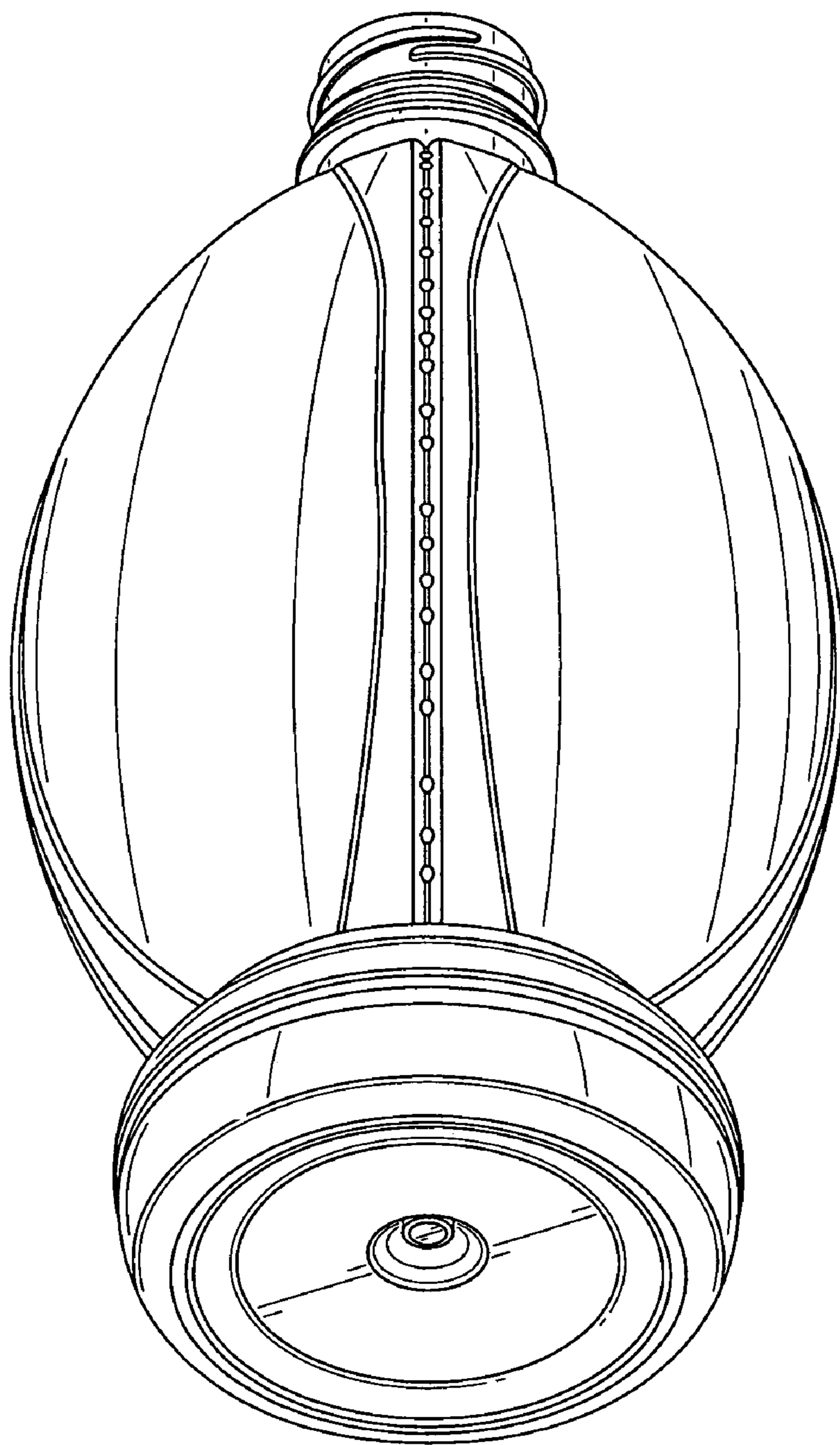

FIG. 2

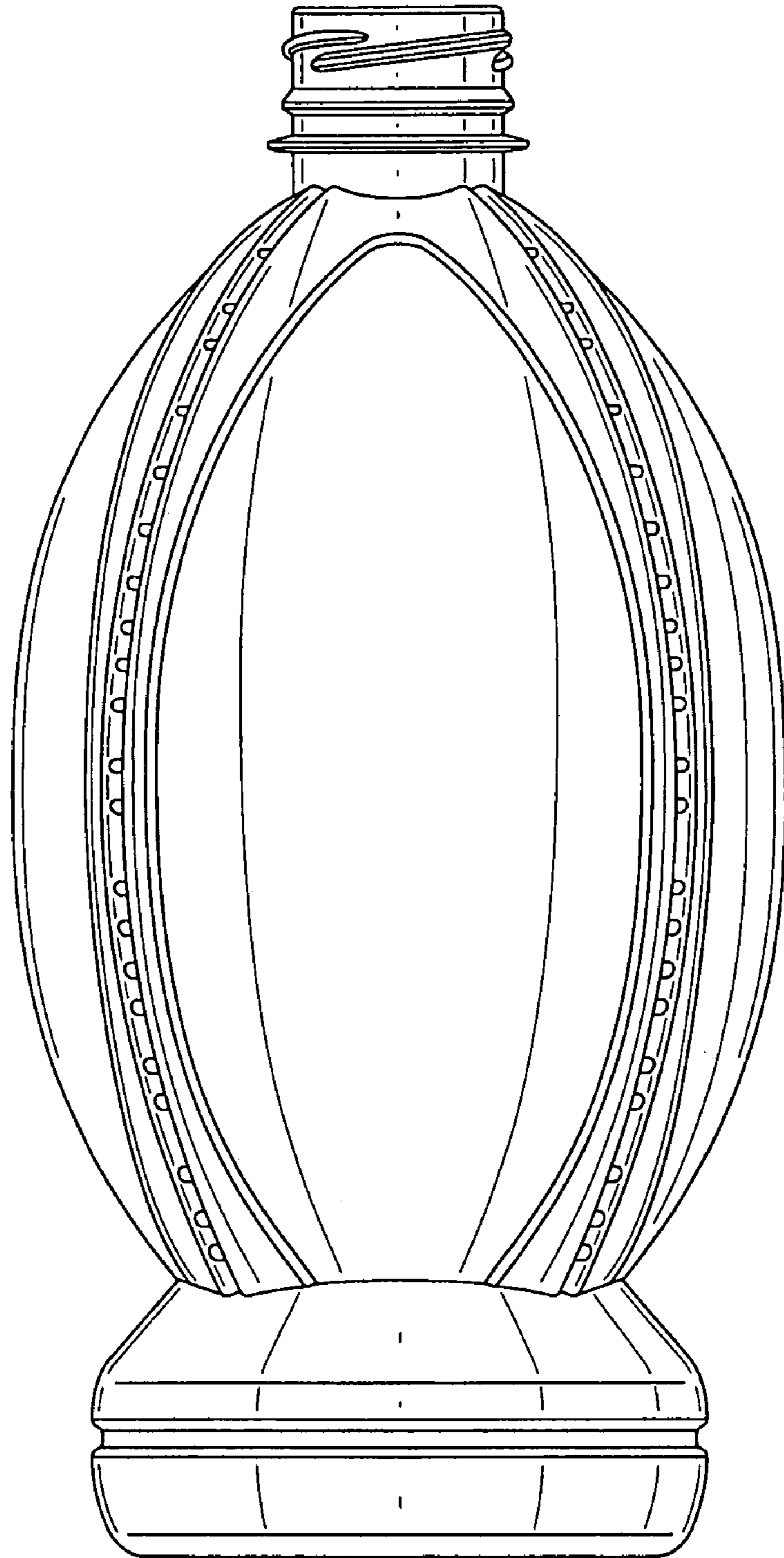

FIG. 3

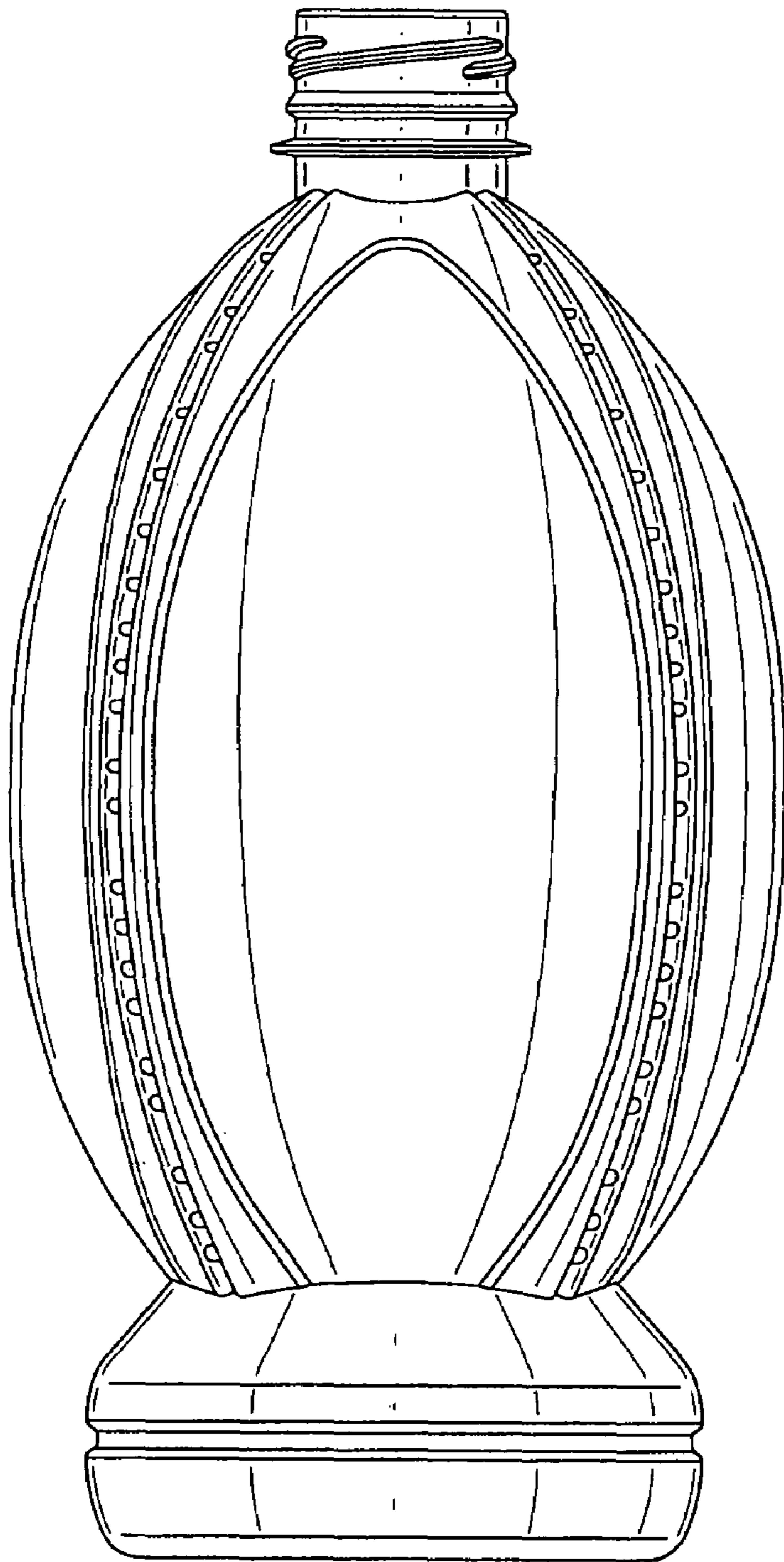

FIG. 4

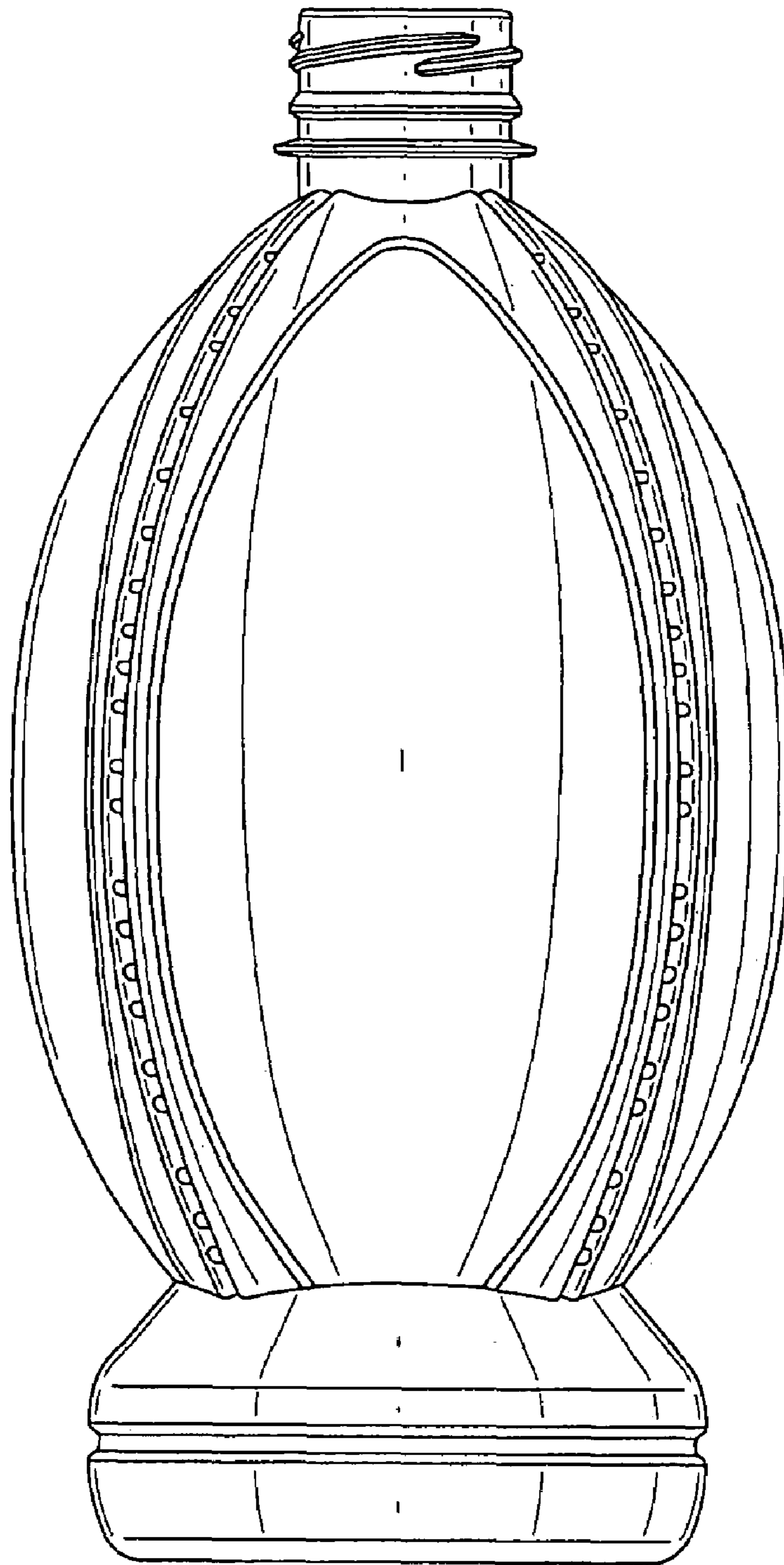

FIG. 5

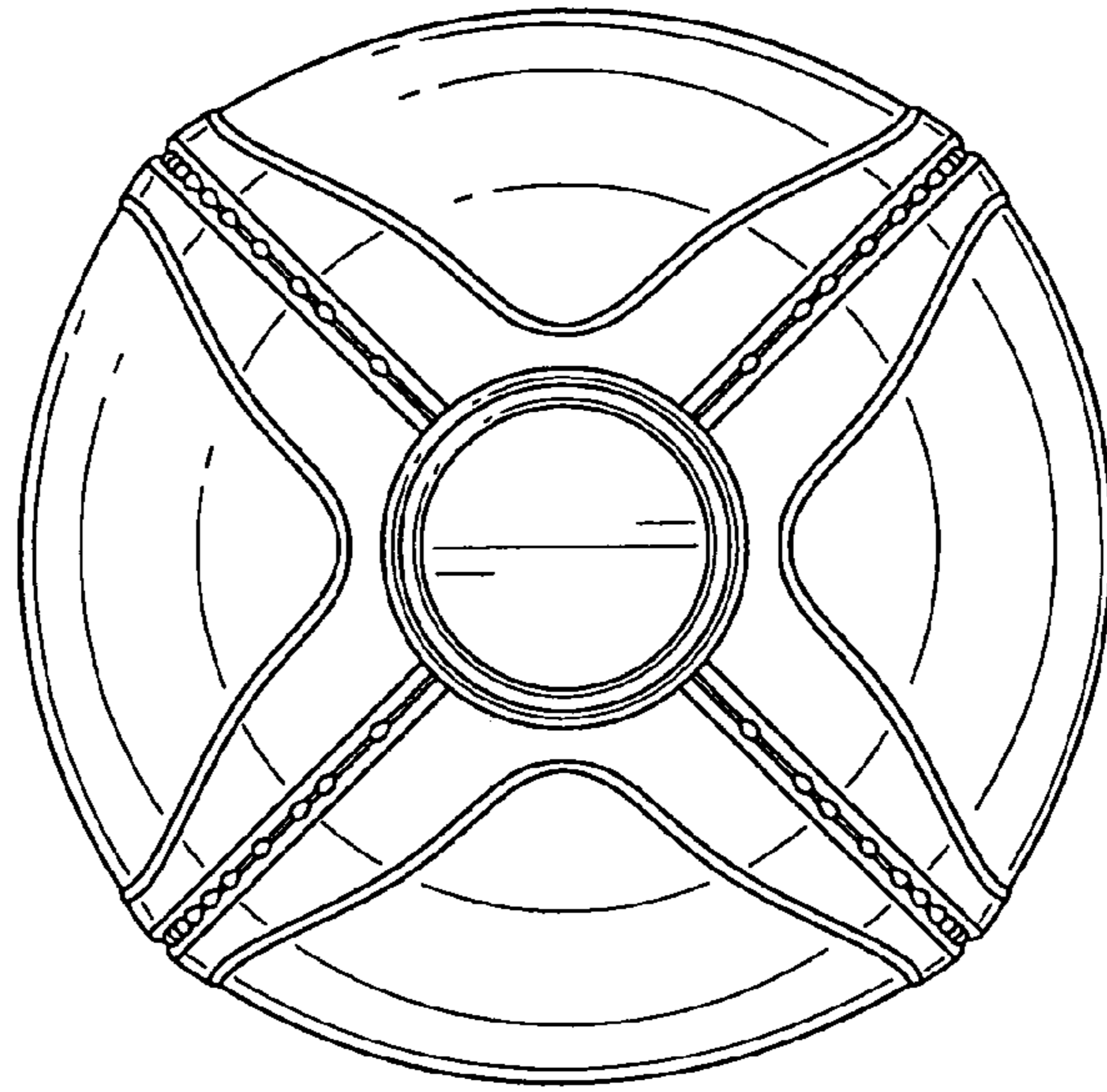

FIG. 6

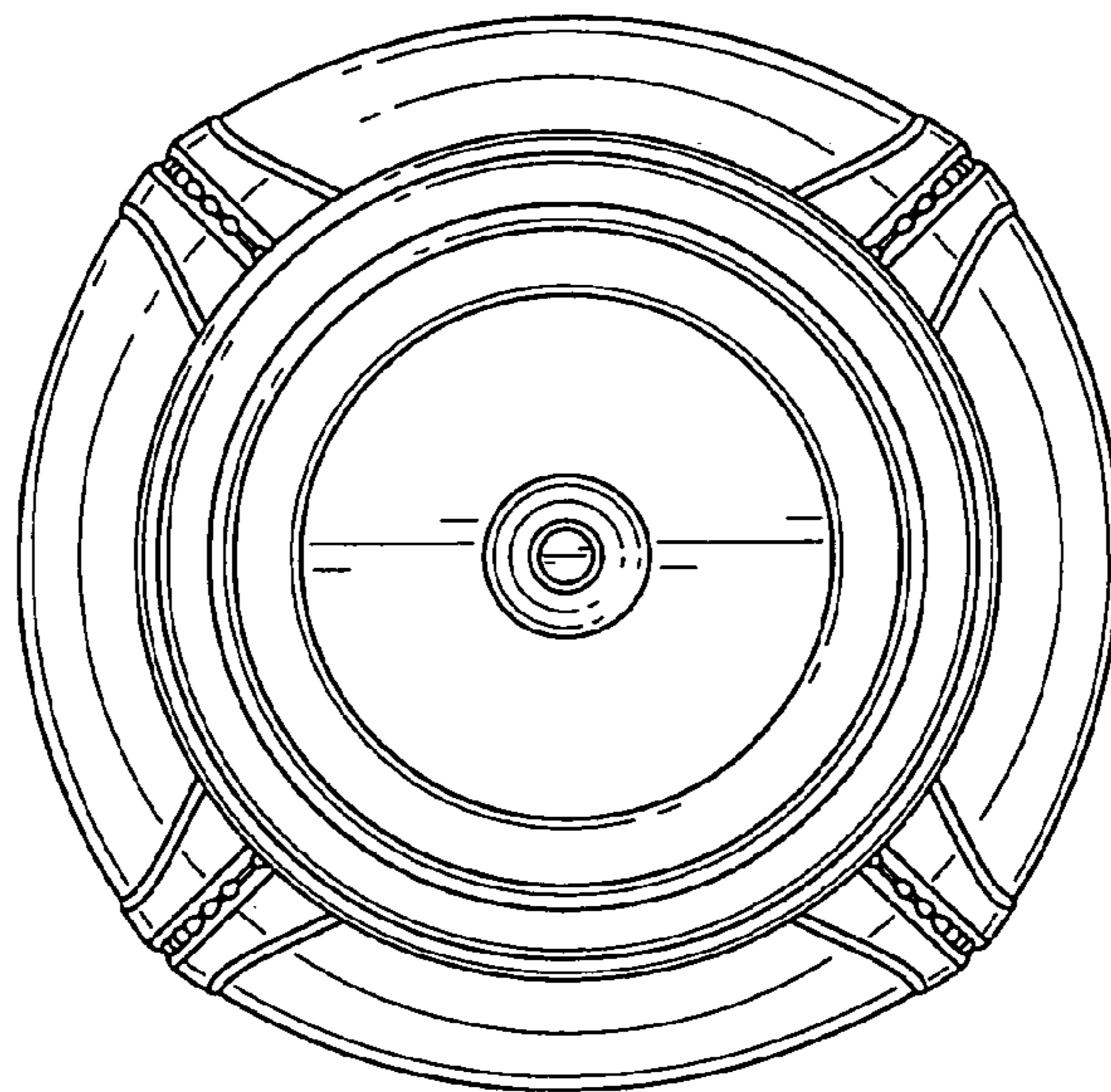

FIG. 7