



US00D576036S

(12) **United States Design Patent**  
**Dell'Accio**

(10) **Patent No.:** **US D576,036 S**

(45) **Date of Patent:** **\*\* Sep. 2, 2008**

(54) **CAP FOR PACKAGING CONTAINER**

(75) Inventor: **Vincent Dell'Accio**, Paris (FR)

(73) Assignee: **VG Emballage**, Paris (FR)

(\*\*) Term: **14 Years**

(21) Appl. No.: **29/280,093**

(22) Filed: **May 16, 2007**

(30) **Foreign Application Priority Data**

Nov. 17, 2006 (FR) ..... 06 05341

(51) **LOC (8) Cl.** ..... **09-07**

(52) **U.S. Cl.** ..... **D9/449; D9/454**

(58) **Field of Classification Search** ..... D9/453,  
D9/450, 449, 446, 438; 222/571, 567, 566,  
222/545, 544, 484, 481.5, 480; 220/810;  
215/556, 235; D28/82

See application file for complete search history.

(56) **References Cited**

**U.S. PATENT DOCUMENTS**

6,116,477 A \* 9/2000 Kreiseder et al. .... 222/556  
D438,799 S \* 3/2001 Anderson ..... D9/449  
D455,077 S \* 4/2002 Gaiser et al. .... D9/449  
D508,853 S \* 8/2005 Ziegenhorn et al. .... D9/449

2007/0138123 A1 \* 6/2007 Blomdahl et al. .... 215/235  
2007/0144996 A1 \* 6/2007 Sawyer ..... 215/235  
2007/0181523 A1 \* 8/2007 Jackel ..... 215/235

\* cited by examiner

*Primary Examiner*—Gary D. Watson

*Assistant Examiner*—Susan Bennett Hattan

(74) *Attorney, Agent, or Firm*—Oblon, Spivak, McClelland,  
Maier & Neustadt, P.C.

(57) **CLAIM**

The ornamental design for a cap for packaging container, as shown and described.

**DESCRIPTION**

FIG. 1 is a front elevational view of a cap for packaging container showing my new design;

FIG. 2 is a top plan view thereof;

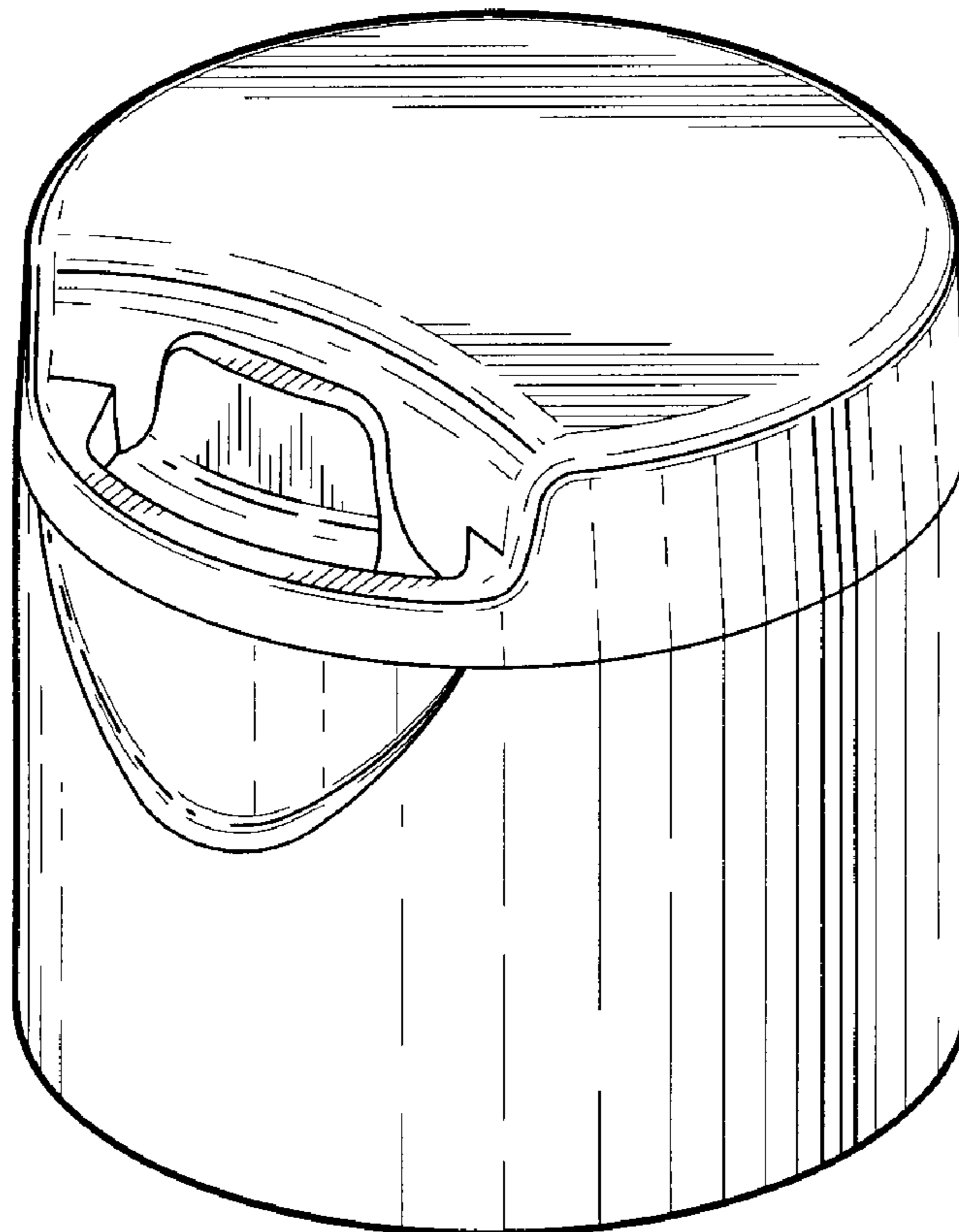
FIG. 3 is a right side elevational view thereof, the left side elevational view being a mirror image of the side view shown;

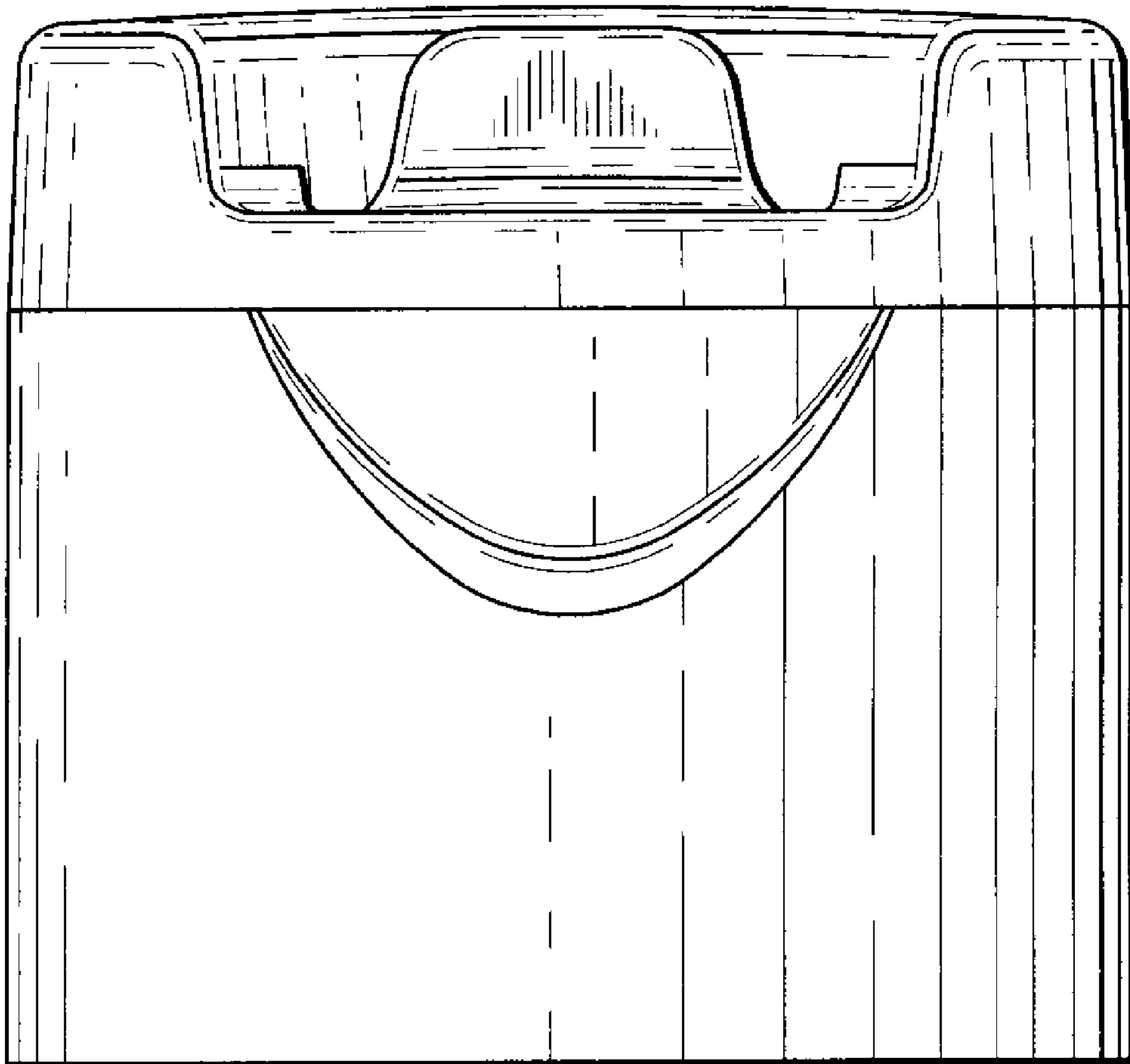
FIG. 4 is a top and right front perspective view thereof;

FIG. 5 is a bottom and front perspective view thereof; and,

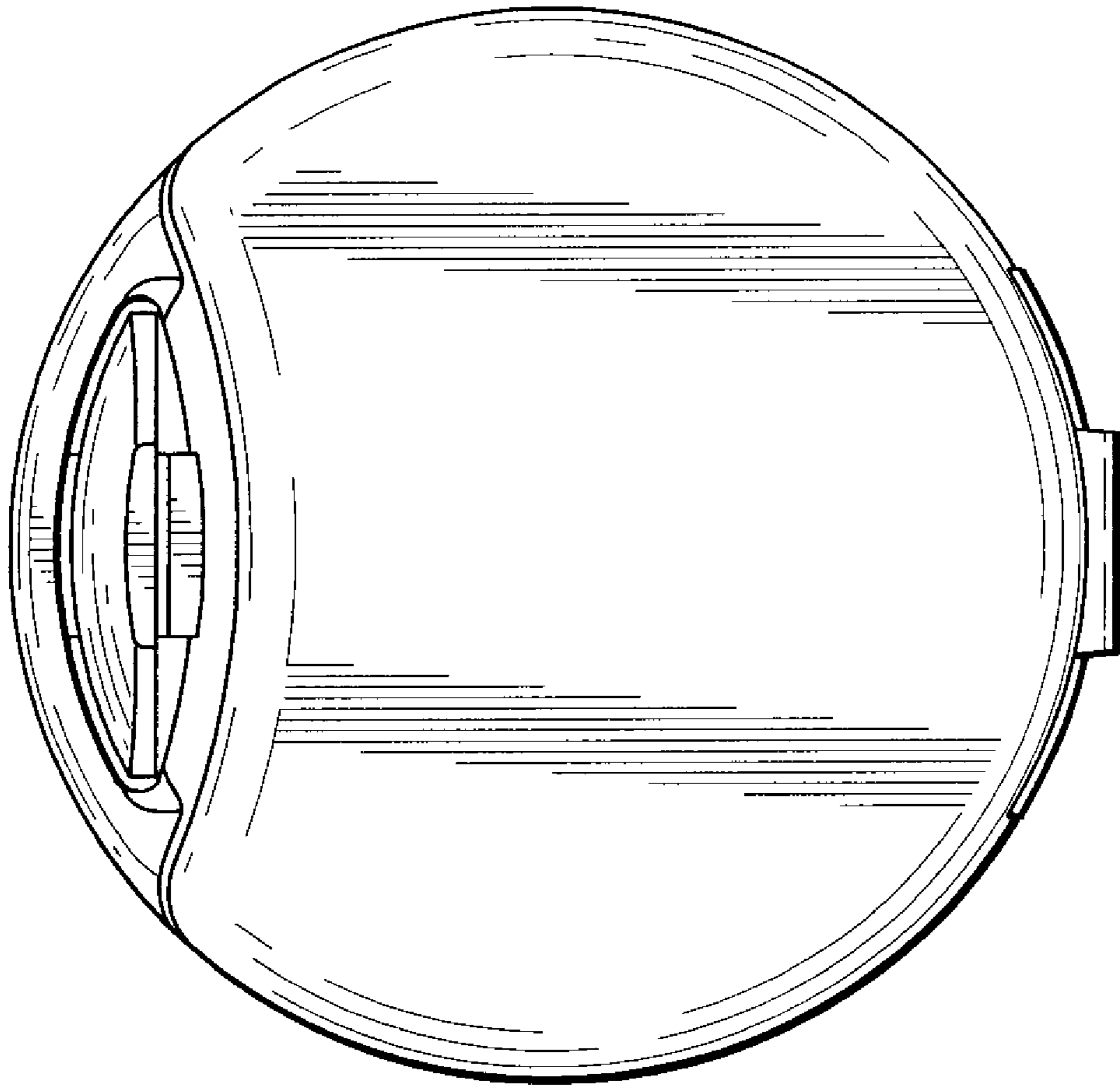
FIG. 6 is a top and right front perspective view thereof, with the cap in an open position.

**1 Claim, 6 Drawing Sheets**

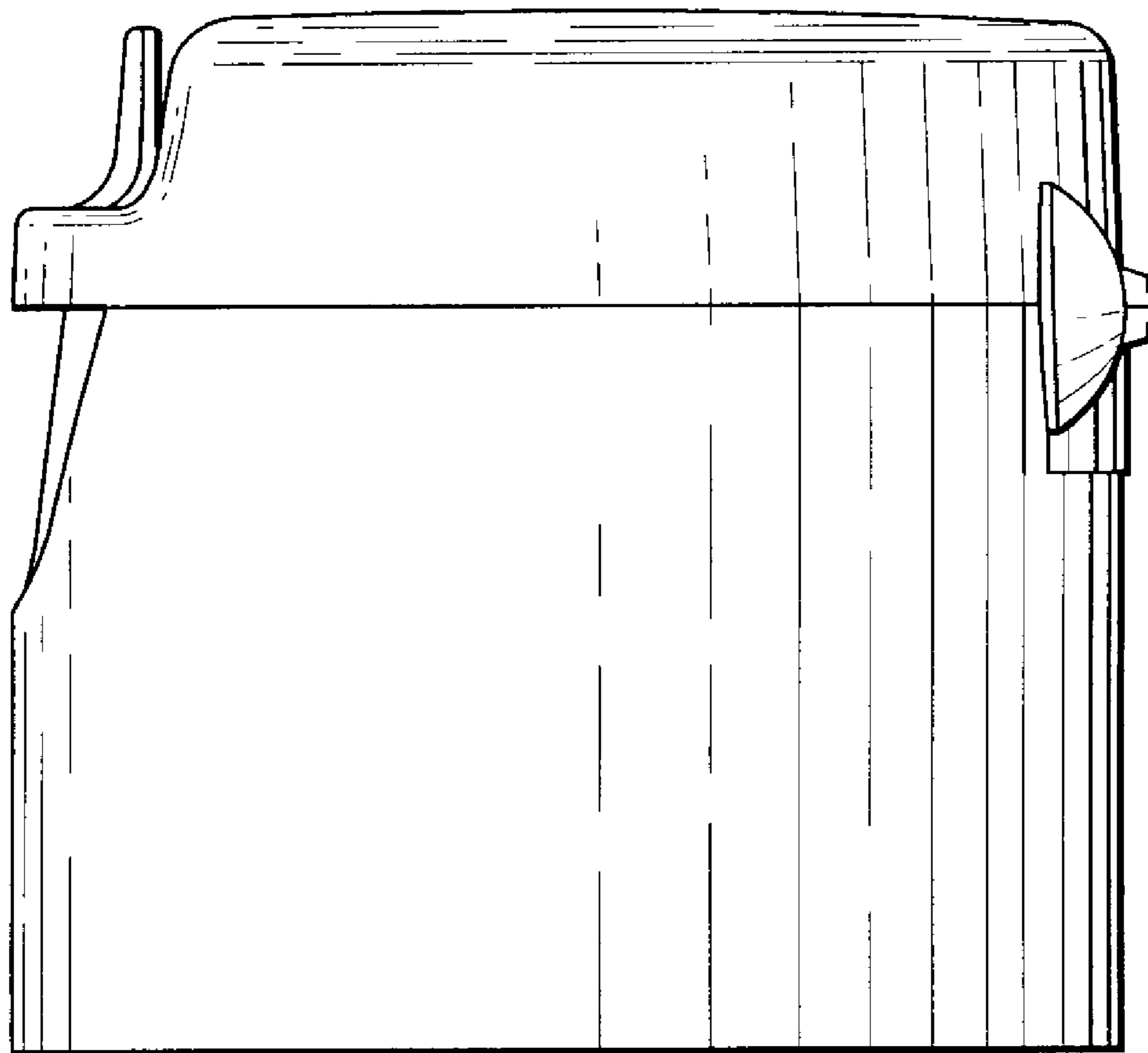




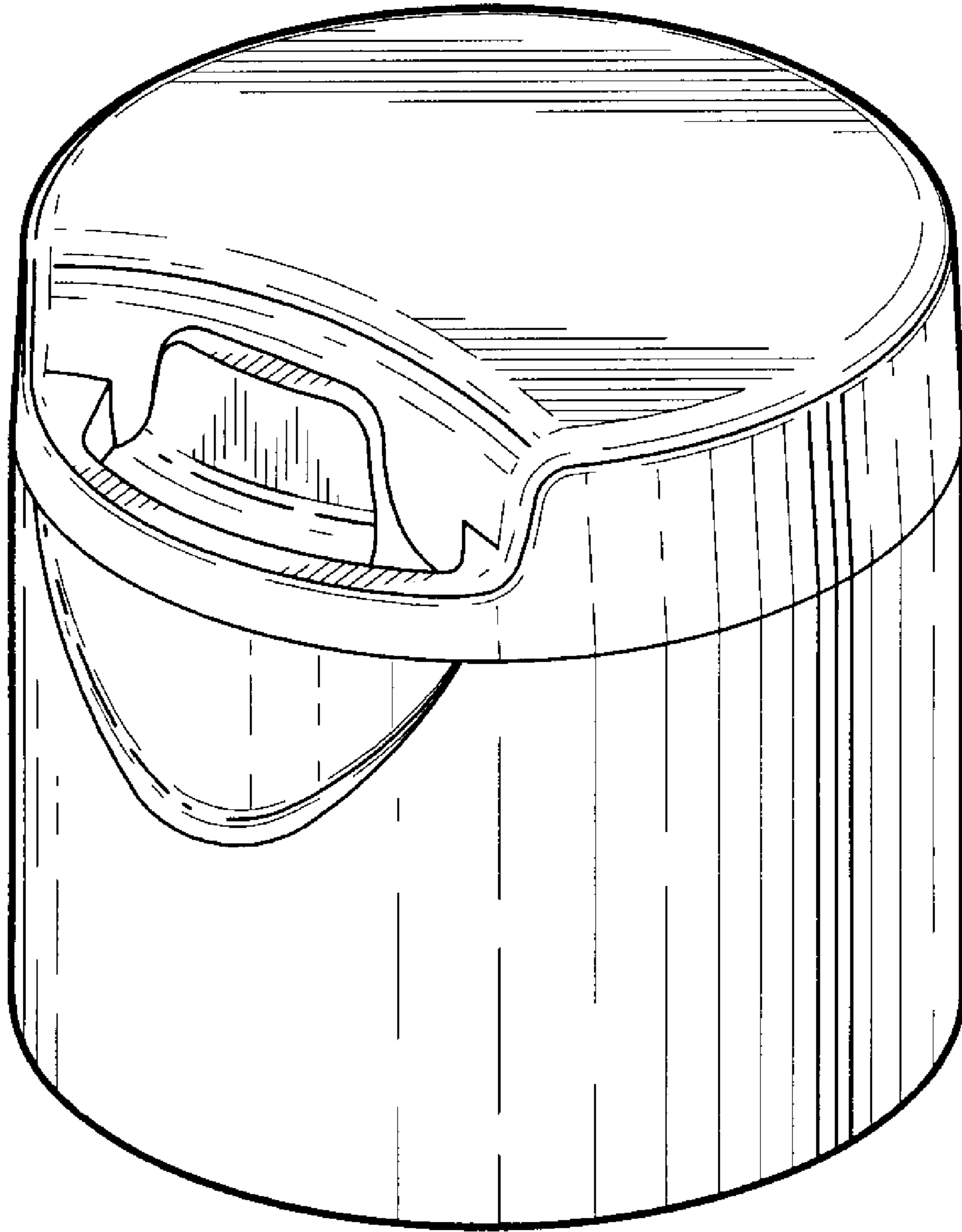
*Fig. 1*



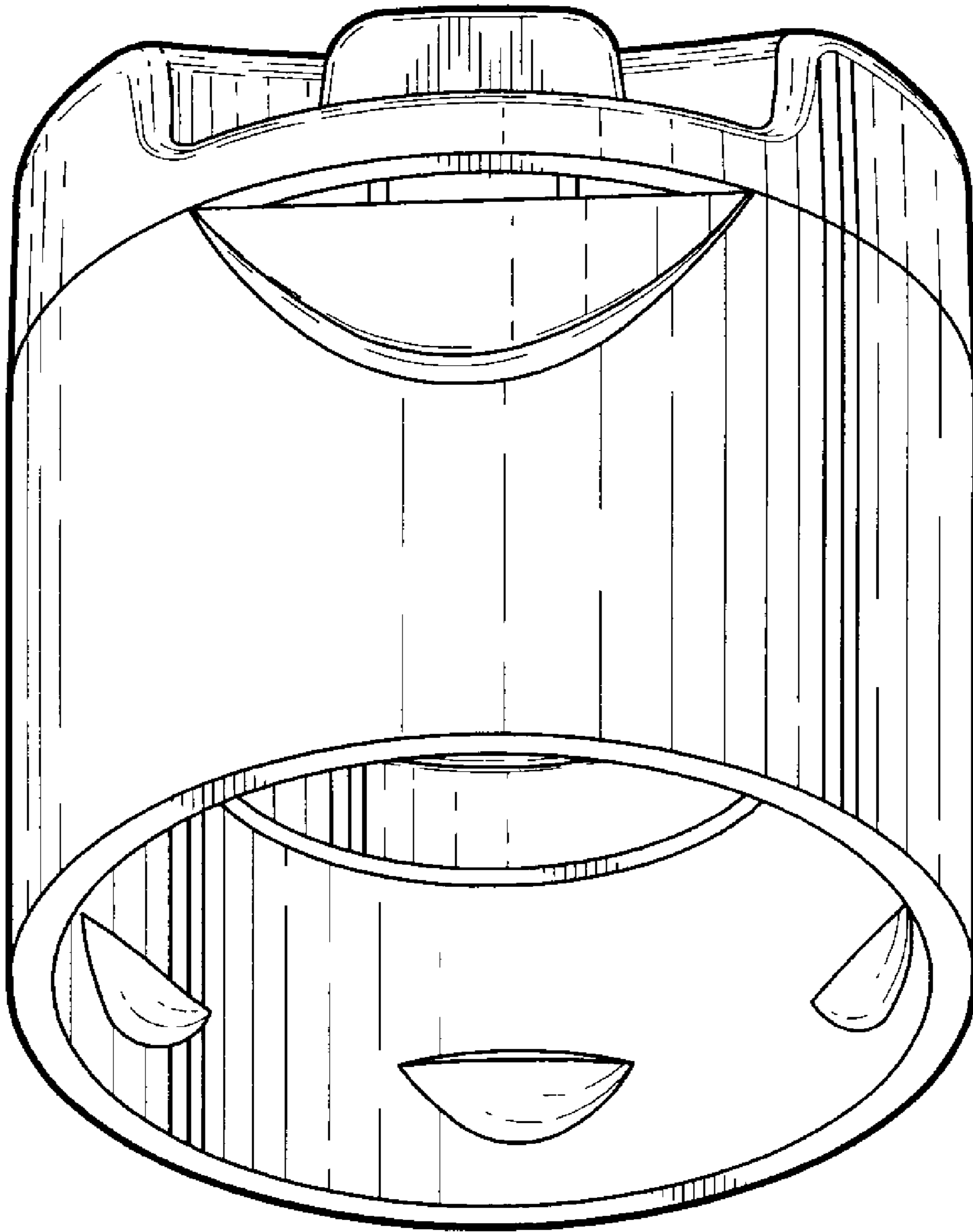
*Fig. 2*



*Fig. 3*

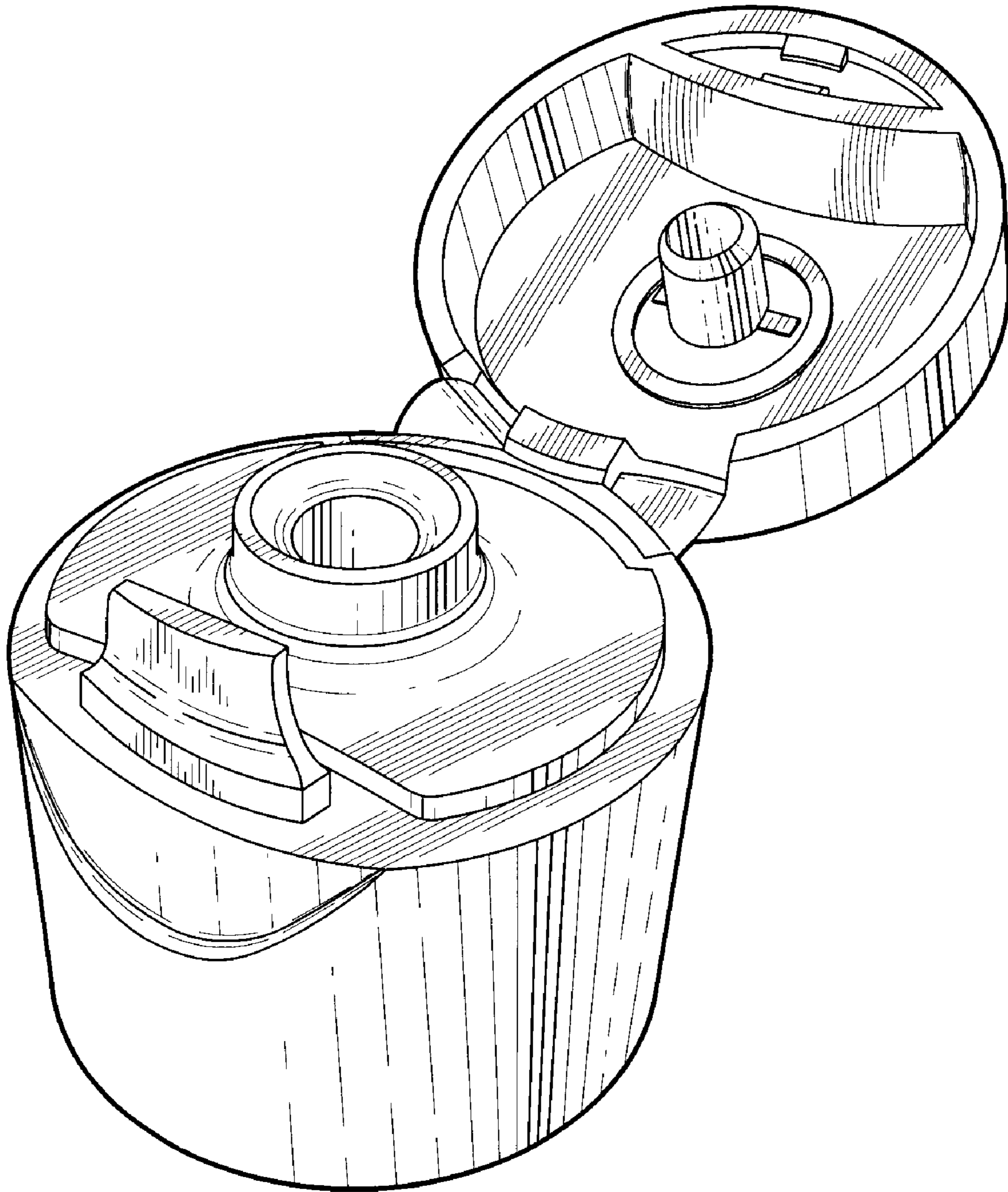


*Fig. 4*



*Fig. 5*





***Fig. 6***