



US00D576011S

(12) **United States Design Patent**
Lipscomb et al.

(10) **Patent No.:** **US D576,011 S**
(45) **Date of Patent:** **** Sep. 2, 2008**

- (54) **HANDLE FOR A HAND TOOL**
- (75) Inventors: **Daniel J. Lipscomb**, Prairie du Sac, WI (US); **Jason Crowell**, Madison, WI (US)
- (73) Assignee: **Fiskars Brands, Inc.**, Madison, WI (US)
- (**) Term: **14 Years**
- (21) Appl. No.: **29/288,210**
- (22) Filed: **Jun. 4, 2007**
- (51) **LOC (8) Cl.** **08-05**
- (52) **U.S. Cl.** **D8/107**
- (58) **Field of Classification Search** D8/4-7, D8/13, 14, 51, 52, 107; 30/251-252, 261-262
See application file for complete search history.

- D359,890 S 7/1995 Wensley
- D361,700 S 8/1995 Birkholz
- D362,162 S 9/1995 Wensley
- 5,469,625 A 11/1995 Melter et al.
- D369,531 S 5/1996 Birkholz
- 5,570,510 A 11/1996 Lindén
- D377,588 S 1/1997 Birkholz
- 5,636,443 A 6/1997 Lindén
- D387,647 S 12/1997 Lindén
- 5,697,159 A 12/1997 Lindén
- D393,193 S 4/1998 Schneider et al.
- 5,765,289 A 6/1998 Schulz et al.
- D413,503 S * 9/1999 Dugdale D8/99
- D426,447 S * 6/2000 Chau D8/105
- 6,105,257 A 8/2000 Rutkowski et al.
- 6,493,943 B1 12/2002 Lindén

(Continued)

OTHER PUBLICATIONS

U.S. Appl. No. 29/288,209, filed Jun. 4, 2007, Lipscomb et al.

(Continued)

Primary Examiner—Barbara Fox
(74) *Attorney, Agent, or Firm*—Foley & Lardner LLP

(56) **References Cited**

U.S. PATENT DOCUMENTS

- D47,855 S * 9/1915 Martin D8/56
- D301,537 S 6/1989 Pittaway
- D301,538 S 6/1989 Pittaway
- D305,090 S 12/1989 Collins et al.
- D305,495 S 1/1990 Carter
- 4,947,553 A 8/1990 Bendickson et al.
- 4,964,216 A 10/1990 Gosselin
- 5,020,222 A 6/1991 Gosselin et al.
- 5,058,277 A 10/1991 Kishimoto
- D335,807 S 5/1993 Birkholz
- D336,222 S 6/1993 Wensley et al.
- D336,412 S 6/1993 Wensley et al.
- D339,725 S 9/1993 Birkholz
- 5,243,762 A * 9/1993 Orthey 30/254
- D342,652 S 12/1993 Wensley et al.
- D344,218 S 2/1994 Wensley et al.
- D344,219 S 2/1994 Wensley et al.
- D344,220 S 2/1994 Wensley et al.
- D350,466 S 9/1994 Ramsey et al.
- D353,087 S 12/1994 Ramsey et al.
- D354,205 S 1/1995 Wensley et al.
- D354,890 S 1/1995 Concari et al.
- D358,748 S 5/1995 Ramsey et al.
- D359,427 S 6/1995 Birkholz
- 5,426,857 A 6/1995 Lindén

(57) **CLAIM**

We claim the ornamental design for a handle for a hand tool, as shown and described.

DESCRIPTION

FIG. 1 is a perspective view of the claimed design.
 FIG. 2 is a left side elevation view of the claimed design.
 FIG. 3 is a right side elevation view of the claimed design.
 FIG. 4 is a top view of the claimed design.
 FIG. 5 is a bottom view of the claimed design.
 FIG. 6 is a front elevation view of the claimed design; and,
 FIG. 7 is a rear elevation view of the claimed design.

The broken lines in the drawings are for illustrative purposes only and form no part of the claimed design.

1 Claim, 3 Drawing Sheets

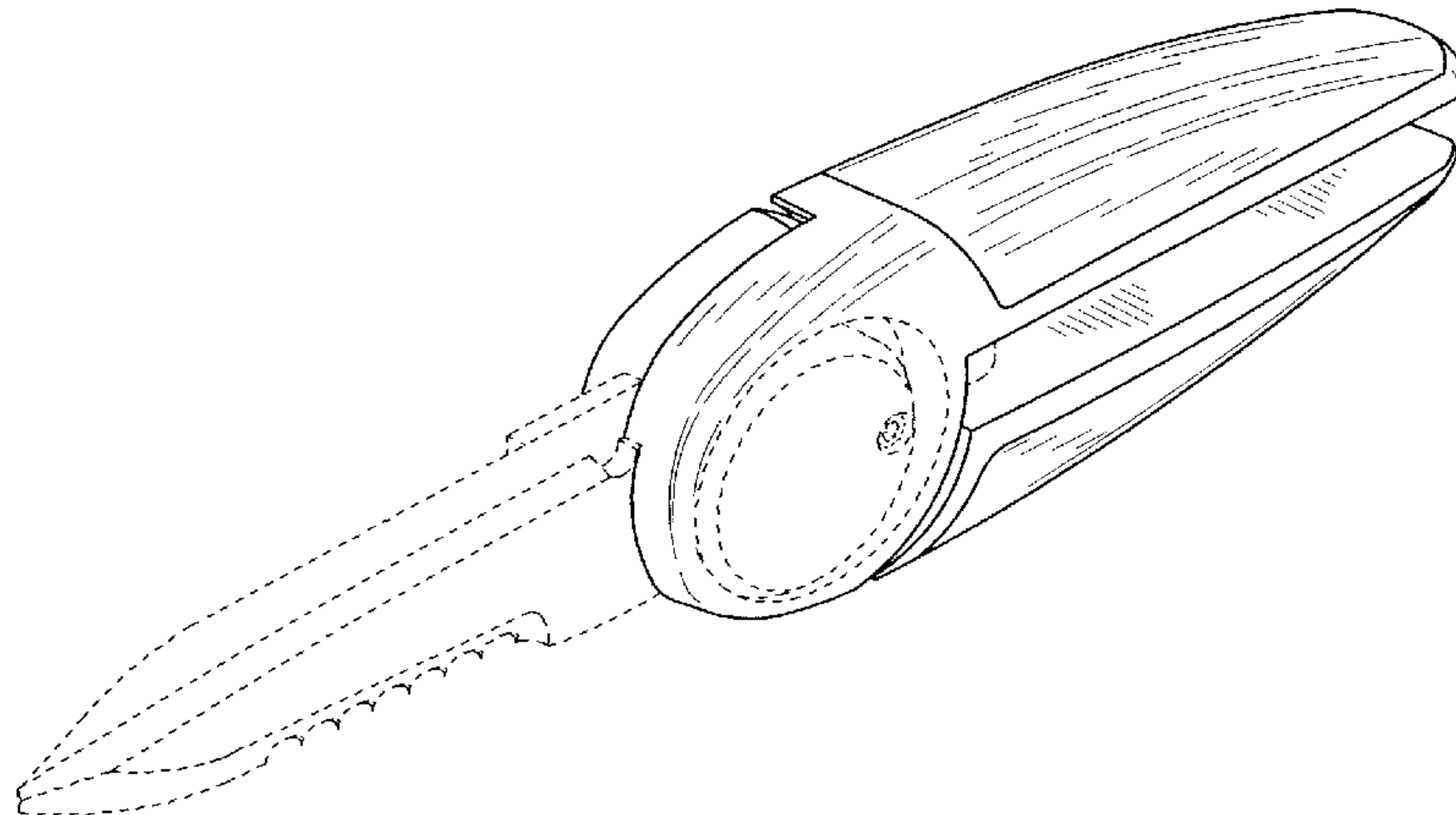

US D576,011 S

Page 2

U.S. PATENT DOCUMENTS

D469,323 S 1/2003 Lindén
6,513,248 B2 2/2003 Lindén et al.
6,789,324 B2 9/2004 Lindén et al.
D499,621 S * 12/2004 Tsuda D8/52
6,829,828 B1 12/2004 Cech et al.
D501,379 S 2/2005 Lipscomb et al.
D503,595 S 4/2005 Lipscomb et al.
D503,880 S 4/2005 McLean

6,938,347 B2 9/2005 Lindén et al.
D534,563 S * 1/2007 Yip D16/135
D536,940 S * 2/2007 Peterson et al. D8/57
2003/0079576 A1* 5/2003 Lo 81/318

OTHER PUBLICATIONS

U.S. Appl. No. 11/809,991, filed Jun. 4, 2007, Lipscomb et al.
U.S. Appl. No. 11/809,986, filed Jun. 4, 2007, Lipscomb et al.

* cited by examiner

FIGURE 1

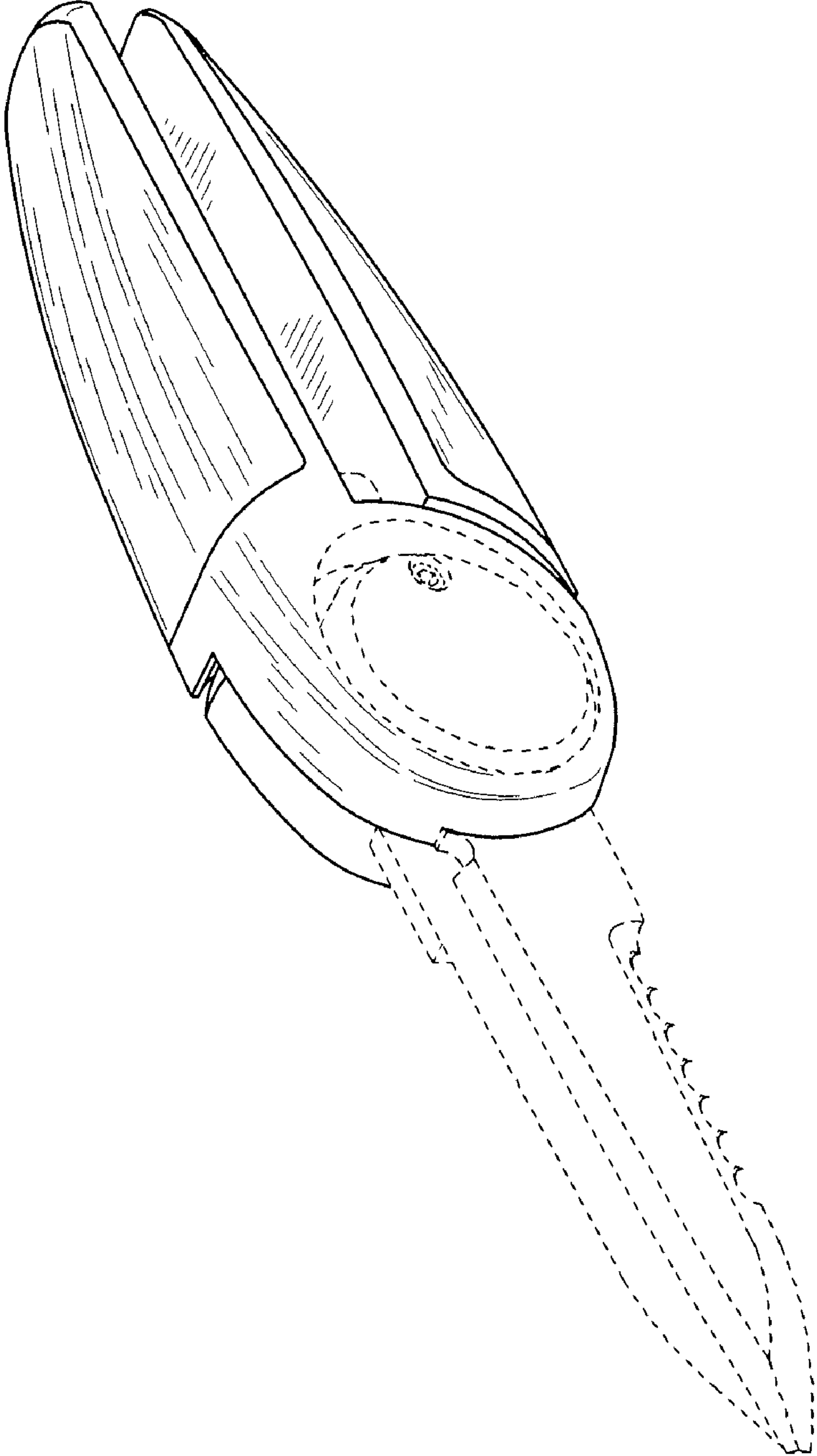

FIGURE 2

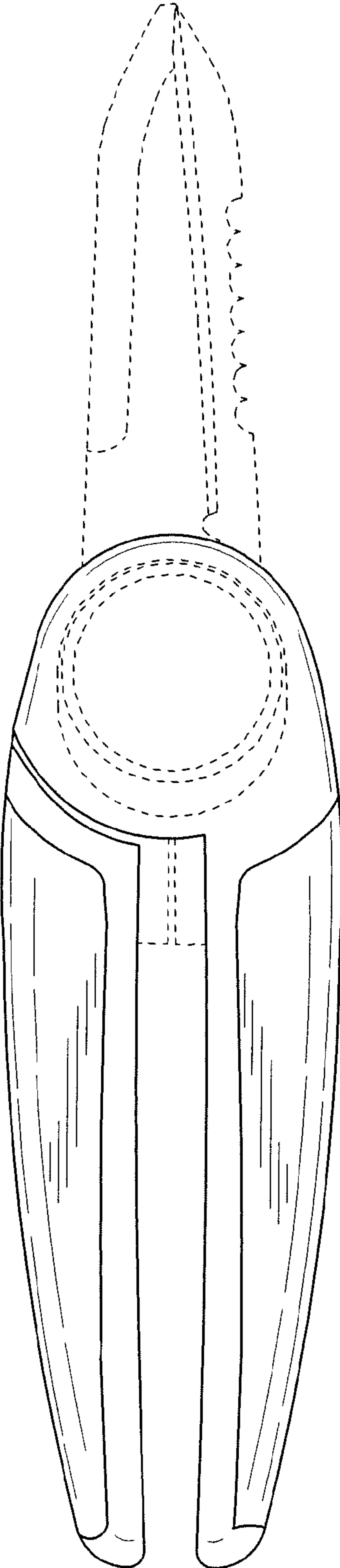

FIGURE 3

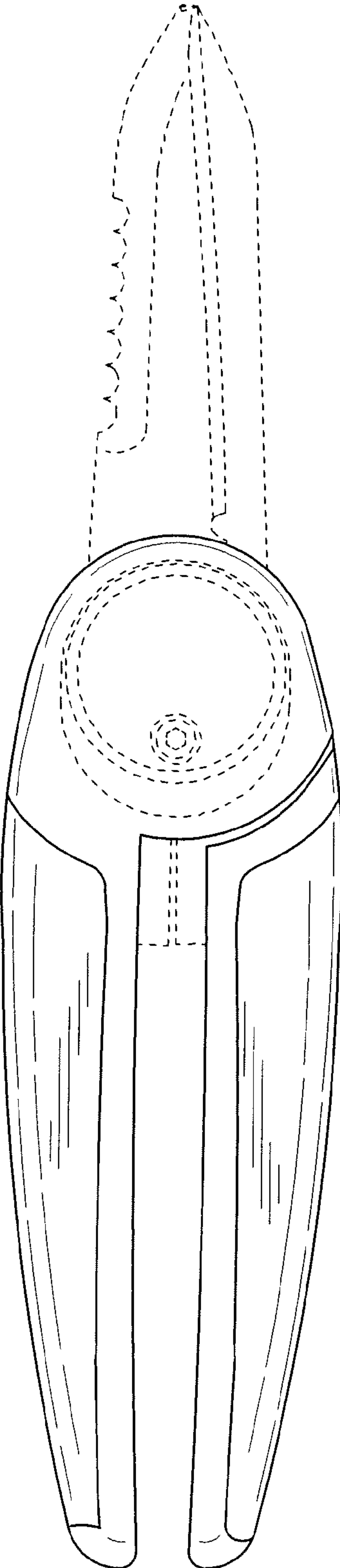

FIGURE 4

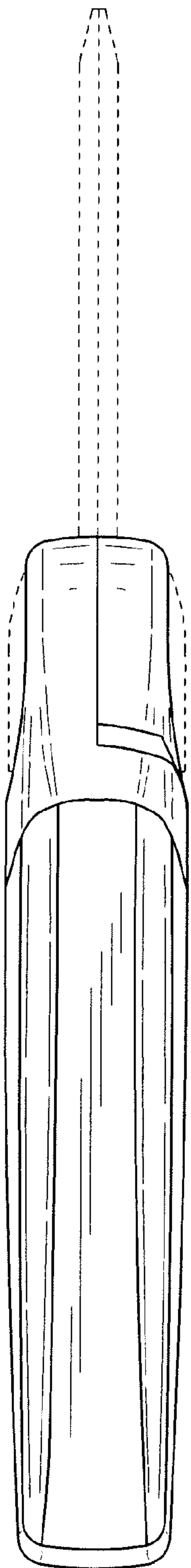

FIGURE 5

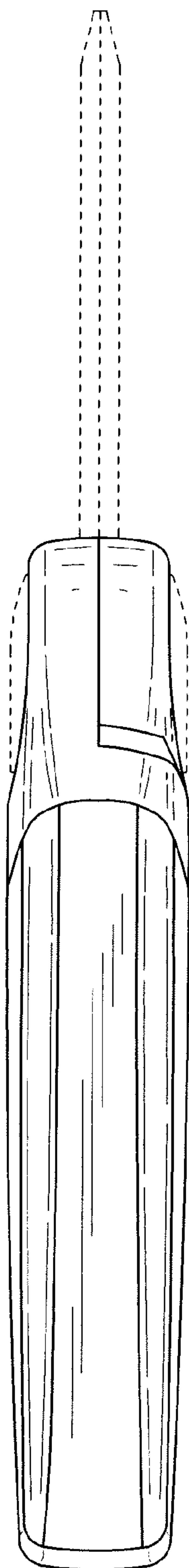

FIGURE 6

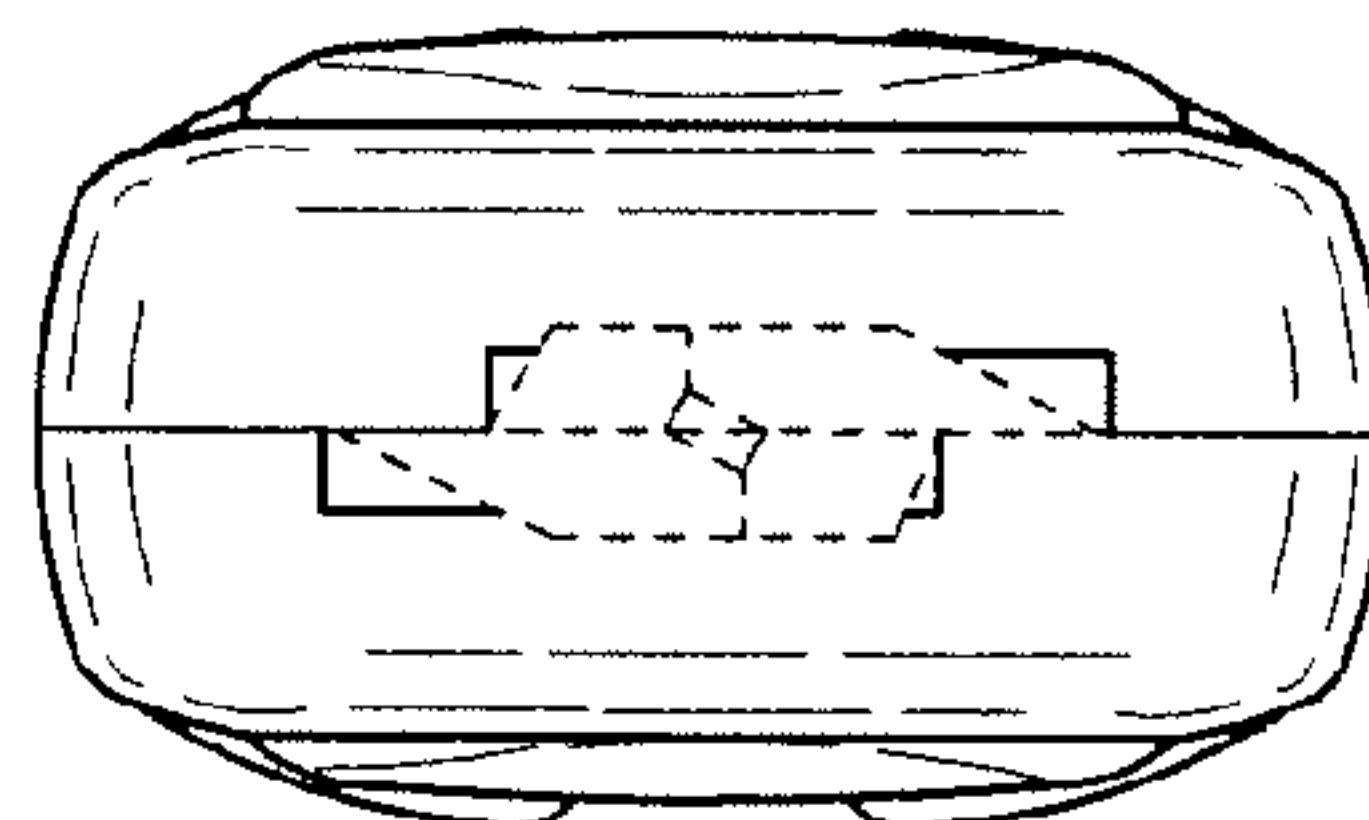

FIGURE 7

