



US00D575979S

(12) **United States Design Patent**  
**Borin**

(10) **Patent No.:** **US D575,979 S**

(45) **Date of Patent:** **\*\* Sep. 2, 2008**

(54) **ELECTRIC OVEN**

(75) Inventor: **Giacomo Borin**, Pordenone (IT)

(73) Assignee: **De' Longhi S.p.A.**, Treviso (IT)

(\*\*) Term: **14 Years**

(21) Appl. No.: **29/292,724**

(22) Filed: **Oct. 25, 2007**

(30) **Foreign Application Priority Data**

Apr. 26, 2007 (EM) ..... 000713516

(51) **LOC (8) Cl.** ..... **07-02**

(52) **U.S. Cl.** ..... **D7/350.1**

(58) **Field of Classification Search** ..... D7/350.1,  
D7/350.3, 350.4, 351, 402, 405; 126/19 M,  
126/21 R, 275 E, 273 A; 219/757, 758  
See application file for complete search history.

(56) **References Cited**

**U.S. PATENT DOCUMENTS**

- D245,470 S \* 8/1977 Ernest ..... D7/350.4
- D336,814 S \* 6/1993 Brookshire ..... D7/350.4
- D380,643 S \* 7/1997 Piret ..... D7/350.4
- D381,861 S \* 8/1997 Rorke et al. .... D7/350.4
- D386,938 S \* 12/1997 Piret ..... D7/350.4

- D412,637 S \* 8/1999 Piret ..... D7/350.4
- D415,926 S \* 11/1999 De'Longhi ..... D7/350.4
- D420,245 S \* 2/2000 De'Longhi ..... D7/350.4
- D444,992 S \* 7/2001 Brady et al. .... D7/350.4
- D451,752 S \* 12/2001 Davis et al. .... D7/350.4

\* cited by examiner

*Primary Examiner*—Ruth McInroy

(74) *Attorney, Agent, or Firm*—Hamre, Schumann, Mueller & Larson, P.C.

(57) **CLAIM**

The ornamental design for an electric oven, as shown and described.

**DESCRIPTION**

FIG. 1 is a perspective view of an electric oven in accordance with my invention thereof;

FIG. 2 is a front view thereof;

FIG. 3 is a left side view thereof;

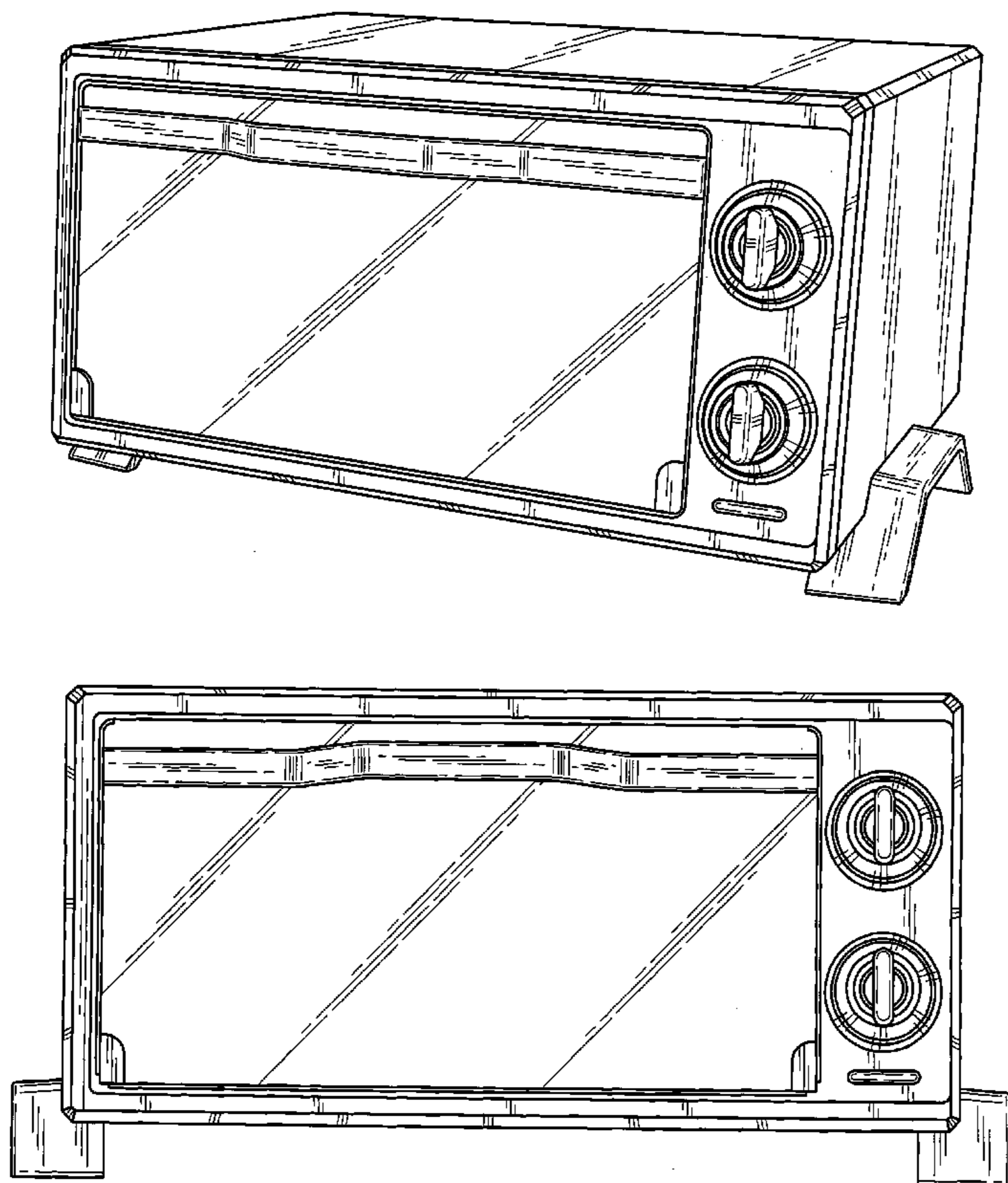
FIG. 4 is a right side view thereof;

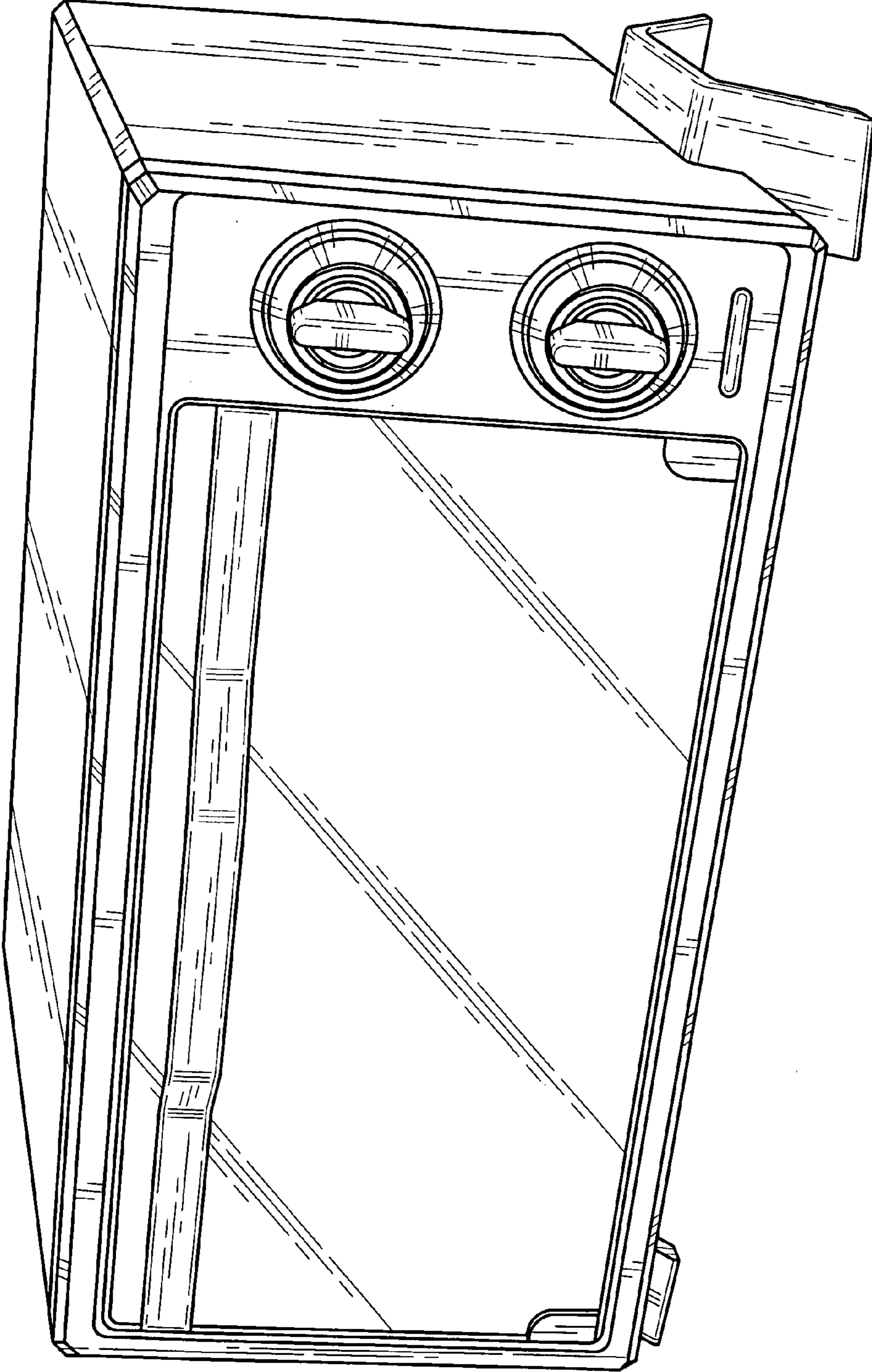
FIG. 5 is a back view thereof;

FIG. 6 is a top view thereof; and,

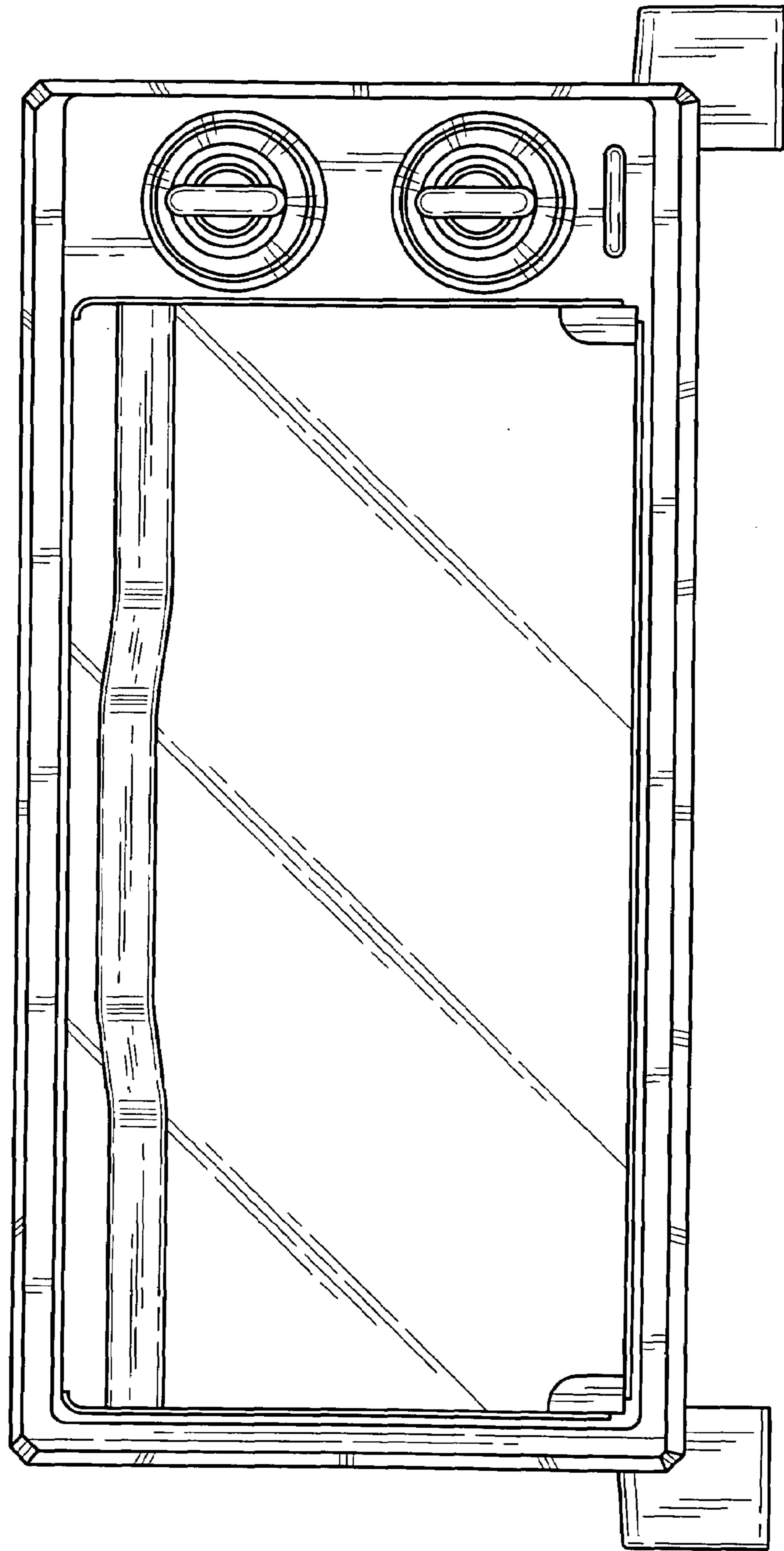
FIG. 7 is a bottom view thereof.

**1 Claim, 7 Drawing Sheets**

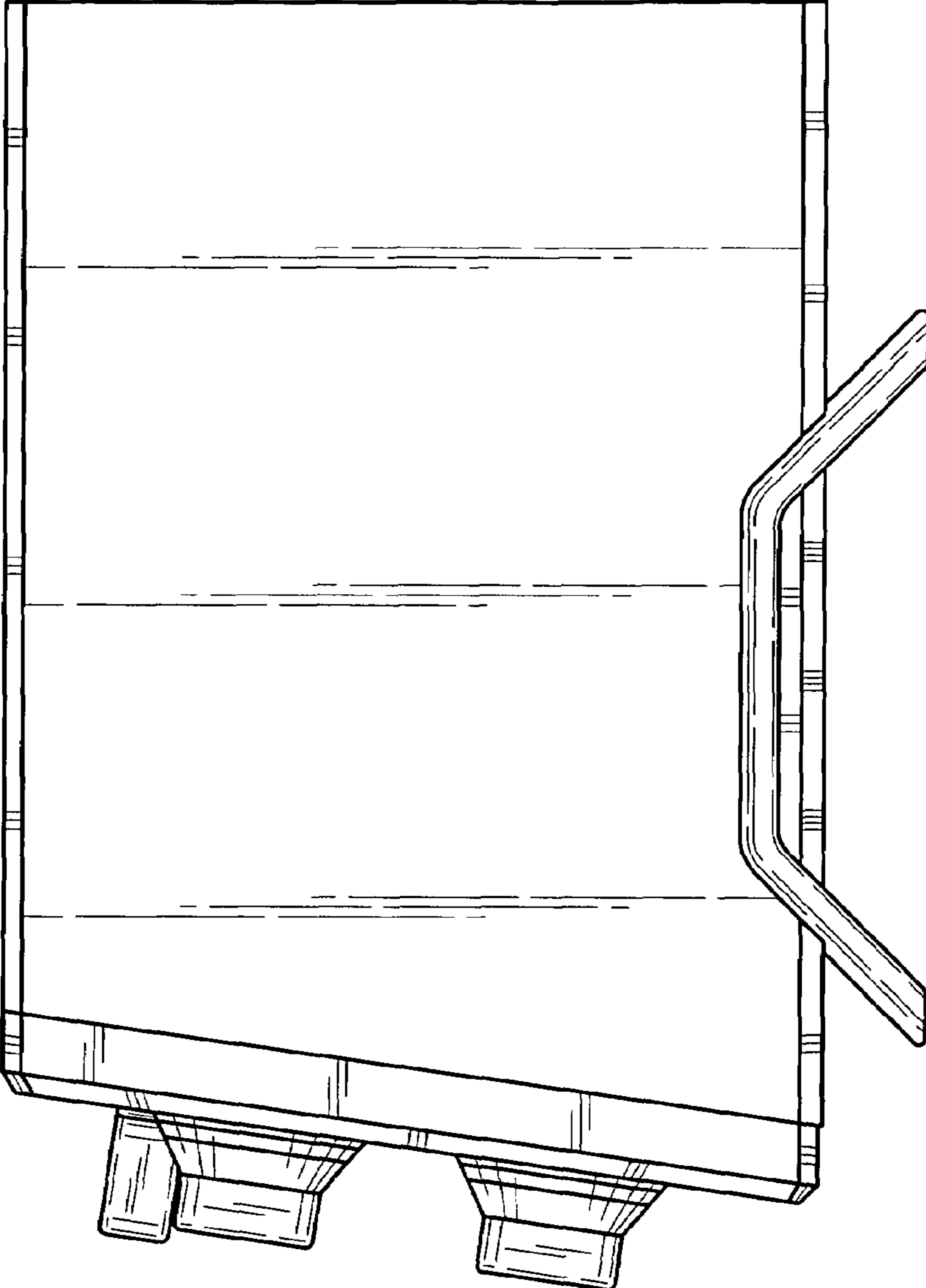




*Fig. 1*



*Fig. 2*



*Fig. 3*

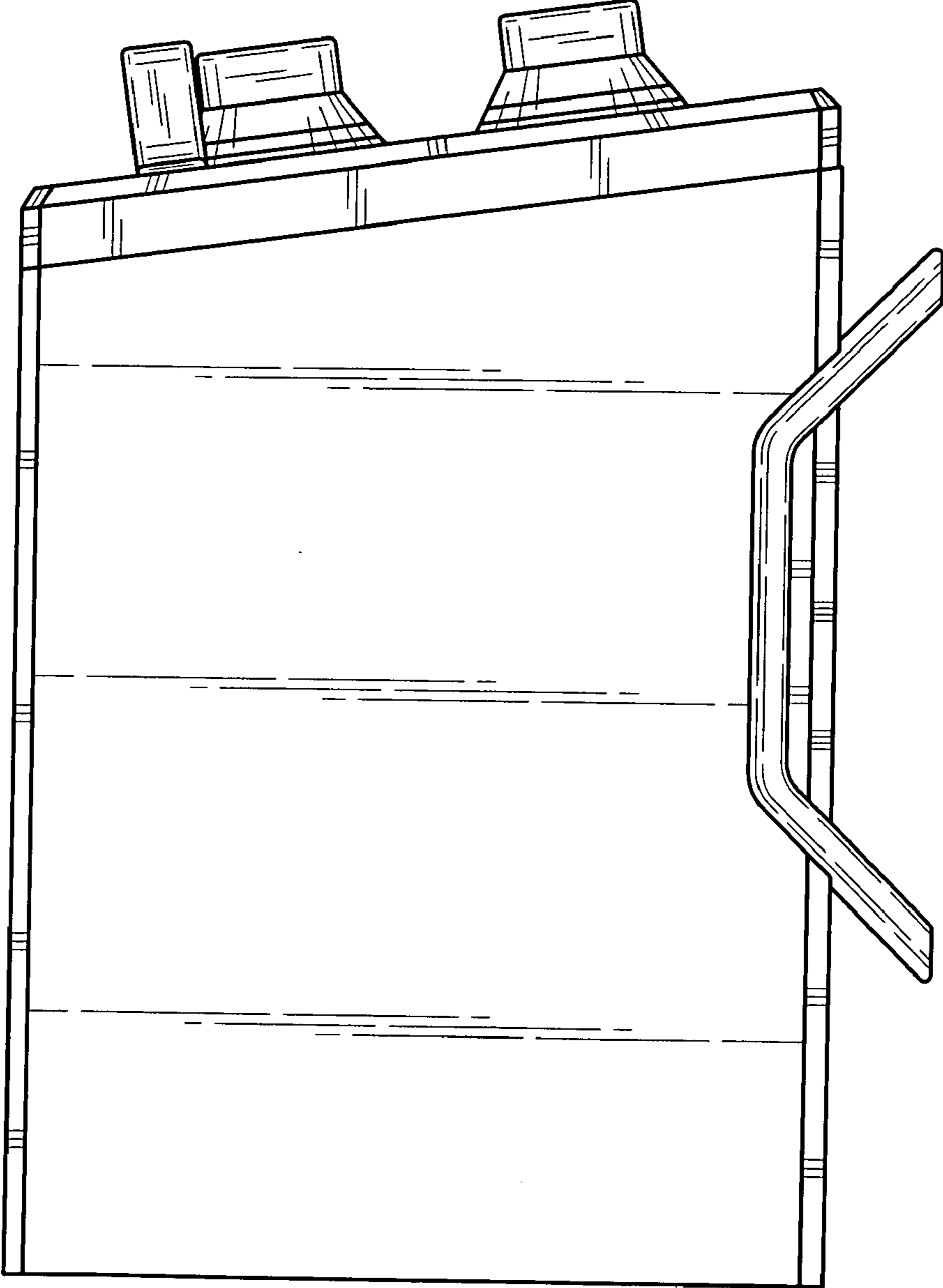
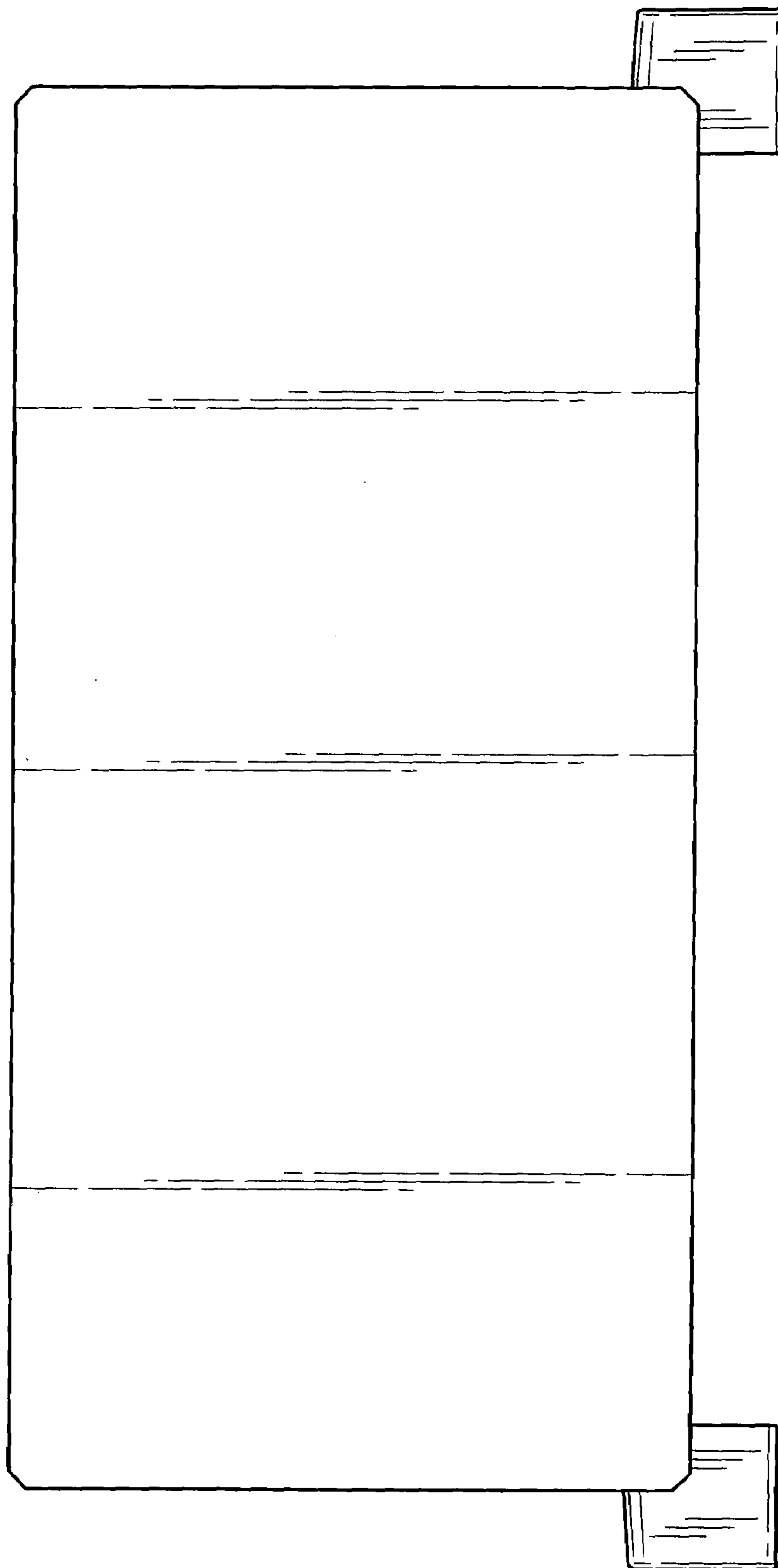


Fig. 4



*Fig. 5*

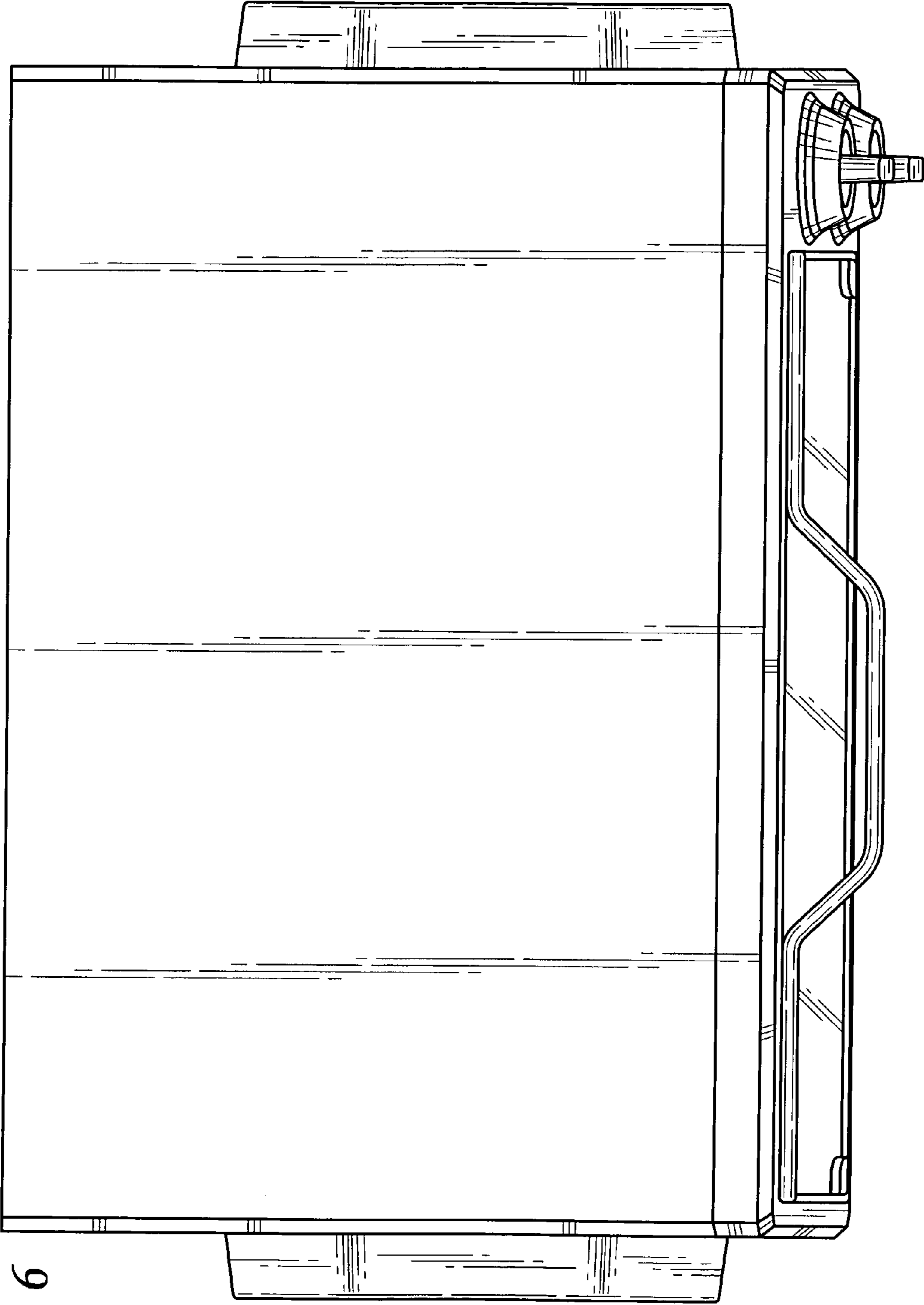


Fig. 6

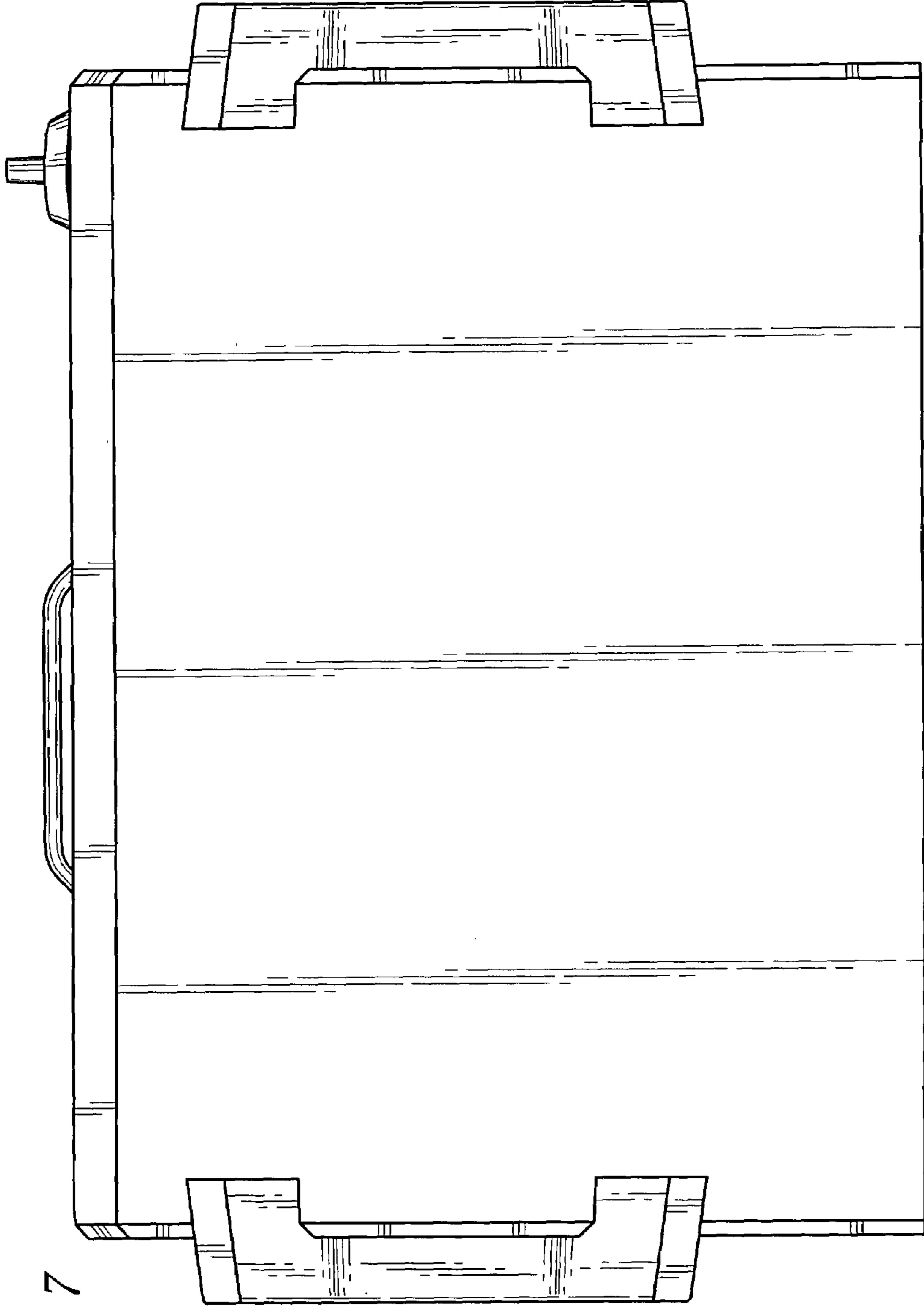


Fig. 7