



US00D575978S

(12) **United States Design Patent**
Borin

(10) **Patent No.:** **US D575,978 S**

(45) **Date of Patent:** **** Sep. 2, 2008**

(54) **ELECTRIC OVEN**

(75) Inventor: **Giacomo Borin**, Pordenone (IT)

(73) Assignee: **De' Longhi S.p.A.**, Treviso (IT)

(**) Term: **14 Years**

(21) Appl. No.: **29/292,674**

(22) Filed: **Oct. 24, 2007**

(30) **Foreign Application Priority Data**

Apr. 26, 2007 (EM) 000713516

(51) **LOC (8) Cl.** **07-02**

(52) **U.S. Cl.** **D7/350.1**

(58) **Field of Classification Search** D7/350.1,
D7/350.3, 350.4, 351, 402, 405; 126/19 M,
126/21 R, 275 E, 273 A; 219/757, 758
See application file for complete search history.

(56) **References Cited**

U.S. PATENT DOCUMENTS

- D245,470 S * 8/1977 Ernest D7/350.4
- D336,814 S * 6/1993 Brookshire D7/350.4
- D380,643 S * 7/1997 Piret D7/350.4
- D381,861 S * 8/1997 Rorke et al. D7/350.4
- D386,938 S * 12/1997 Piret D7/350.4

- D412,637 S * 8/1999 Piret D7/350.4
- D415,926 S * 11/1999 De'Longhi D7/350.4
- D420,245 S * 2/2000 De'Longhi D7/350.4
- D444,992 S * 7/2001 Brady et al. D7/350.4
- D451,752 S * 12/2001 Davis et al. D7/350.4

* cited by examiner

Primary Examiner—Ruth McInroy

(74) *Attorney, Agent, or Firm*—Hamre, Schumann, Mueller & Larson, P.C.

(57) **CLAIM**

The ornamental design for an electric oven, as shown and described.

DESCRIPTION

FIG. 1 is a perspective view of an electric oven in accordance with my invention thereof;

FIG. 2 is a front view thereof;

FIG. 3 is a left side view thereof;

FIG. 4 is a right side view thereof;

FIG. 5 is a back view thereof;

FIG. 6 is a top view thereof; and,

FIG. 7 is a bottom view thereof.

1 Claim, 7 Drawing Sheets

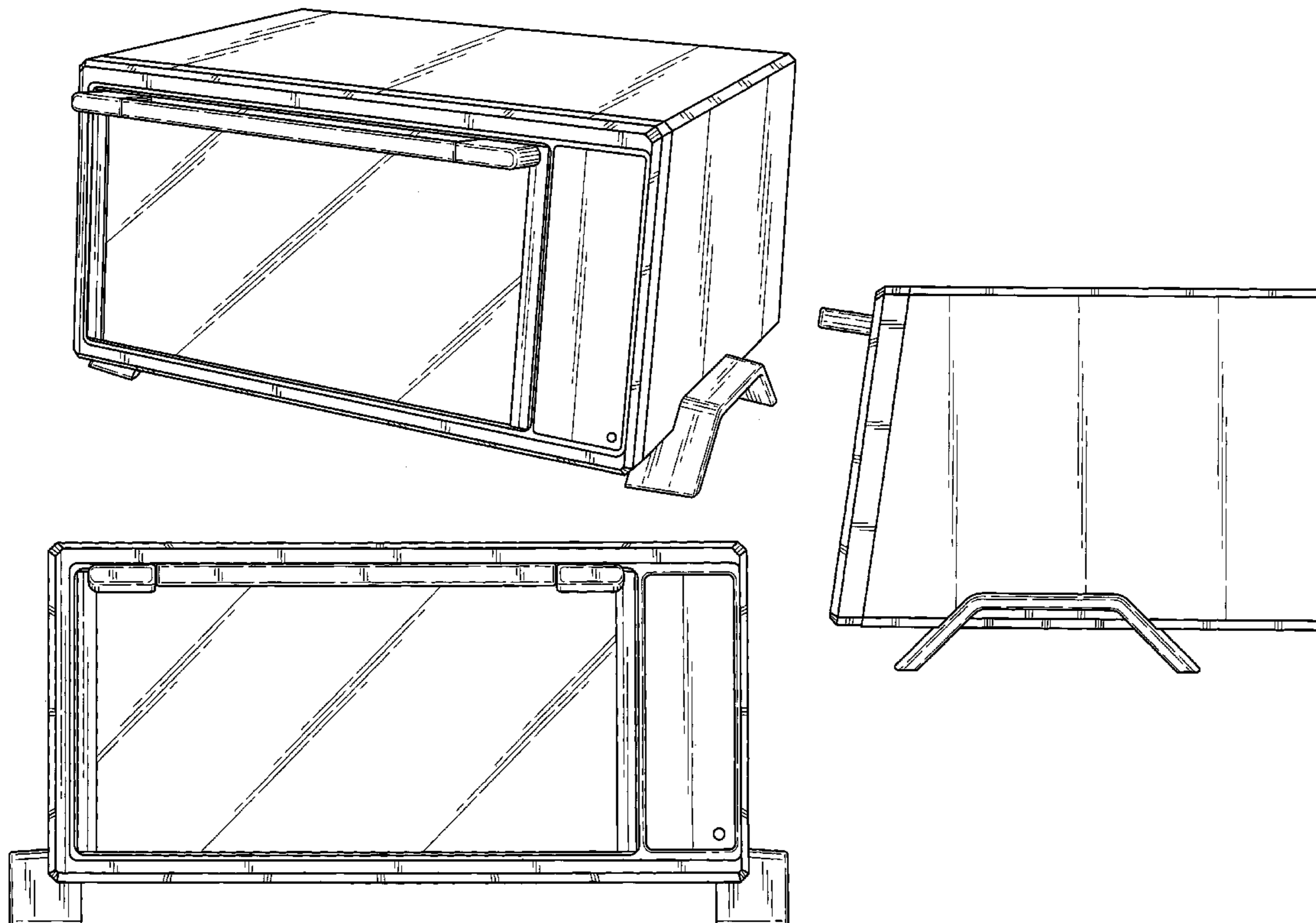

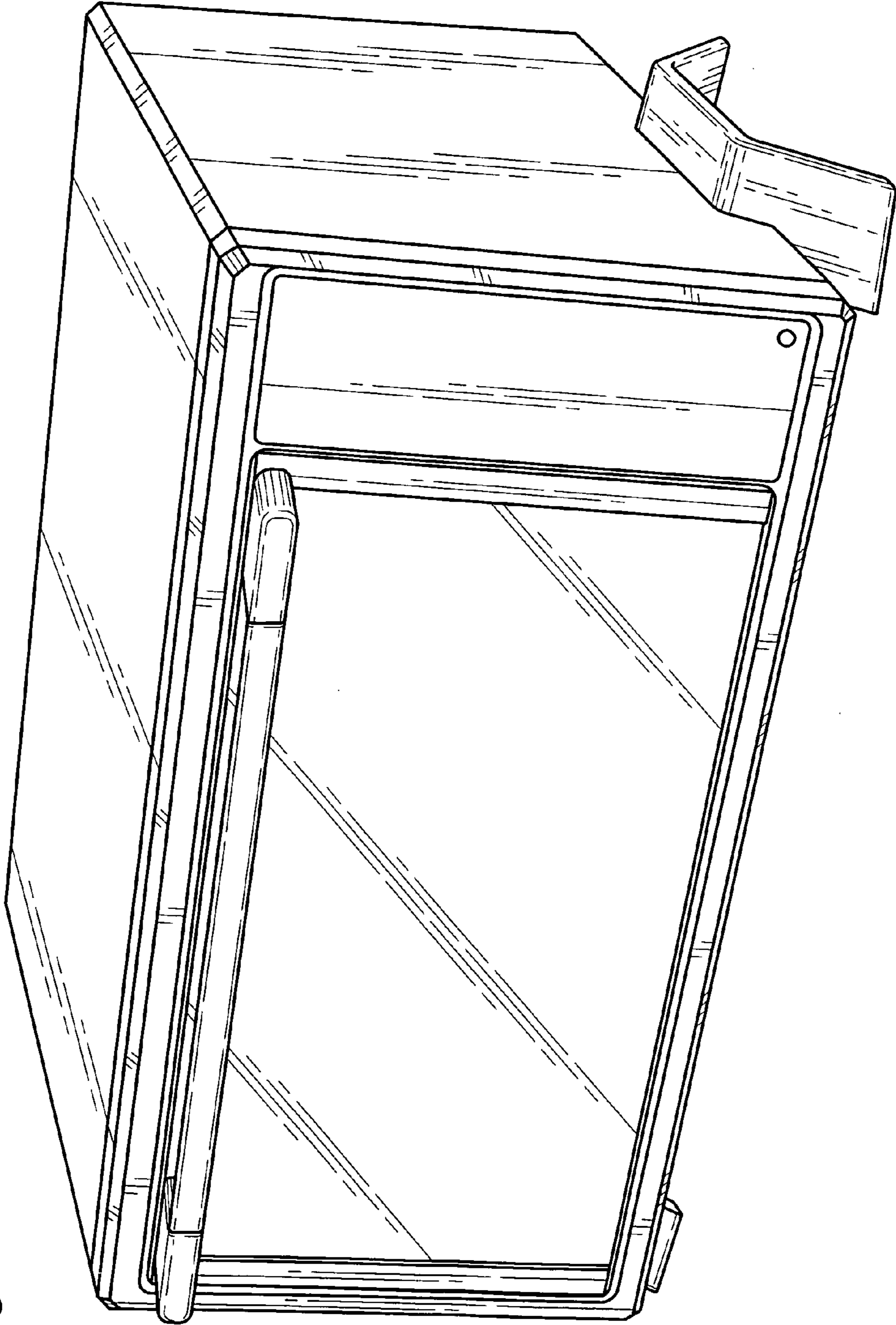

Fig. 1

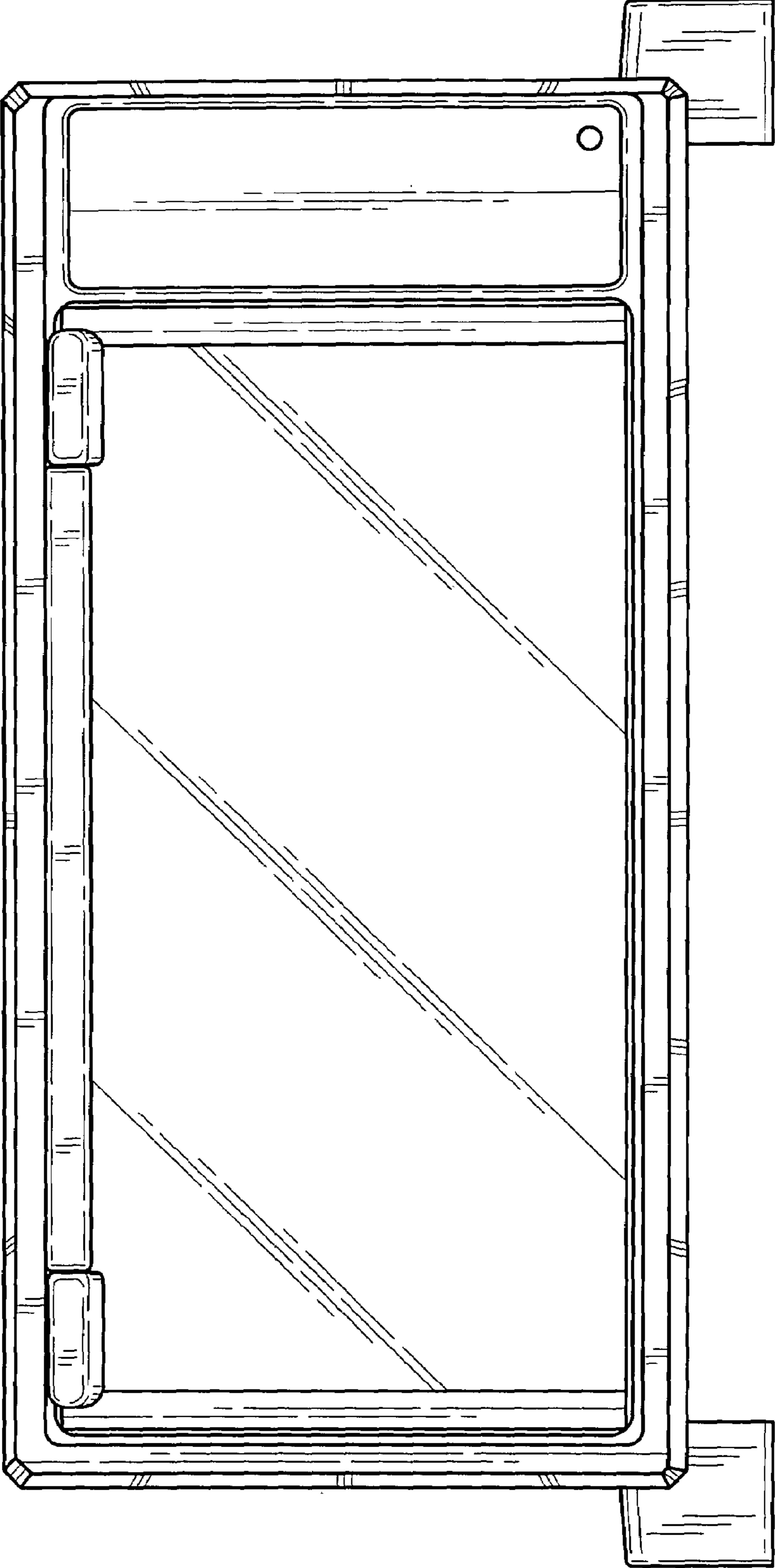

Fig. 2

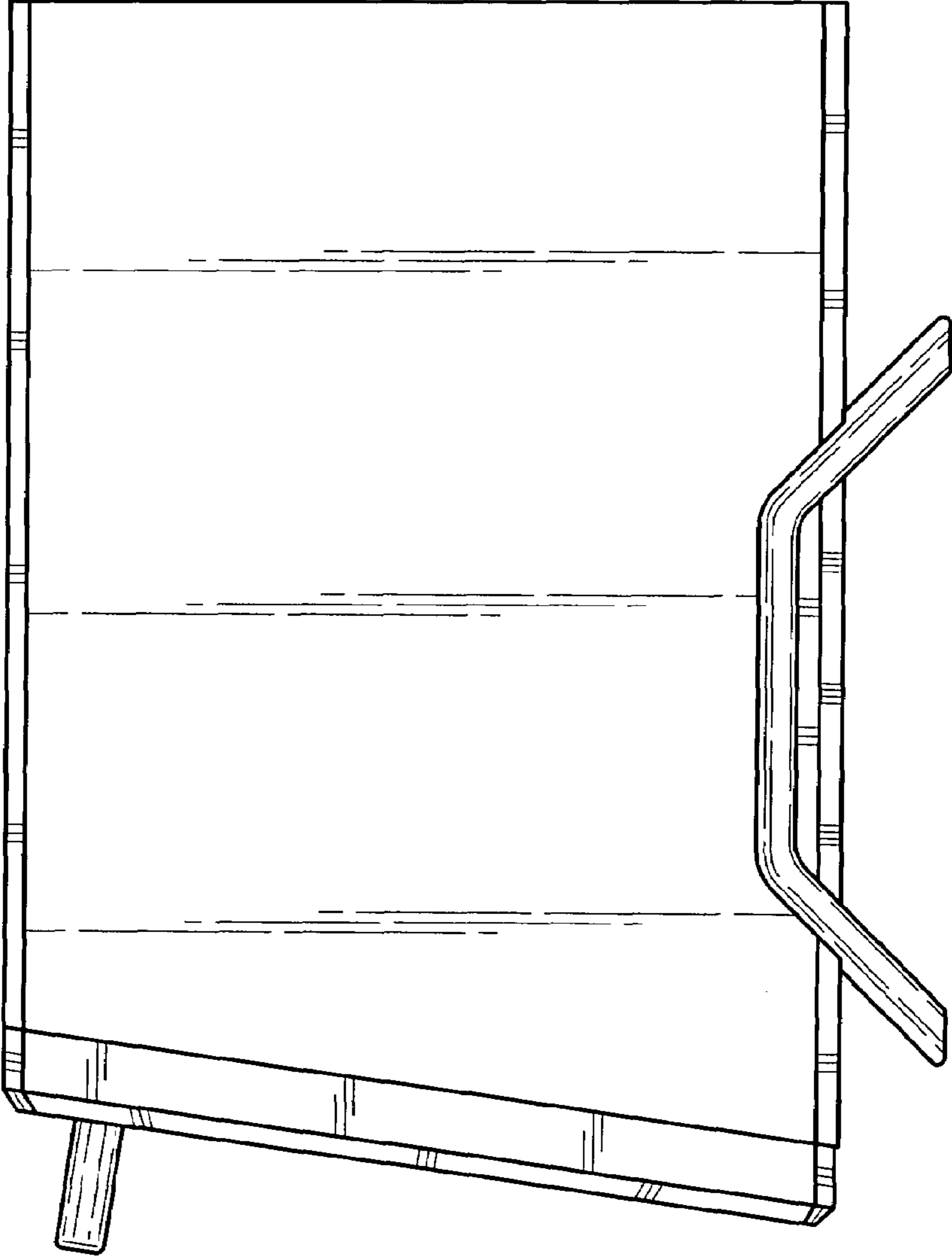

Fig. 3

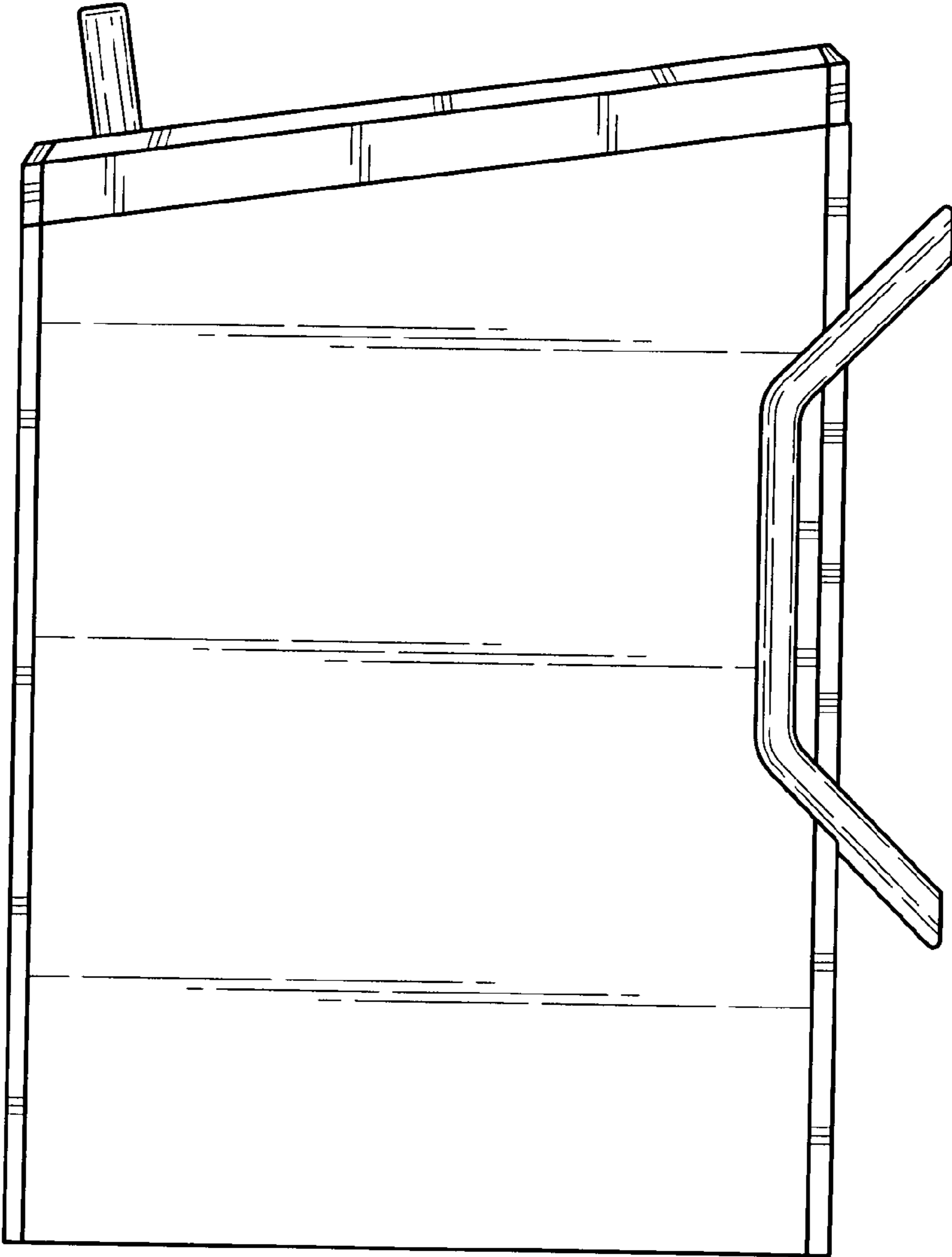

Fig. 4

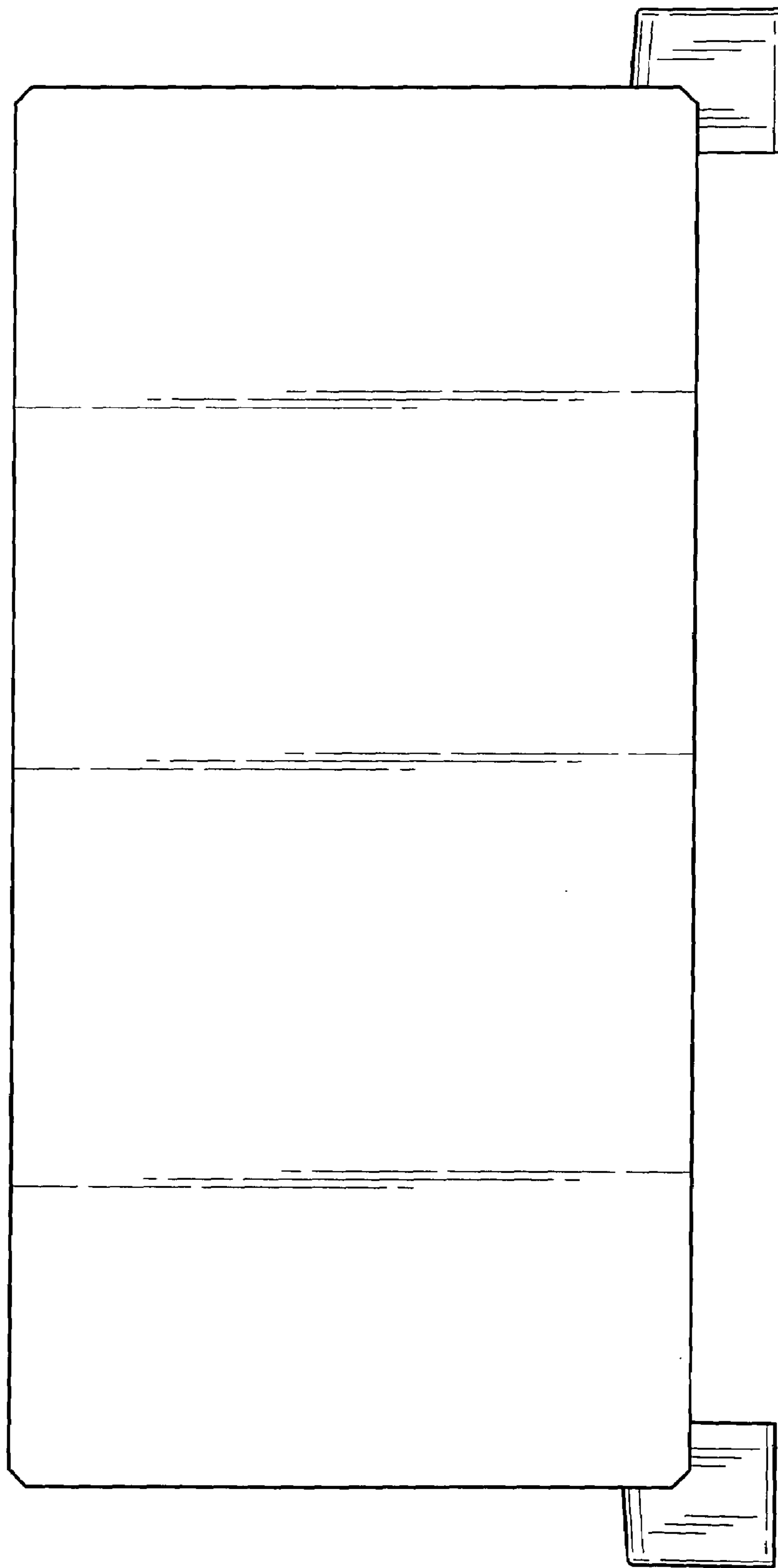

Fig. 5

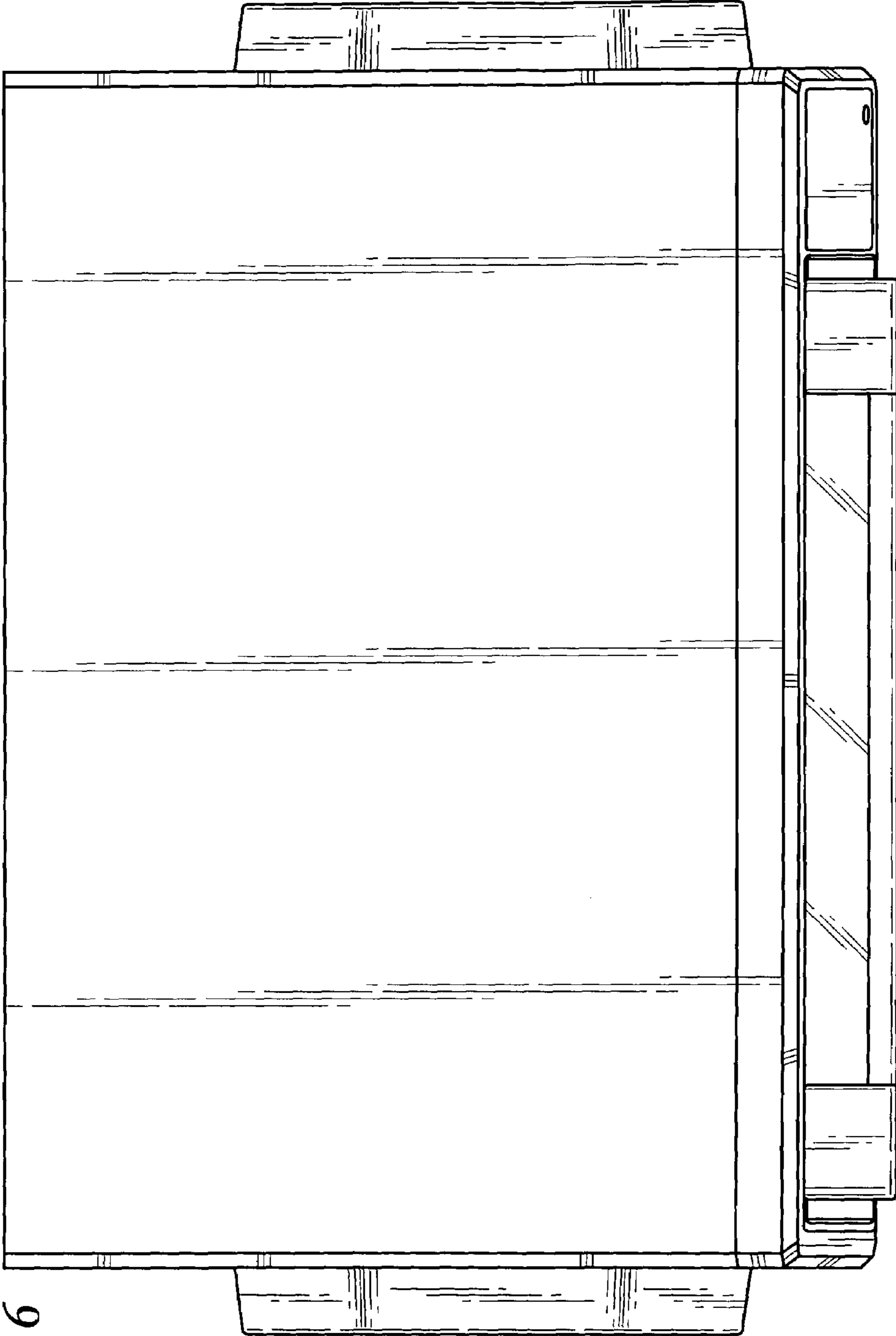

Fig. 6

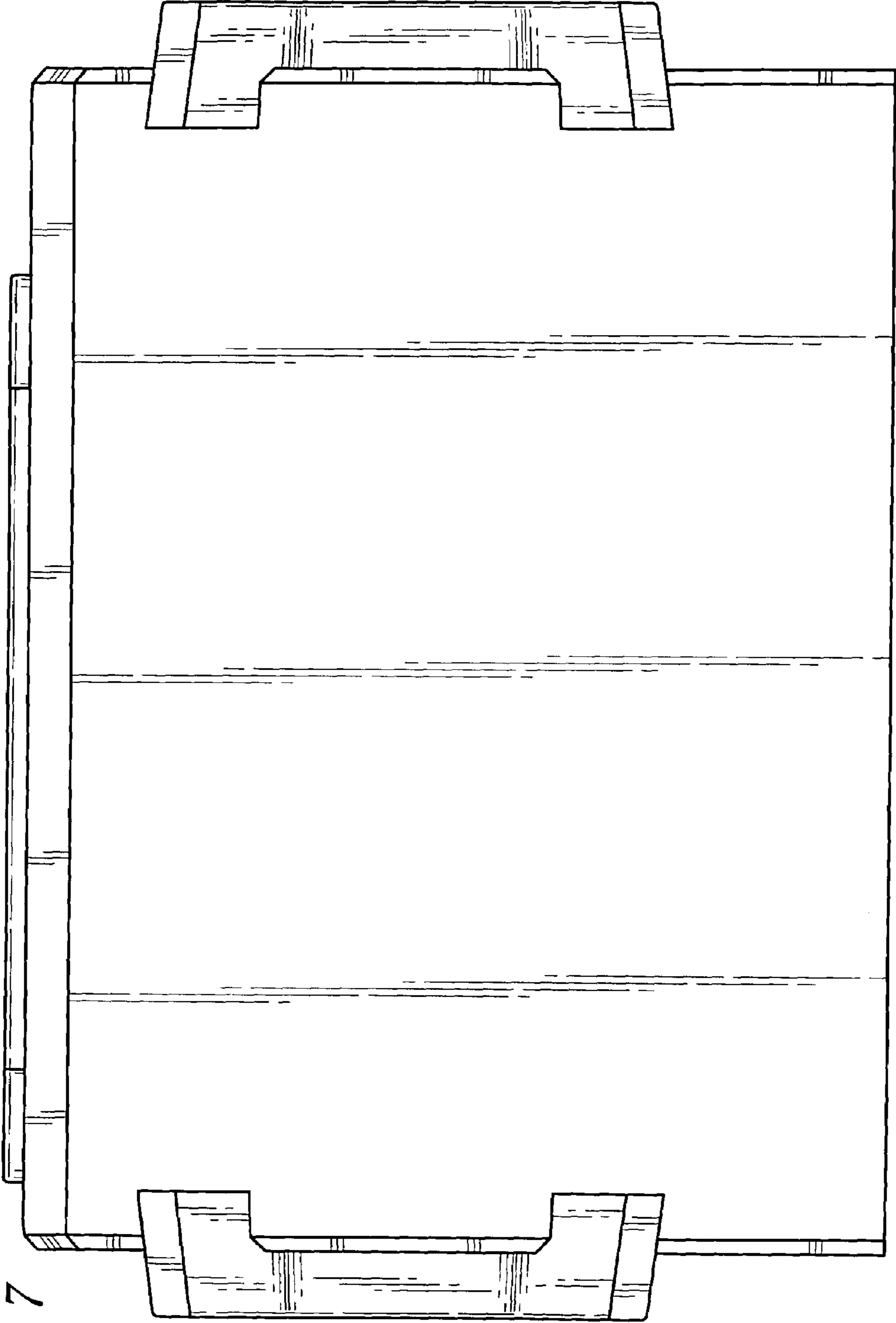

Fig. 7