



US00D575968S

(12) **United States Design Patent**  
**Saffell et al.**

(10) **Patent No.:** **US D575,968 S**  
(45) **Date of Patent:** **\*\* Sep. 2, 2008**

(54) **TABLE LEG**

(75) Inventors: **Mark Saffell**, Manhattan Beach, CA  
(US); **David Ritch**, Marina del Ray, CA  
(US)

(73) Assignee: **Krueger International, Inc.**

(\*\*) Term: **14 Years**

(21) Appl. No.: **29/280,882**

(22) Filed: **Jun. 8, 2007**

(51) **LOC (8) Cl.** ..... **06-06**

(52) **U.S. Cl.** ..... **D6/499**

(58) **Field of Classification Search** ..... D6/480-489,  
D6/495-499, 429-431, 511; 108/150, 153.1,  
108/155, 156, 161; 248/188, 188.1, 188.8,  
248/188.9

See application file for complete search history.

(56) **References Cited**

**U.S. PATENT DOCUMENTS**

D134,388 S	*	11/1942	Waltman	.....	D6/461
D186,896 S	*	12/1959	Monroe	.....	D6/495
D289,117 S	*	4/1987	Schmid	.....	D6/484
D352,853 S	*	11/1994	Hosoe	.....	D6/482
D444,969 S	*	7/2001	Erickson et al.	.....	D6/495
D456,183 S	*	4/2002	Brown	.....	D6/495
D471,791 S		3/2003	Bosman		
D488,998 S		4/2004	Bosman		
D517,843 S		3/2006	Barefoot		
D519,305 S		4/2006	Pesso		

\* cited by examiner

*Primary Examiner*—Janice E Seeger

(74) *Attorney, Agent, or Firm*—Boyle Fredrickson, S.C.

(57) **CLAIM**

The ornamental design of a table leg, as shown and described.

**DESCRIPTION**

FIG. 1 is an isometric view of a table leg incorporating our new design, wherein the portions in phantom indicate environment and form no part of the claimed design, and also indicate indeterminate length;

FIG. 2 is an enlarged isometric view thereof, wherein the portions in phantom again indicate environment and form no part of the claimed design, and also indicate indeterminate length;

FIG. 3 is a right side elevation view thereof, the left side elevation view being a mirror image;

FIG. 4 is a front elevation view thereof;

FIG. 5 is a rear elevation view thereof;

FIG. 6 is a top plan view thereof;

FIG. 7 is a bottom plan view thereof;

FIG. 8 is a view similar to FIG. 1 showing another embodiment of a table leg incorporating our new design, wherein the portions in phantom indicate environment and form no part of the claimed design, and also indicate indeterminate length;

FIG. 9 is an enlarged isometric view thereof, wherein the portions in phantom again indicate environment and form no part of the claimed design, and also indicate indeterminate length;

FIG. 10 is a side elevation view thereof;

FIG. 11 is a top plan view thereof; and,

FIG. 12 is a bottom plan view thereof.

**1 Claim, 7 Drawing Sheets**

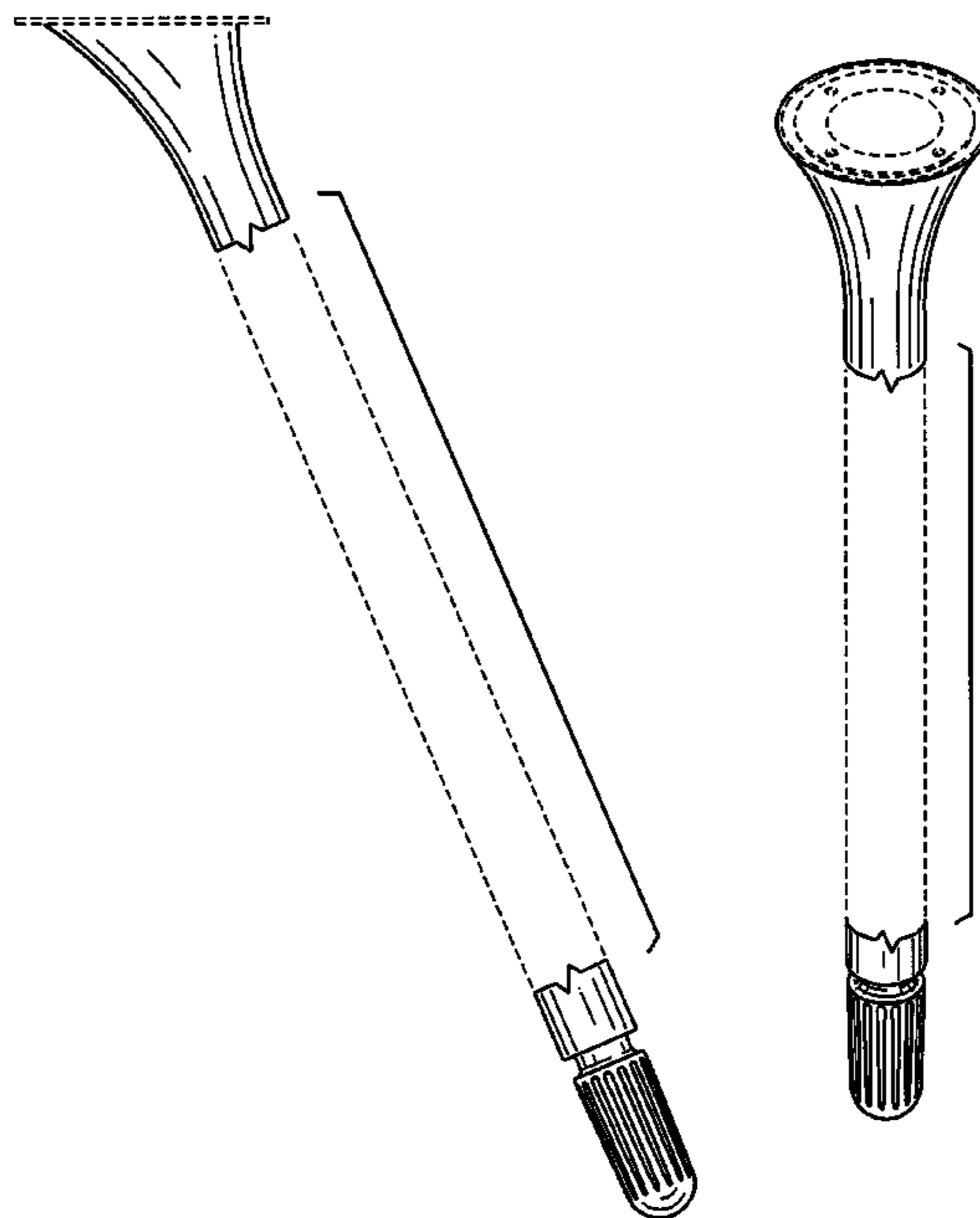

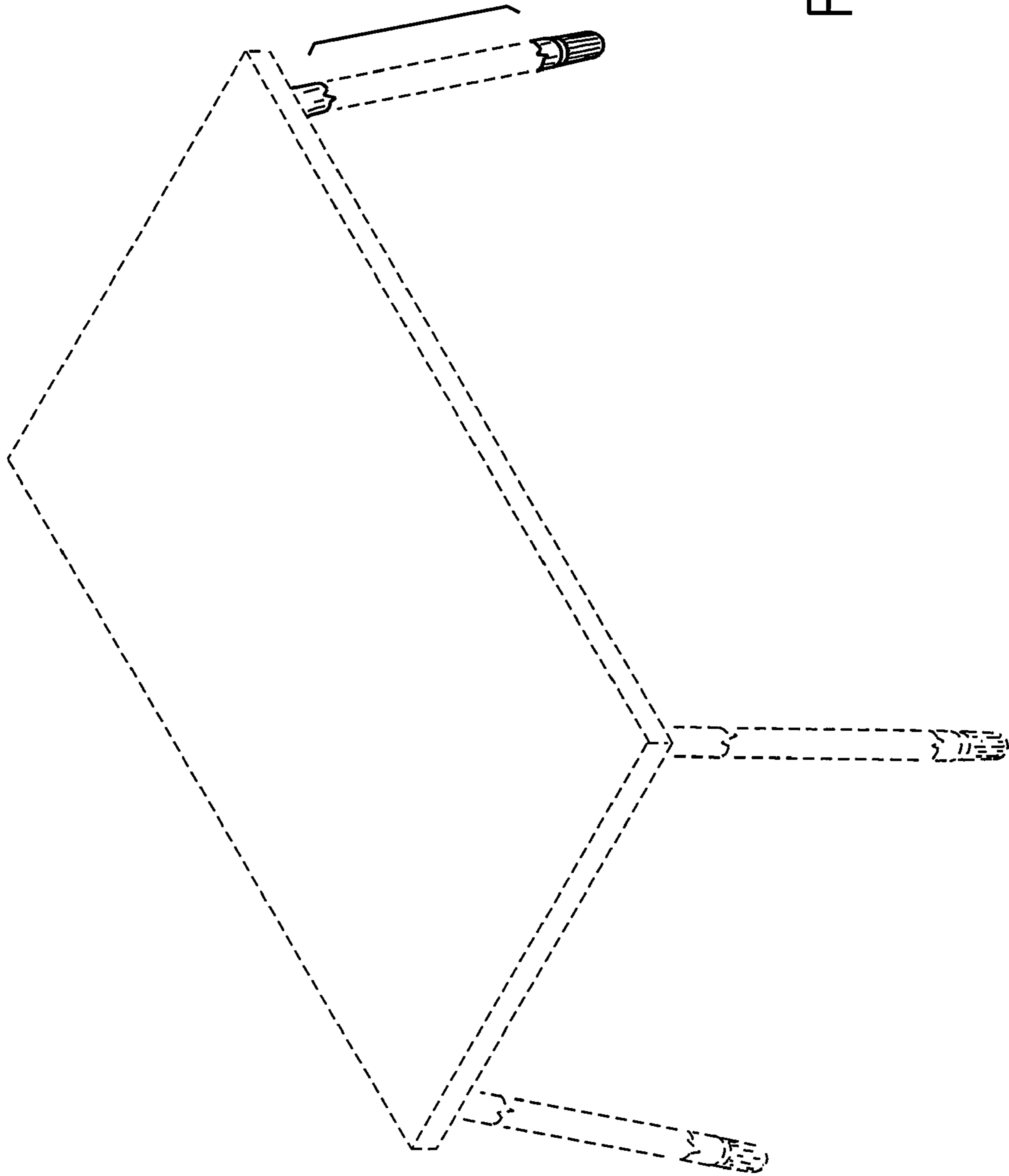
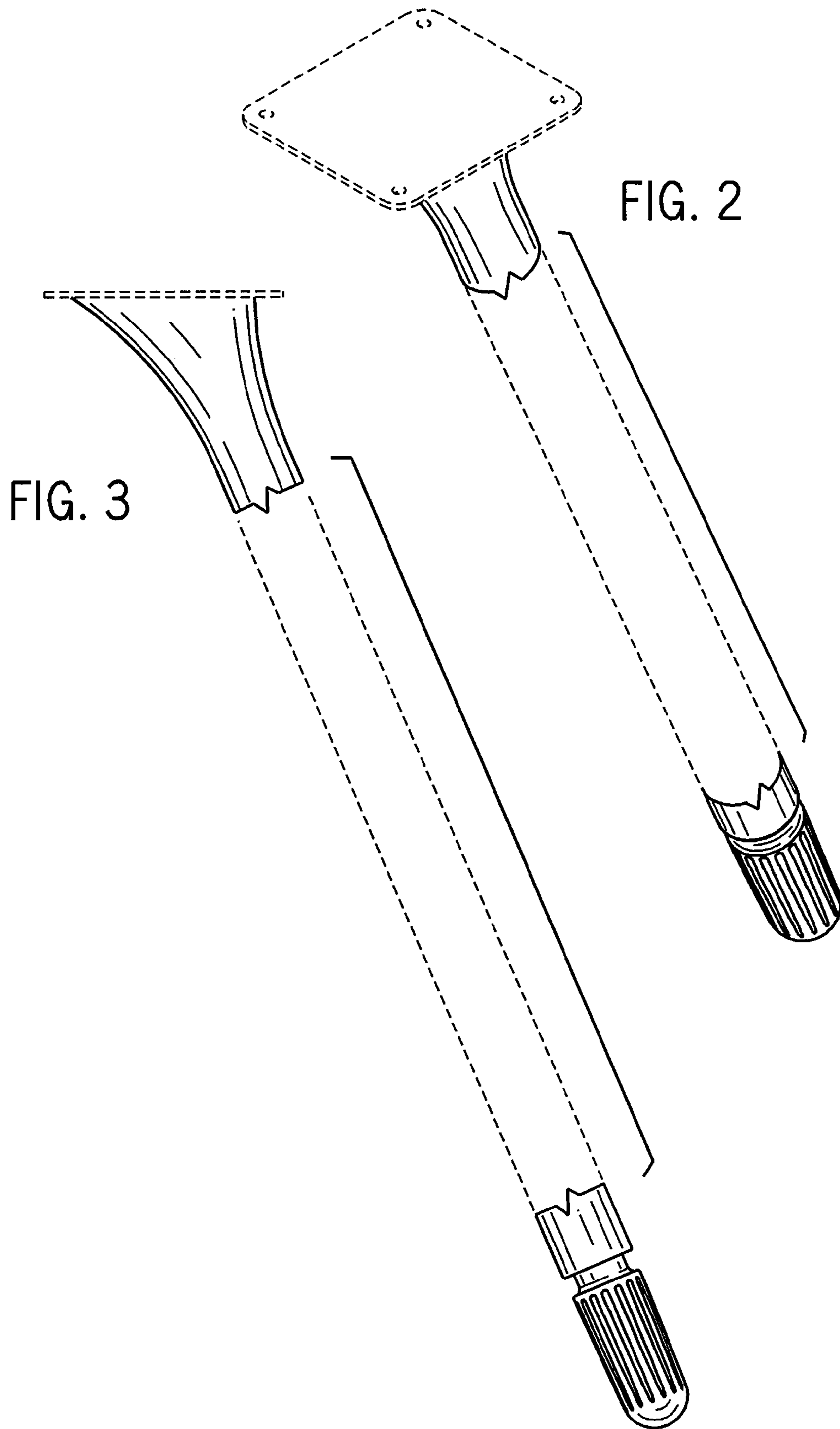

FIG. 1



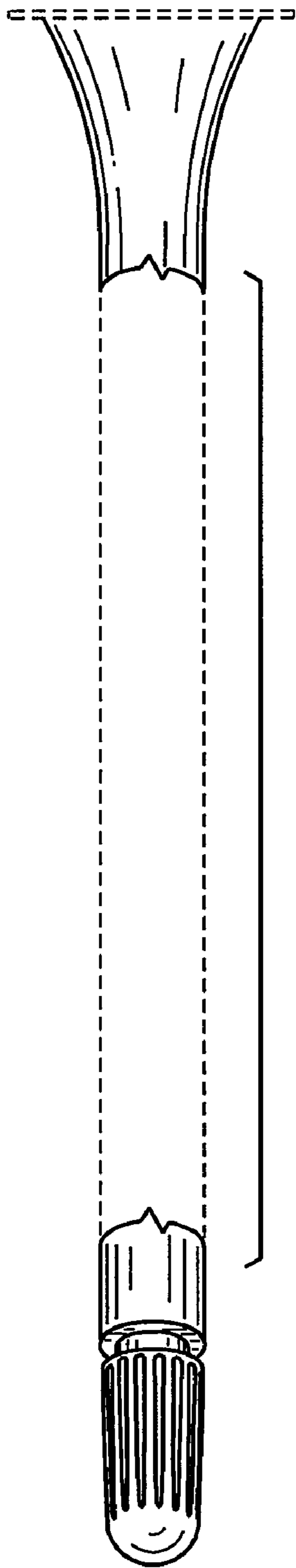

FIG. 4

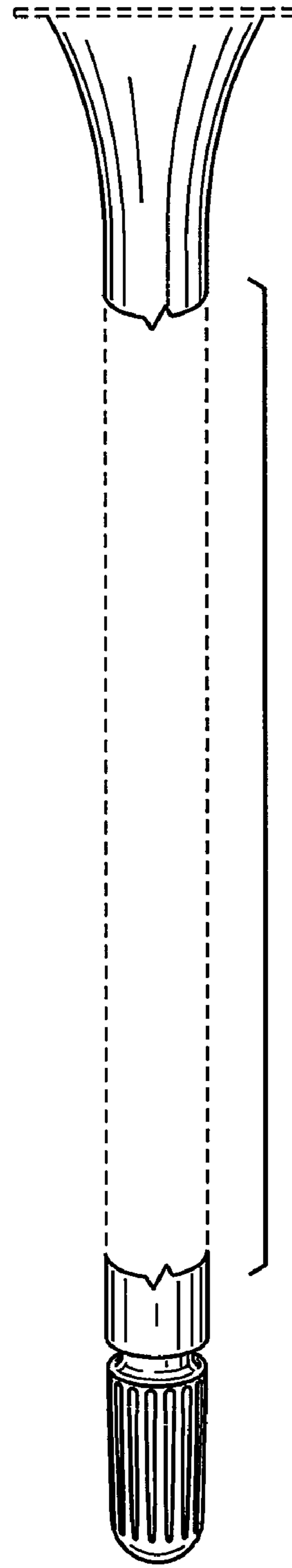

FIG. 5

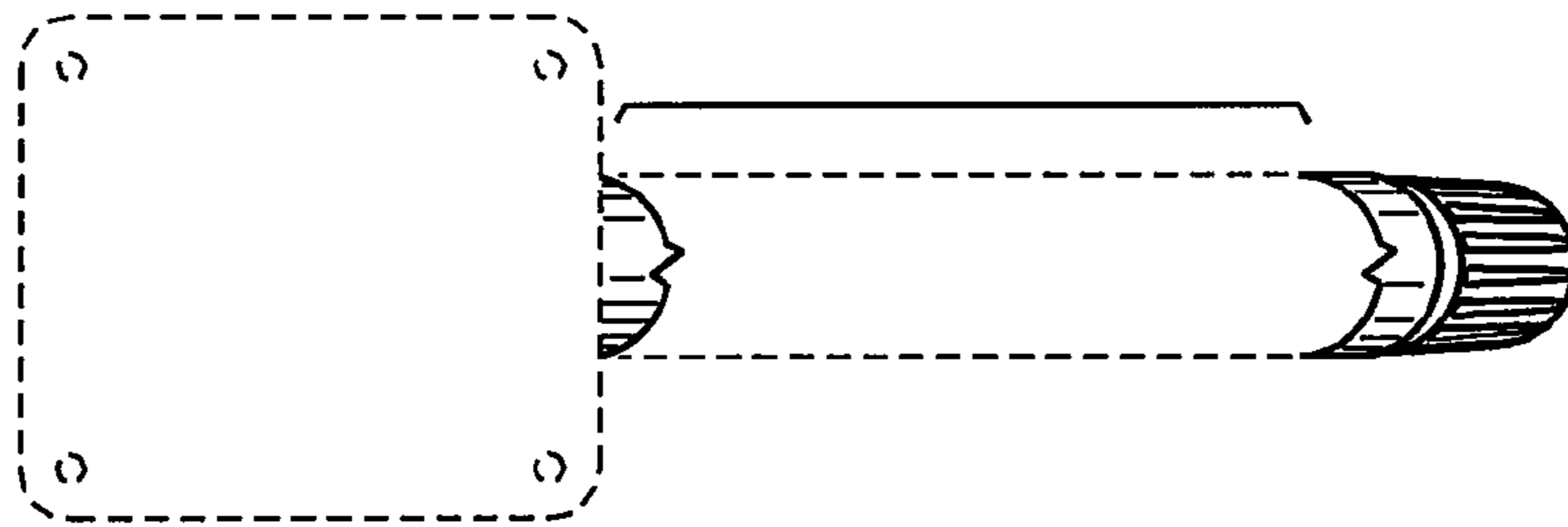

FIG. 6

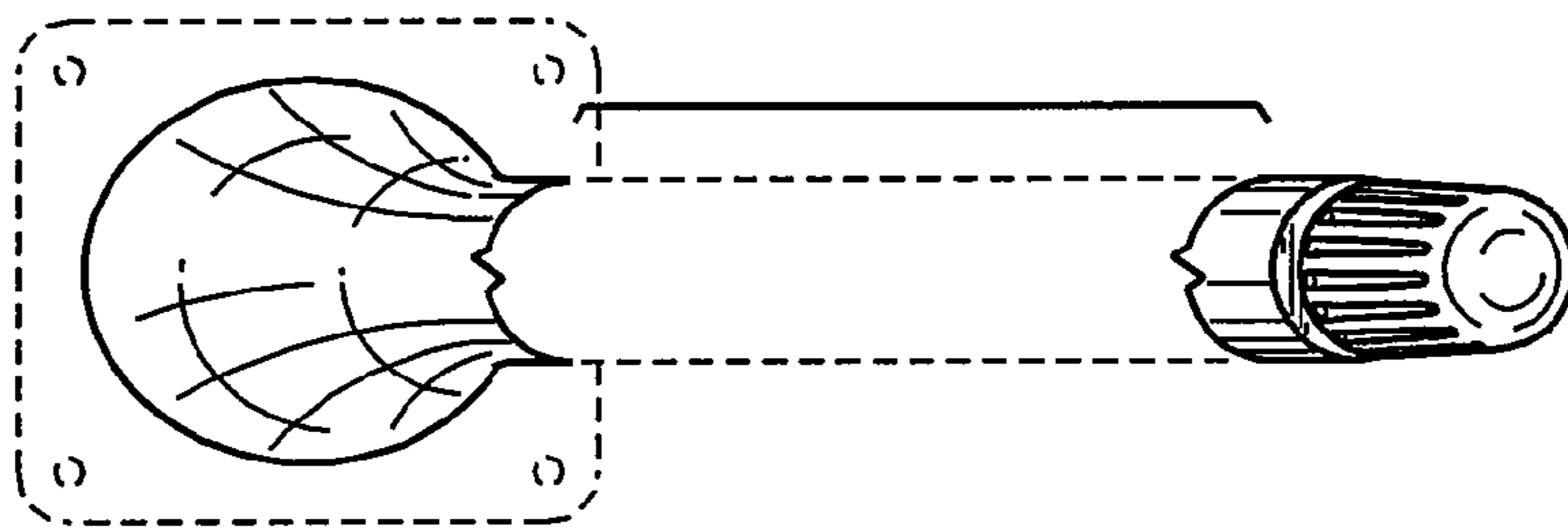

FIG. 7

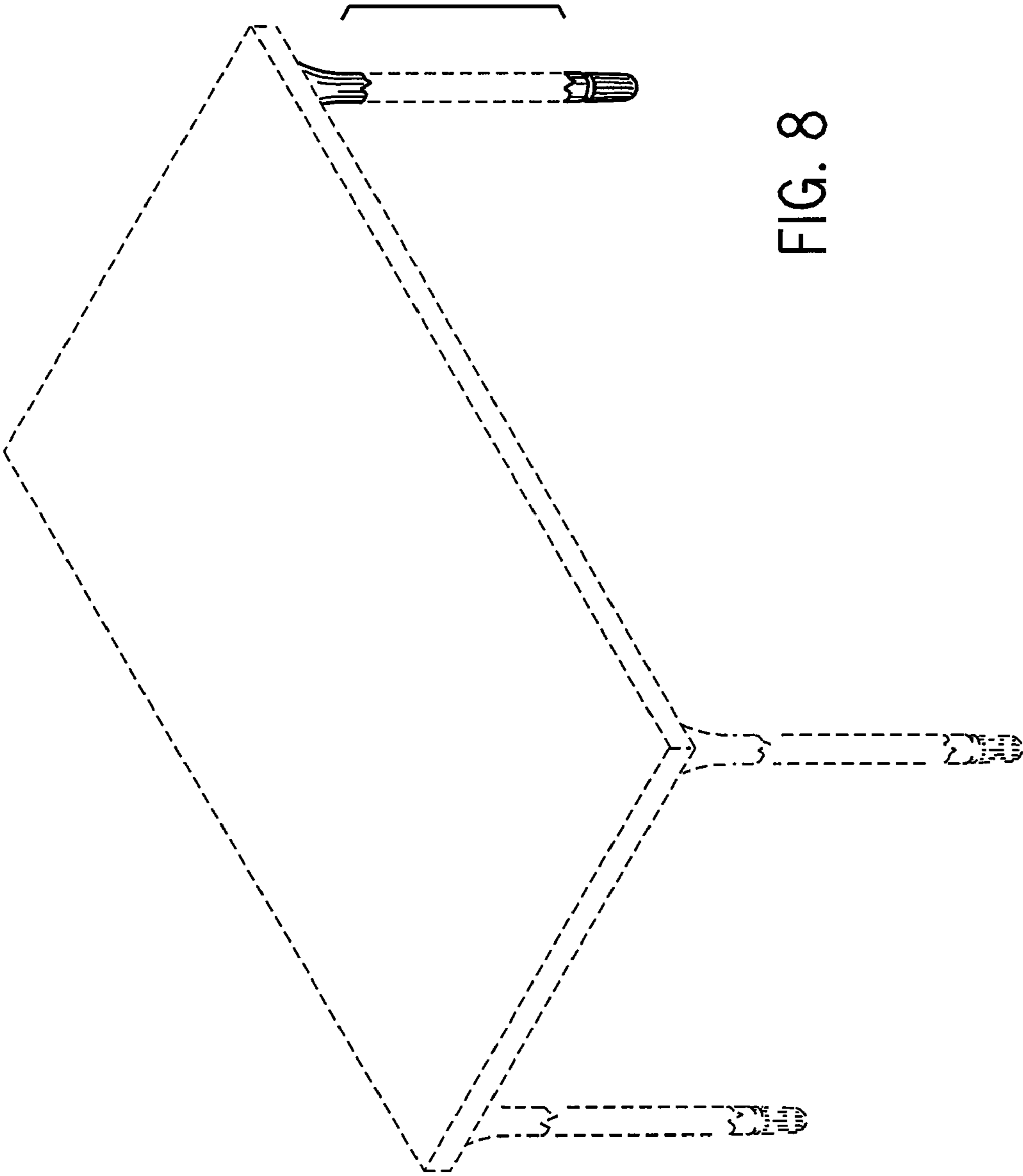

FIG. 8

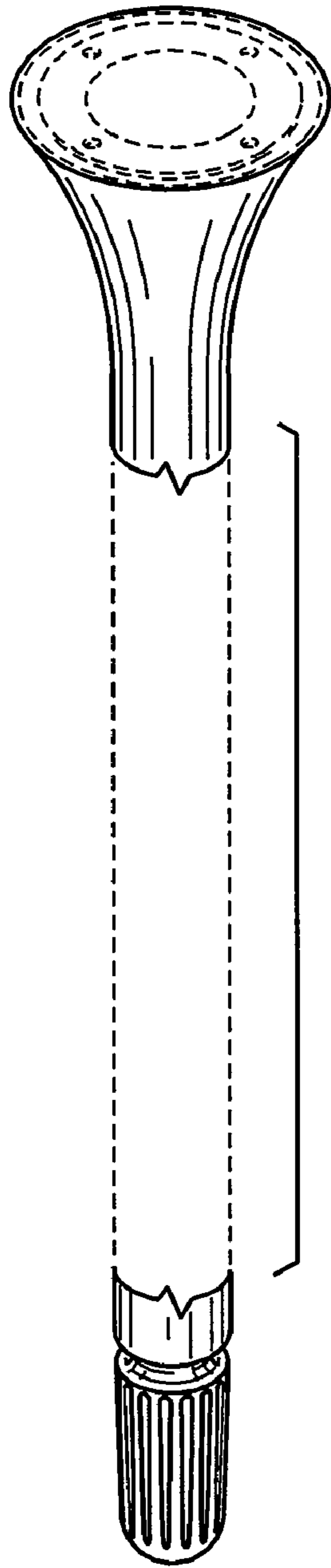

FIG. 9

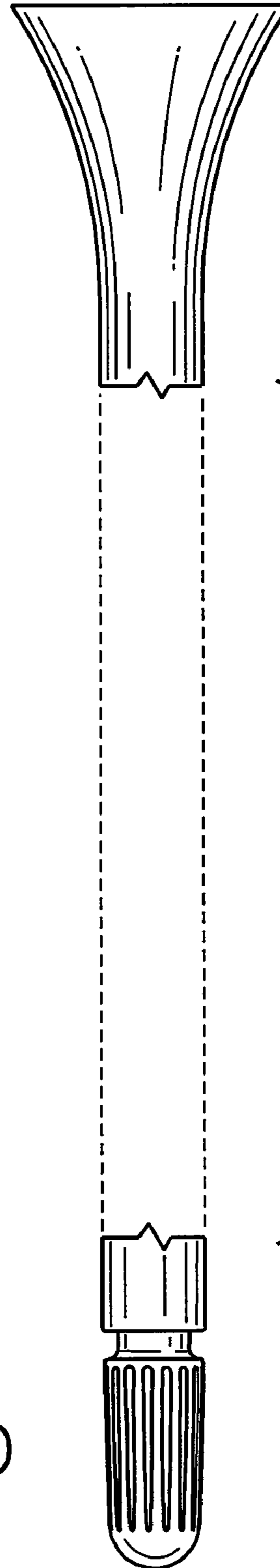

FIG. 10

FIG. 11

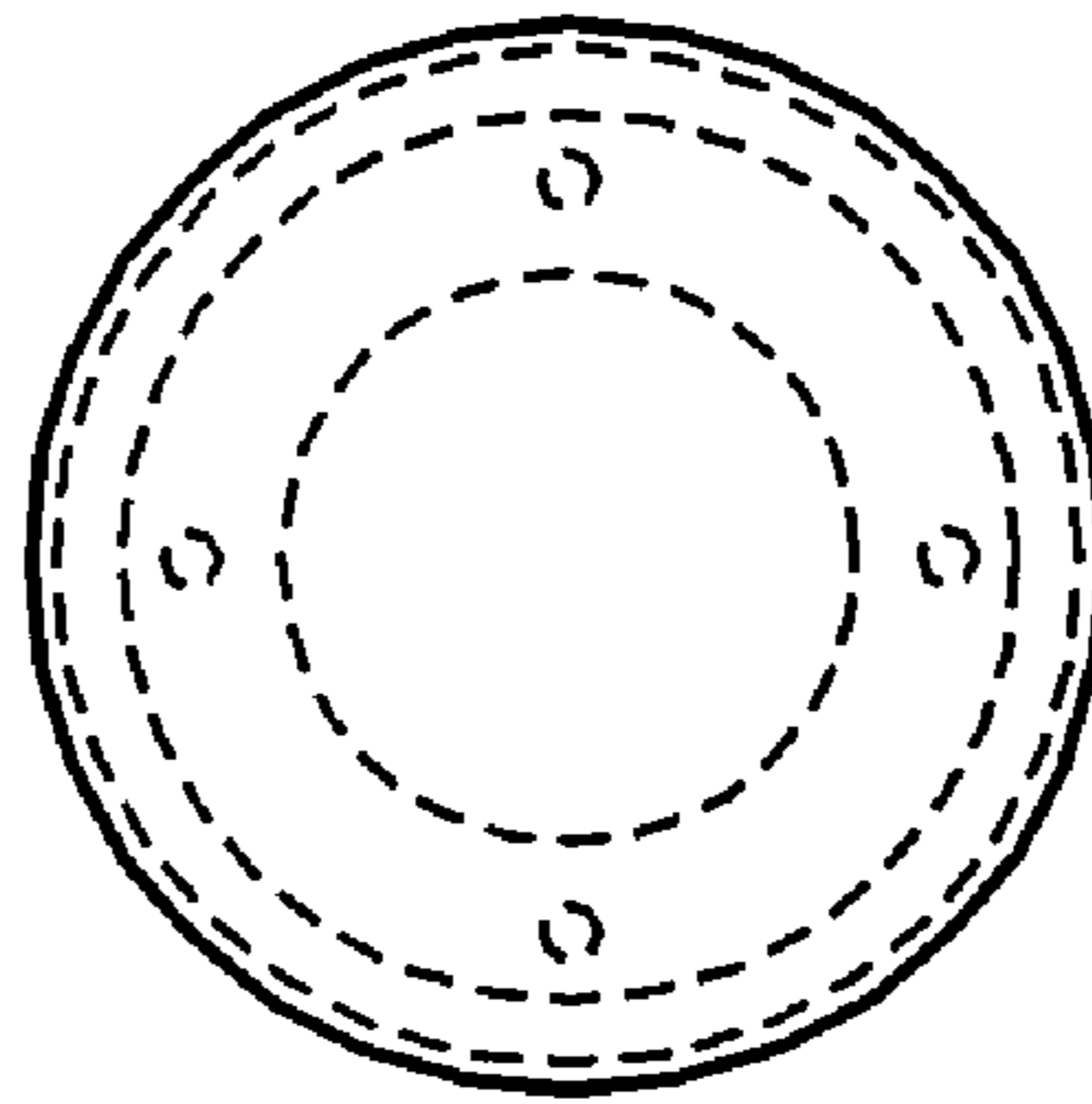

FIG. 12

