



US00D575947S

(12) **United States Design Patent**  
**Minami**

(10) **Patent No.:** **US D575,947 S**  
(45) **Date of Patent:** **\*\* Sep. 2, 2008**

(54) **SHOE UPPER**

(75) Inventor: **Tetsuya T. Minami**, Portland, OR (US)

(73) Assignee: **Nike, Inc.**, Beaverton, OR (US)

(\*\*) Term: **14 Years**

(21) Appl. No.: **29/280,917**

(22) Filed: **Jun. 8, 2007**

(51) **LOC (8) Cl.** ..... **02-99**

(52) **U.S. Cl.** ..... **D2/969**

(58) **Field of Classification Search** ..... D2/902,  
D2/906-908, 943, 944, 969, 972-974, 945;  
36/45, 77 M, 77 R, 83, 113, 114, 126-131  
See application file for complete search history.

(56) **References Cited**

**U.S. PATENT DOCUMENTS**

D296,613 S	7/1988	Brown	
D310,292 S	9/1990	Selbiger	
D314,858 S	2/1991	Richard	
D336,973 S	7/1993	Fritcher	
D373,456 S	9/1996	Gibson	
D398,769 S	9/1998	Avar	
D421,834 S	3/2000	Cooper	
D450,425 S	11/2001	Bosse et al.	
D458,443 S	6/2002	Matis	
D459,870 S	7/2002	St. Louis	
D472,041 S	3/2003	Kuerbis	
D475,847 S *	6/2003	Schroeder et al.	D2/972
D480,540 S	10/2003	Hoyt et al.	
D500,584 S *	1/2005	Link	D2/972
D512,815 S	12/2005	Stauffer	
D513,836 S	1/2006	Magro et al.	
D515,287 S *	2/2006	Ardissono	D2/907
D520,719 S	5/2006	Della Valle	
D528,761 S	9/2006	Kayano	
D528,770 S	9/2006	Chang	
D536,866 S	2/2007	Cass	
D544,685 S	6/2007	Mermet	

D545,050 S	6/2007	Shaffer	
D548,946 S	8/2007	Harlow	
D548,950 S	8/2007	Holmes	
D549,937 S	9/2007	Matis et al.	
D550,429 S *	9/2007	Rohwer-Kahlmann	D2/902
D561,448 S *	2/2008	Hickman	D2/969
D561,449 S *	2/2008	James	D2/969
D564,210 S *	3/2008	Minami	D2/972

**OTHER PUBLICATIONS**

Nike Footwear Catalog, Spring 1992, p. 94, published May 1991.  
 Nike Footwear Catalog, Late Spring 1996, pp. 96 and 121, published Aug. 1995.  
 Nike Footwear Catalog, Spring 2000 (#1), p. 83M, published Jul. 1999.  
 Nike Footwear Catalog, Fall 2002, p. 112M, published Nov. 2001.  
 Nike Footwear Catalog, Fall 2003, p. 85, published Nov. 2002.  
 Nike Footwear Catalog, Holiday 2003, pp. 69M and 90, published Mar. 2003.  
 Nike Footwear Catalog, Late Spring 2004, p. 97M, published Sep. 2003.  
 Nike Footwear Catalog, Holiday 2005, p. 143, published Mar. 2005.

\* cited by examiner

*Primary Examiner*—Dominic Simone  
(74) *Attorney, Agent, or Firm*—Banner & Witcoff, Ltd.

(57) **CLAIM**

The ornamental design for a shoe upper, as shown and described.

**DESCRIPTION**

FIG. 1 is a front perspective view of a shoe upper showing my new design;  
 FIG. 2 is a front view thereof;  
 FIG. 3 is a rear view thereof;  
 FIG. 4 is a side view thereof;  
 FIG. 5 is a second side view thereof; and,  
 FIG. 6 is a top view thereof.

**1 Claim, 5 Drawing Sheets**

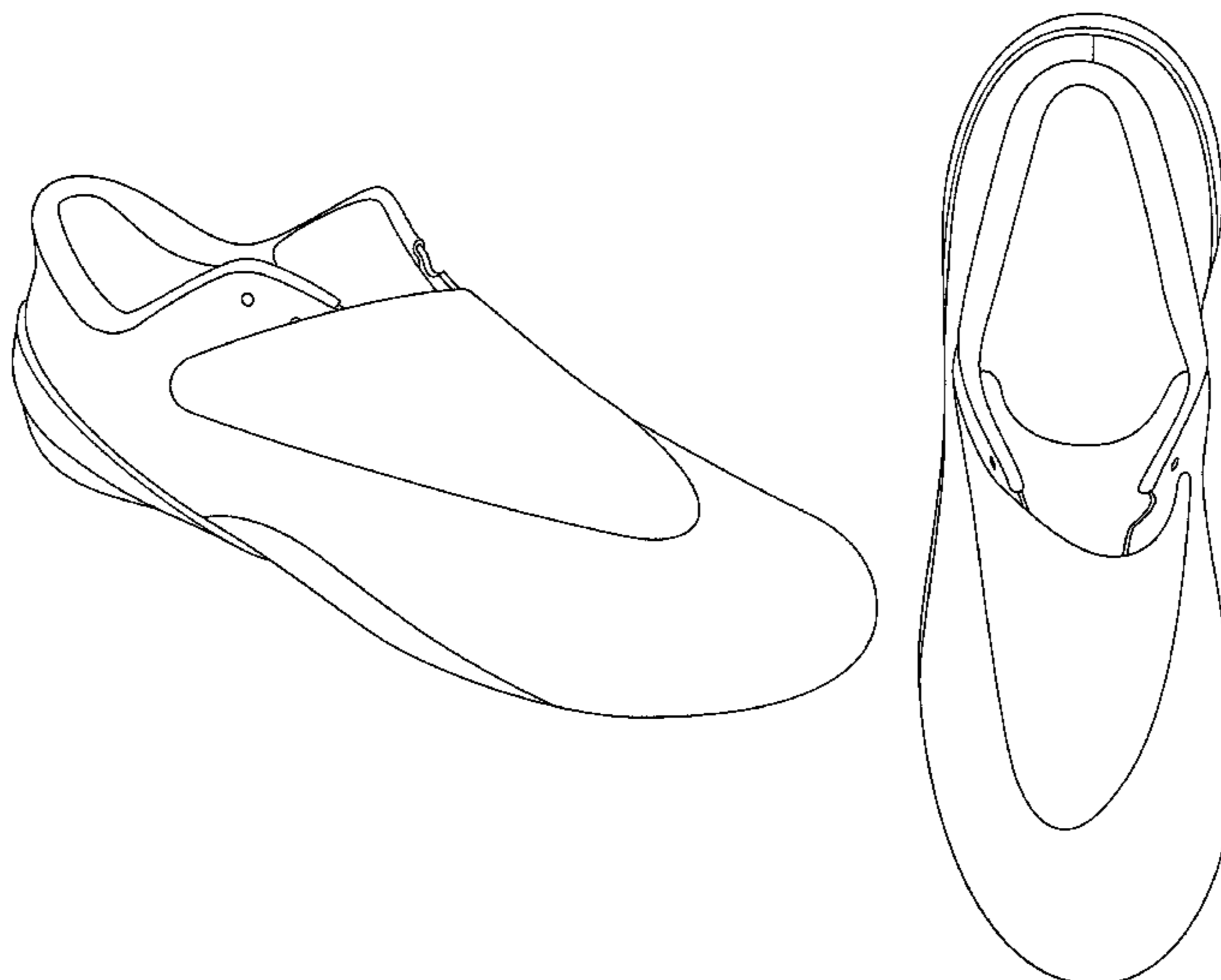

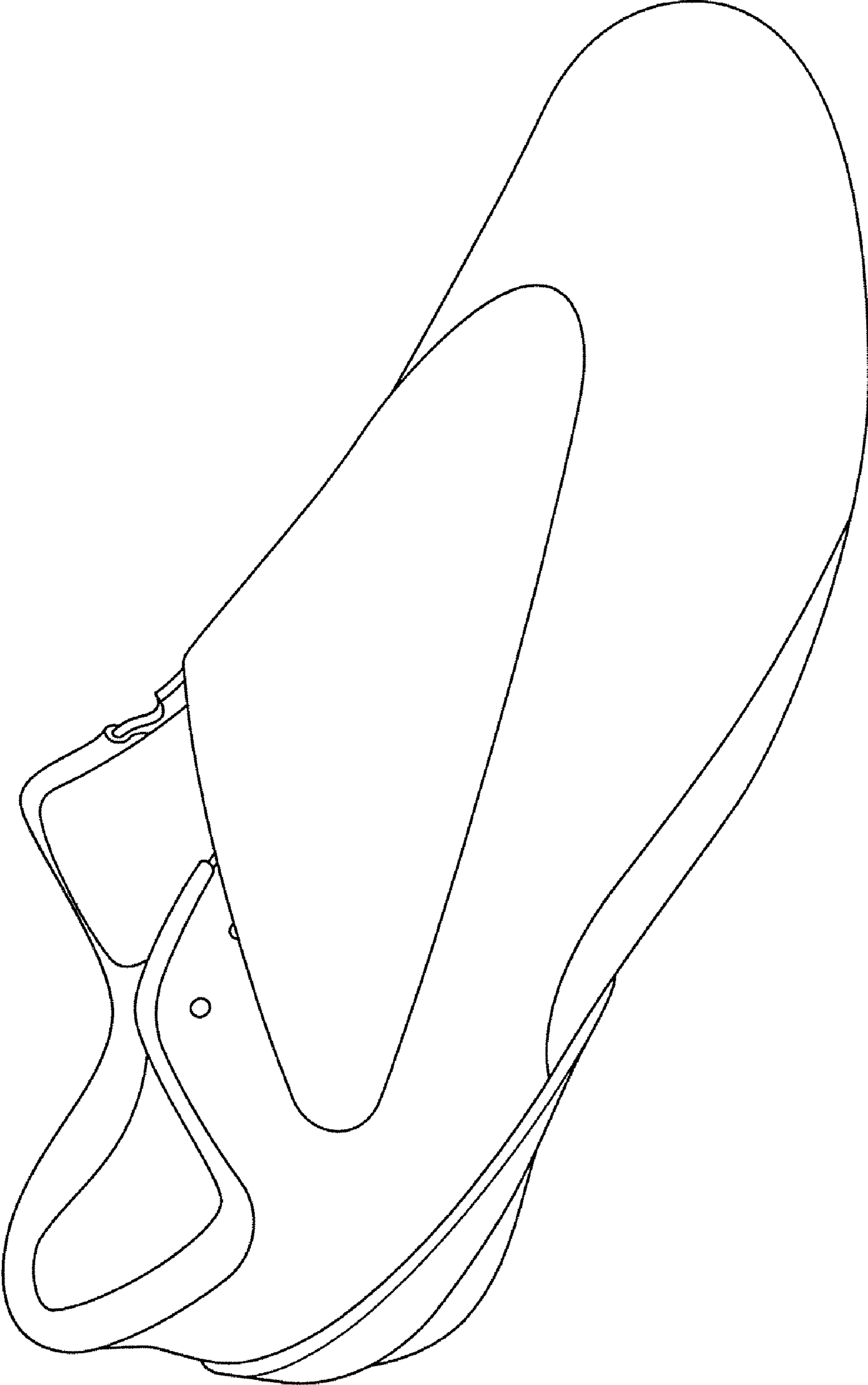

FIG. 1

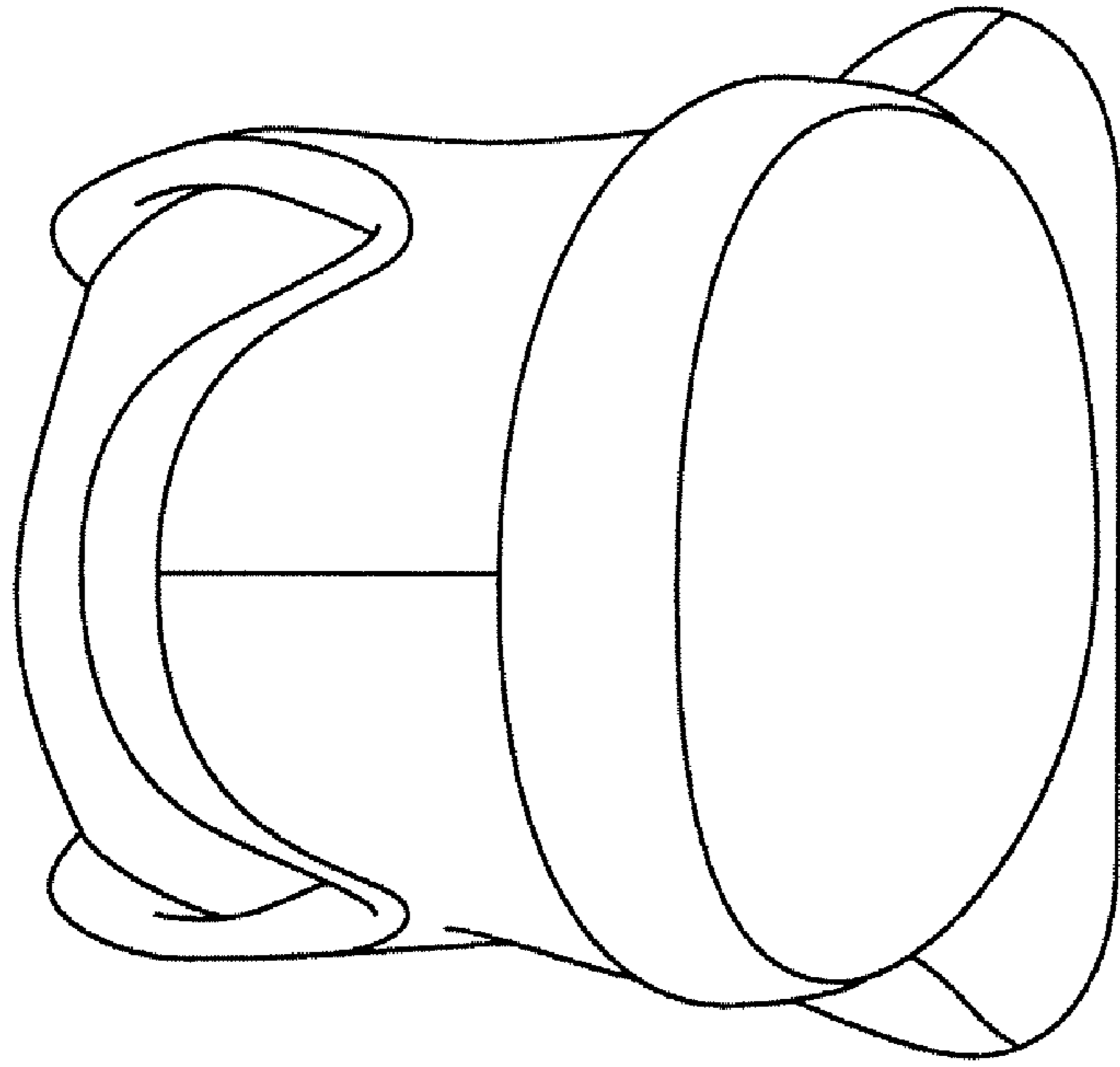

FIG. 3

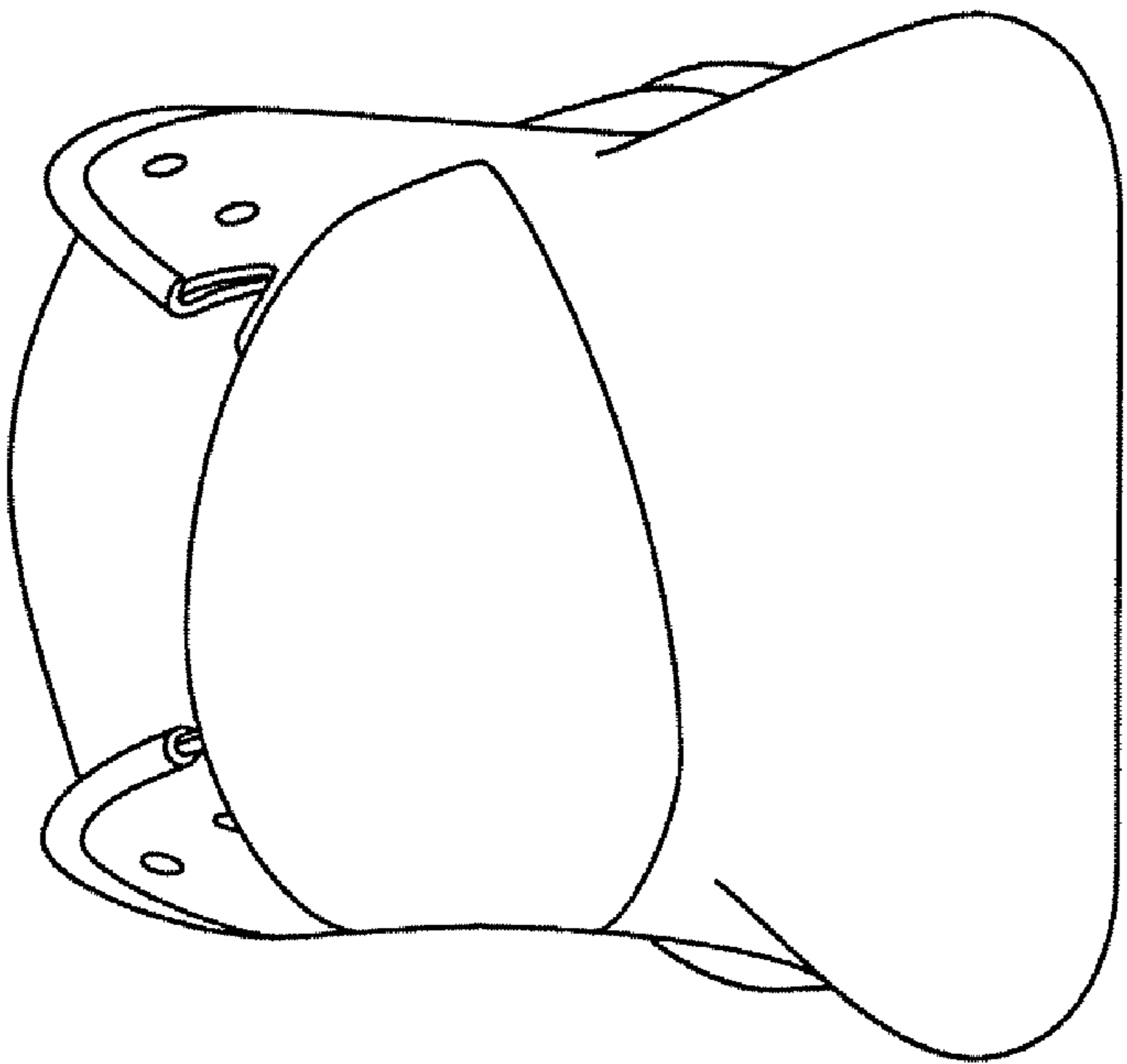

FIG. 2

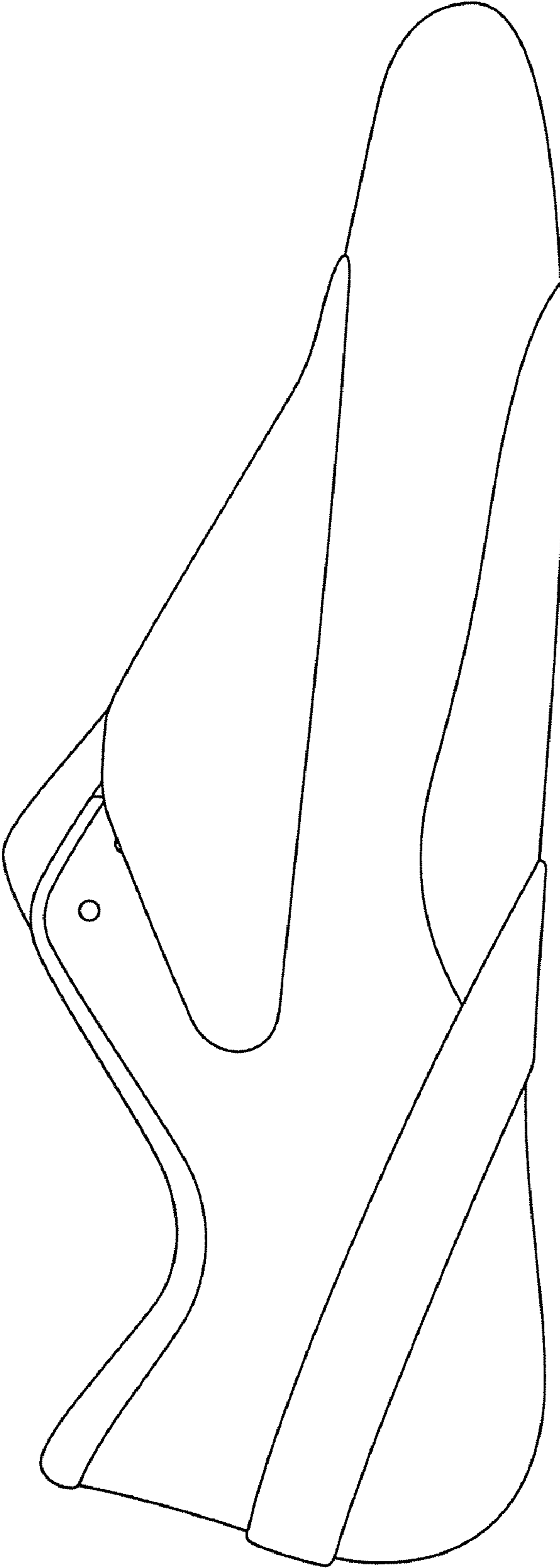

FIG. 4

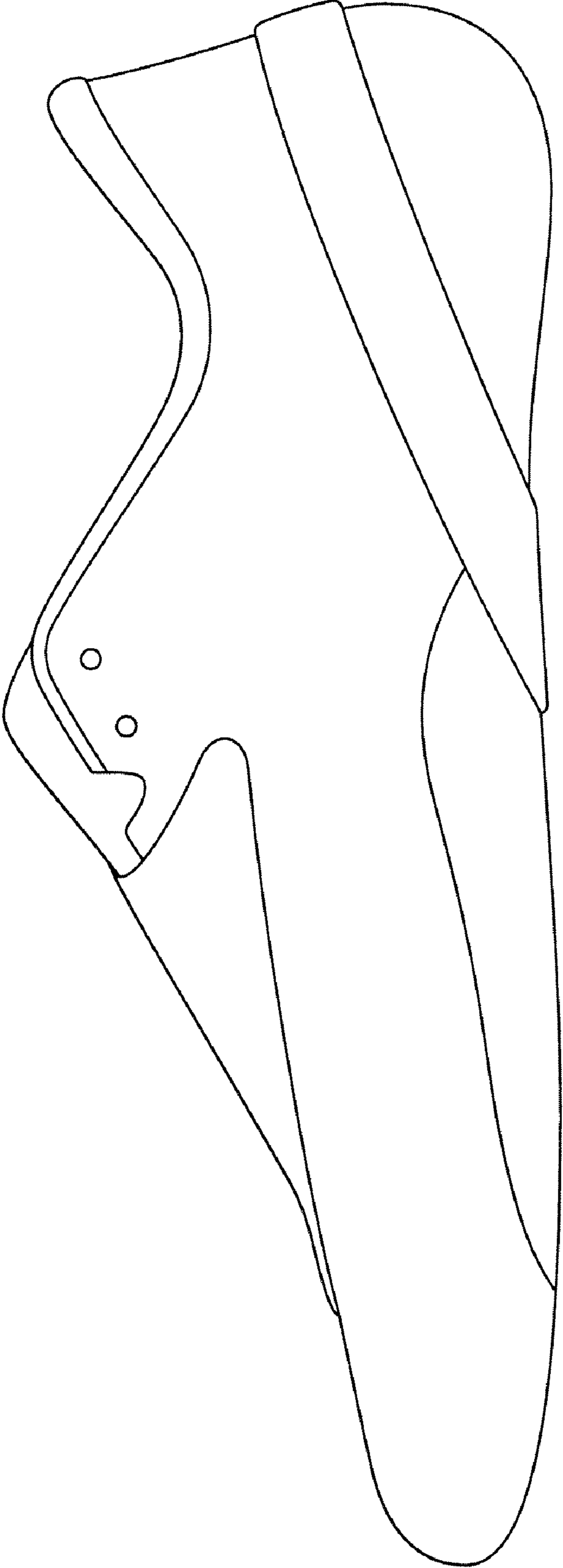

FIG. 5

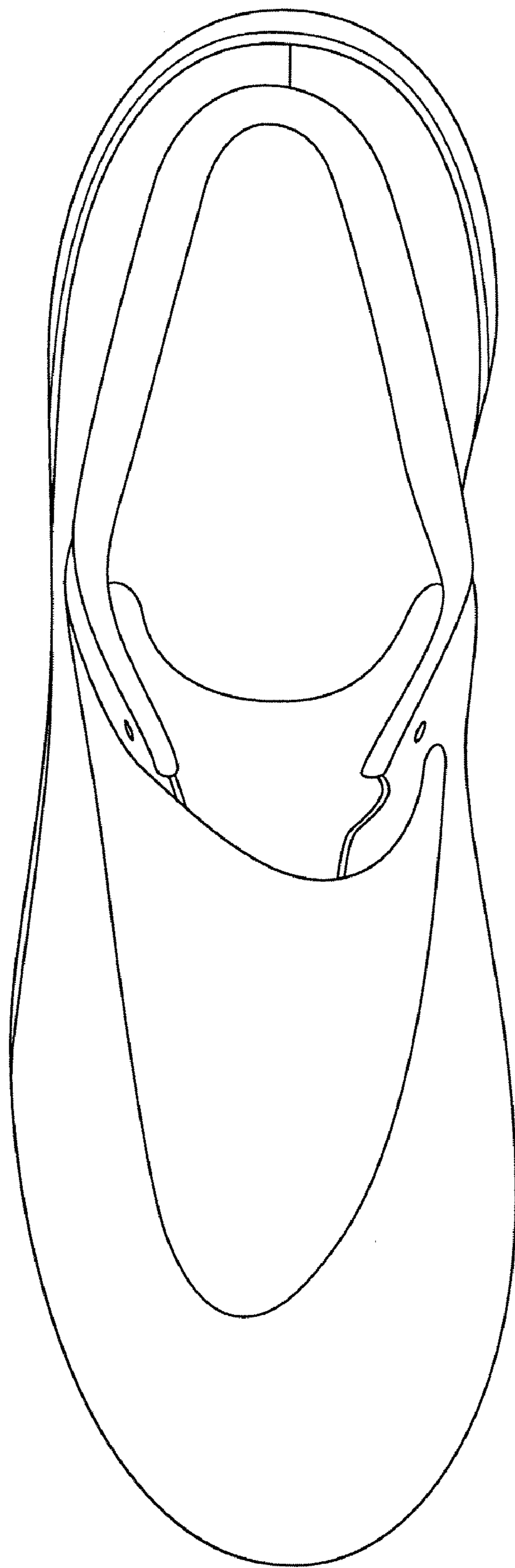

FIG. 6