



US00D575857S

(12) **United States Design Patent**
Chiu

(10) **Patent No.:** **US D575,857 S**
(45) **Date of Patent:** **** Aug. 26, 2008**

(54) **PORTABLE AIR CONDITIONER**

(75) Inventor: **Ming-Tsung Chiu, Chung-Ho (TW)**

(73) Assignee: **New Widetech Industries Co., Ltd.,
Chung-Ho, Taipei Hsien (TW)**

(**) Term: **14 Years**

(21) Appl. No.: **29/294,754**

(22) Filed: **Jan. 25, 2008**

(51) **LOC (8) Cl.** **23-04**

(52) **U.S. Cl.** **D23/333**

(58) **Field of Classification Search** D23/333,
D23/351; 62/262-263, 259.1, 261, 297,
62/324.1, 371, 401, 457.1; 312/31, 401,
312/236, 249.1

See application file for complete search history.

(56) **References Cited**

U.S. PATENT DOCUMENTS

D319,306 S *	8/1991	Yamazaki et al.	D23/351
RE34,867 E *	2/1995	Yamazaki et al.	D23/351
D368,770 S *	4/1996	Tanner et al.	D23/359
D416,993 S *	11/1999	Dong et al.	D23/333
D423,656 S *	4/2000	De'Longhi	D23/333
D448,070 S *	9/2001	De'Longhi	D23/333
D448,836 S *	10/2001	De'Longhi	D23/333

D539,403 S *	3/2007	Pino	D23/351
D549,307 S *	8/2007	Chiu	D23/333
D549,308 S *	8/2007	Chiu	D23/333
D556,309 S *	11/2007	Chiu	D23/333
D558,867 S *	1/2008	Chun et al.	D23/351

* cited by examiner

Primary Examiner—Brian N Vinson

(74) *Attorney, Agent, or Firm*—Charles E. Baxley

(57) **CLAIM**

The ornamental design for a portable air conditioner, as shown.

DESCRIPTION

FIG. 1 is a perspective view of a portable air conditioner showing my new design;

FIG. 2 is a rear perspective view thereof;

FIG. 3 is a front view thereof;

FIG. 4 is a rear view thereof;

FIG. 5 is a left view thereof;

FIG. 6 is a right view thereof;

FIG. 7 is a top view thereof; and,

FIG. 8 is a bottom view thereof.

1 Claim, 8 Drawing Sheets

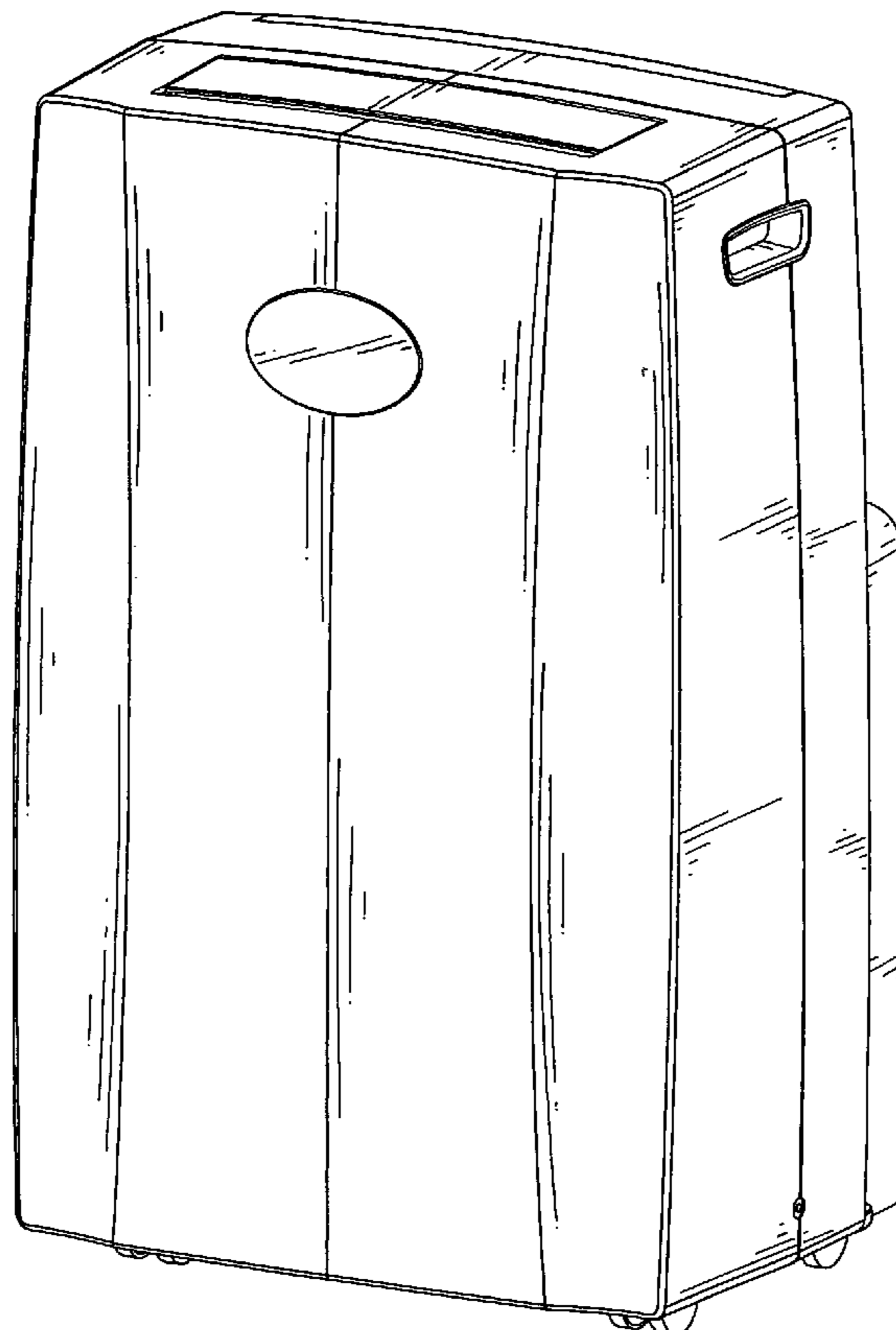

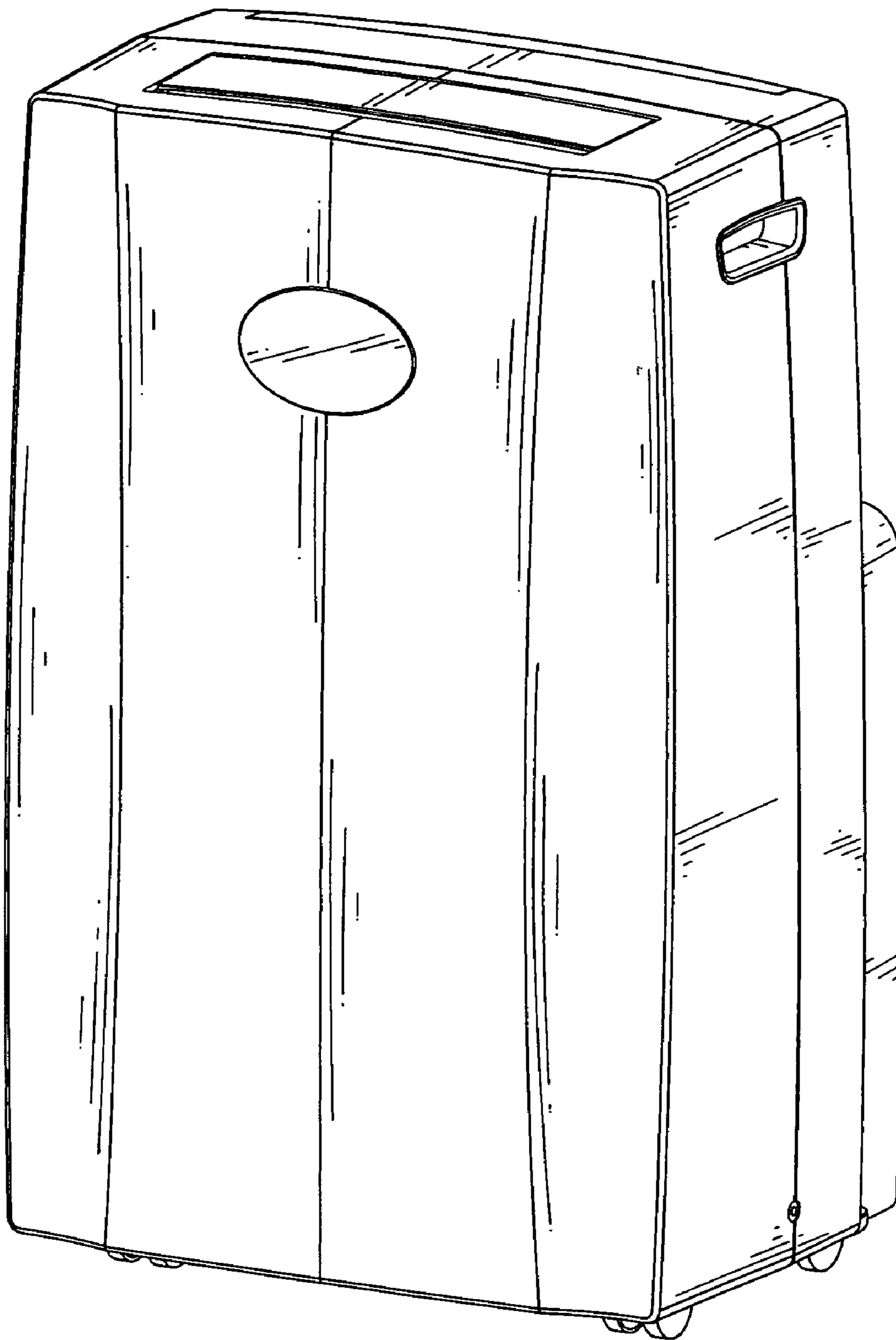

FIG. 1

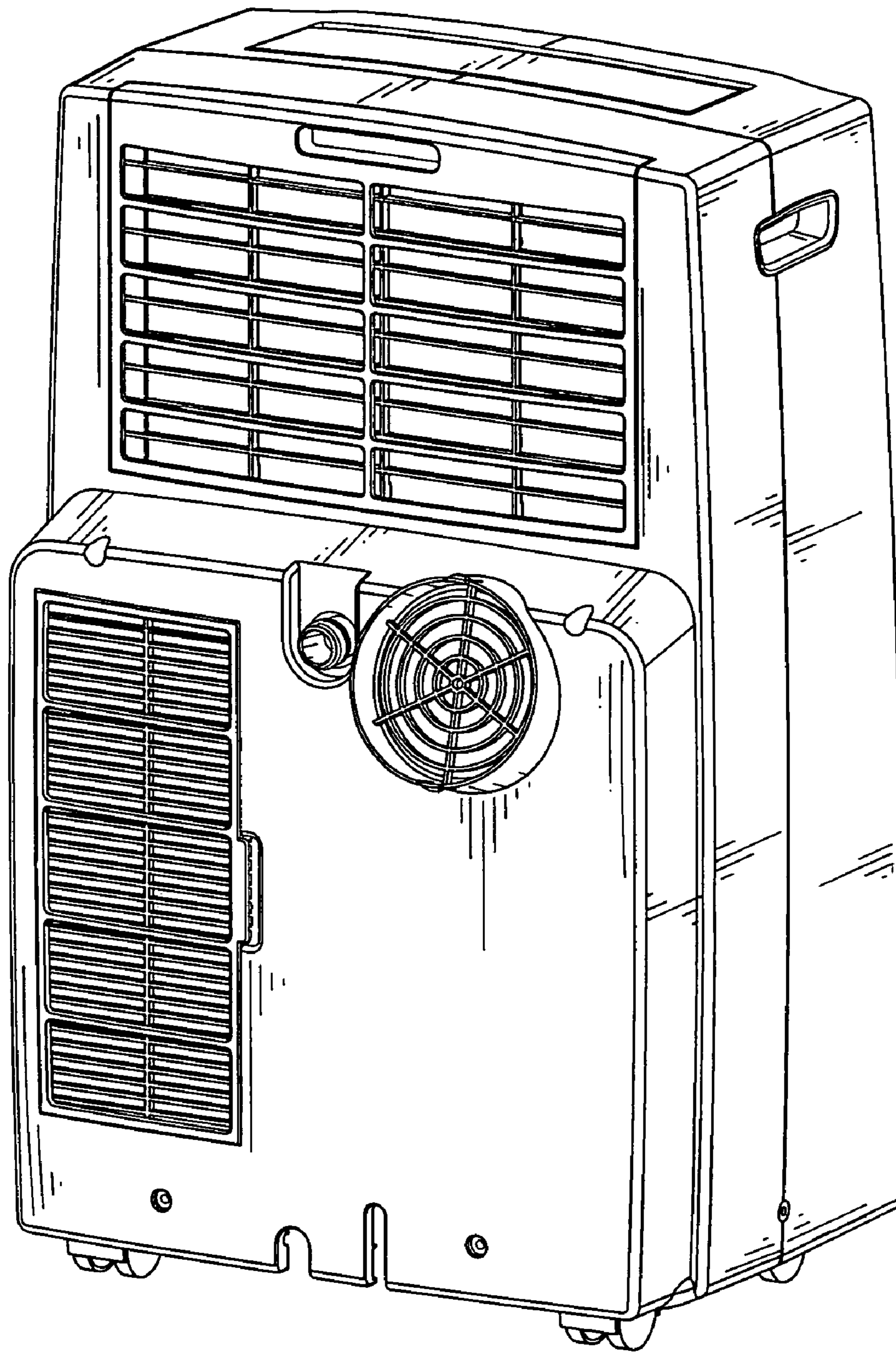

FIG. 2

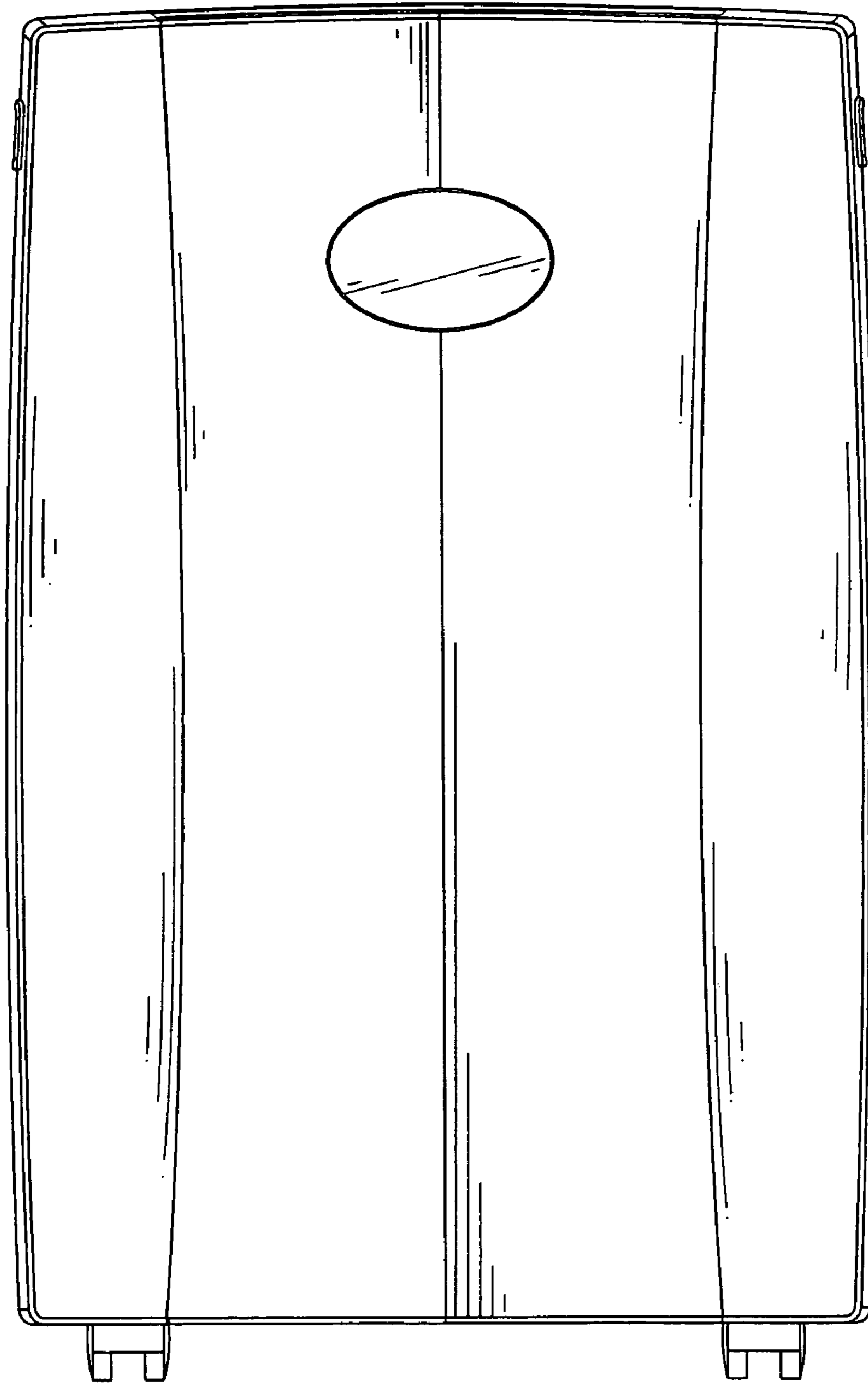

FIG. 3

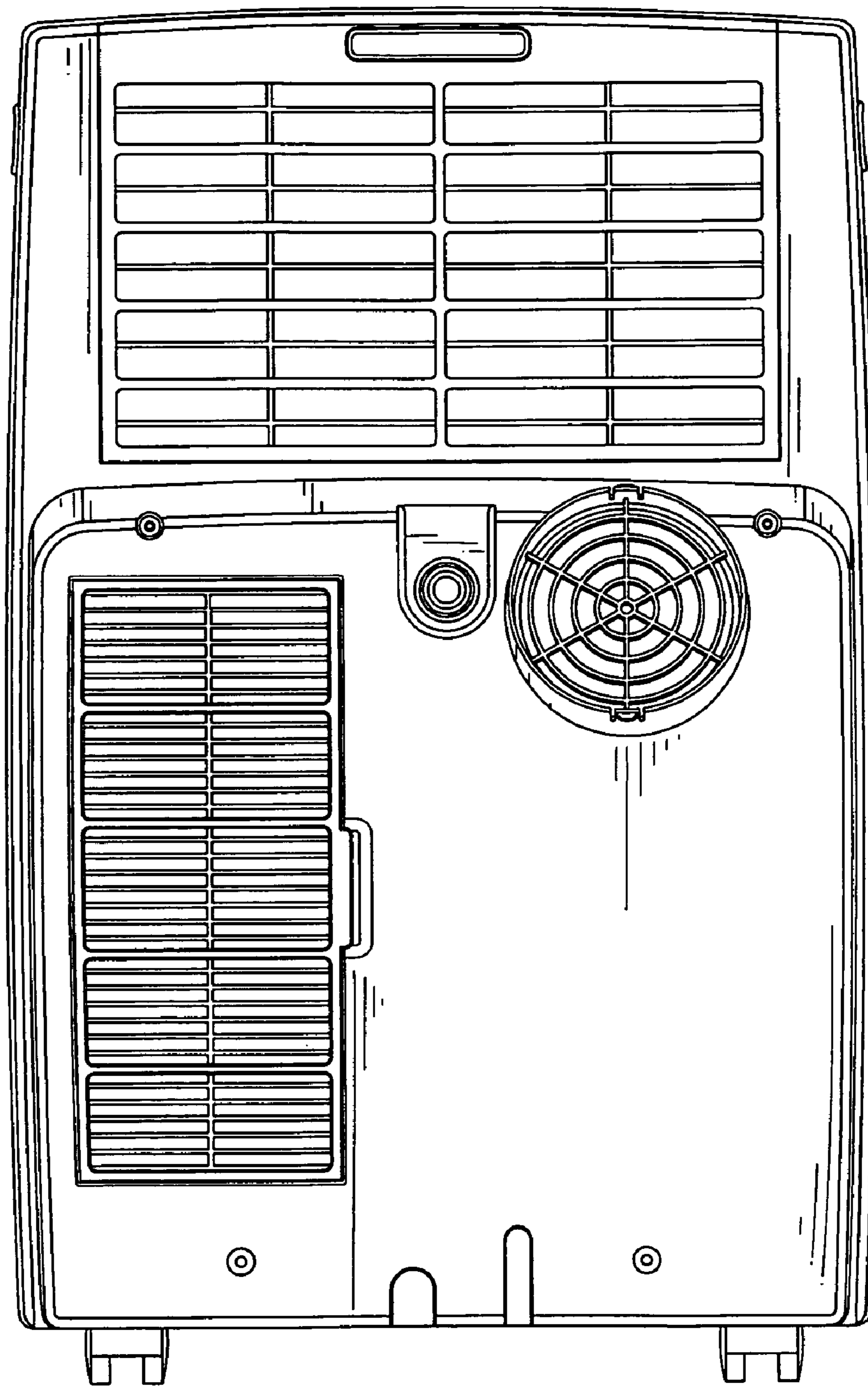

FIG. 4

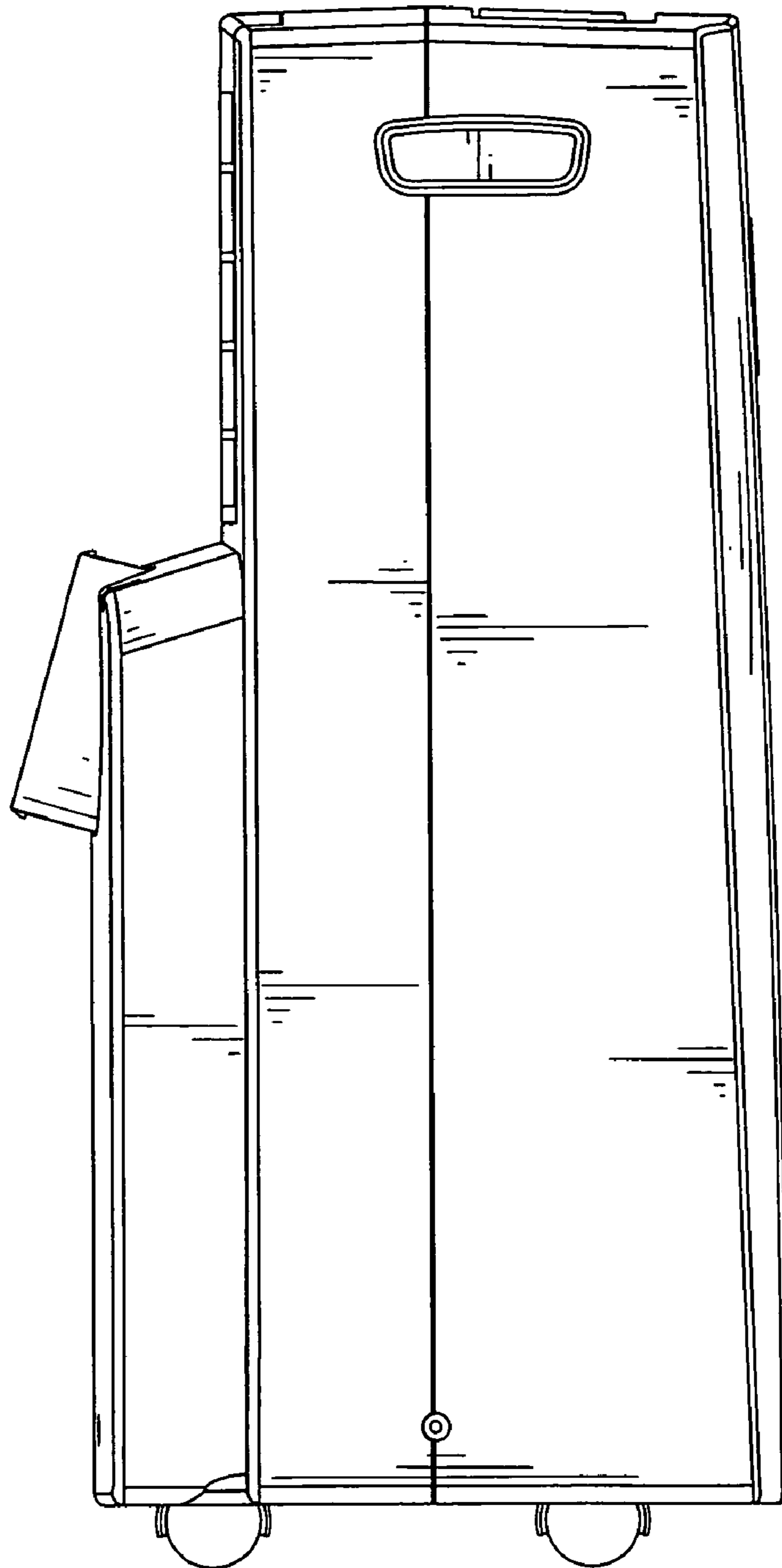

FIG. 5

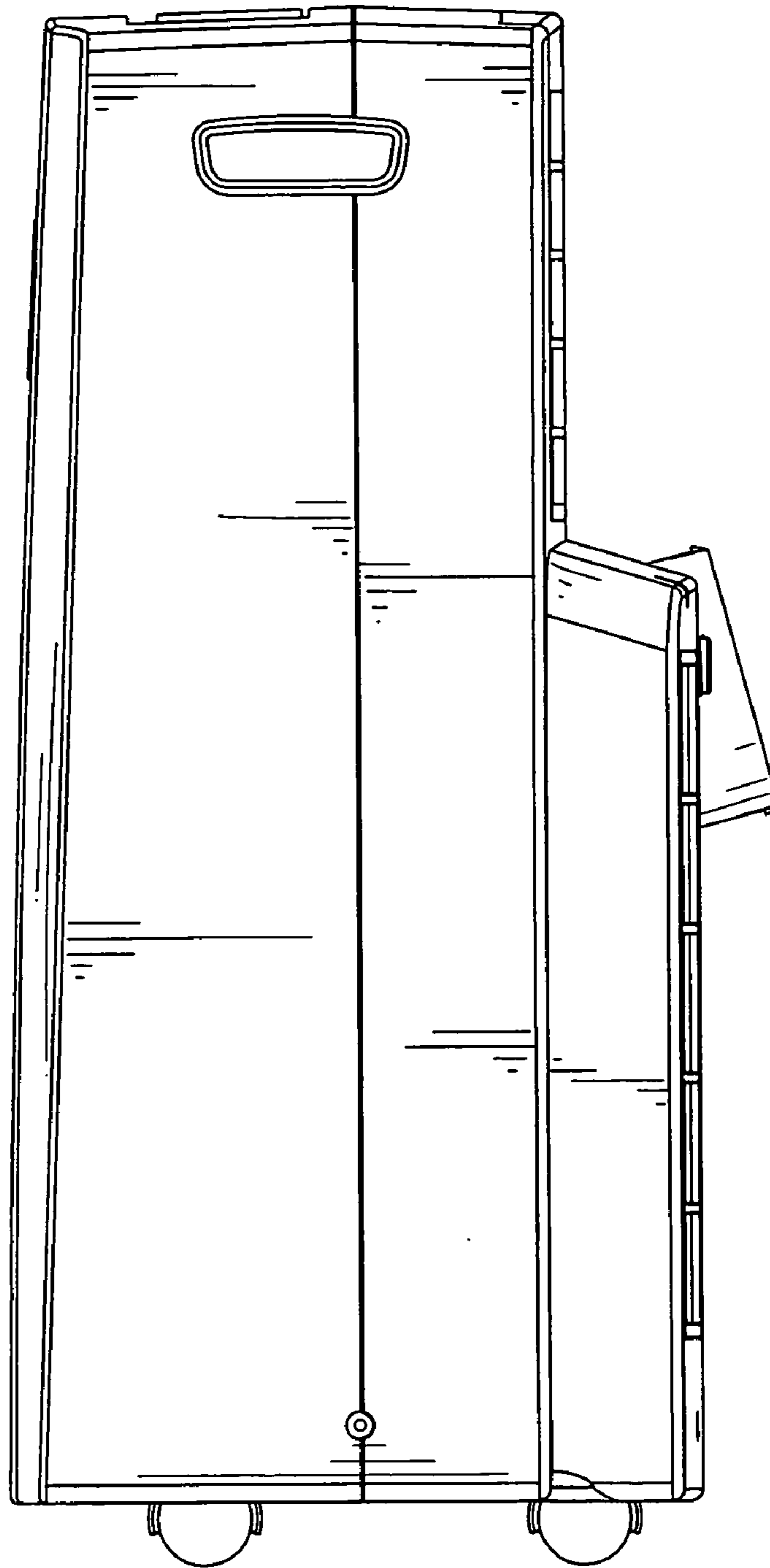

FIG. 6

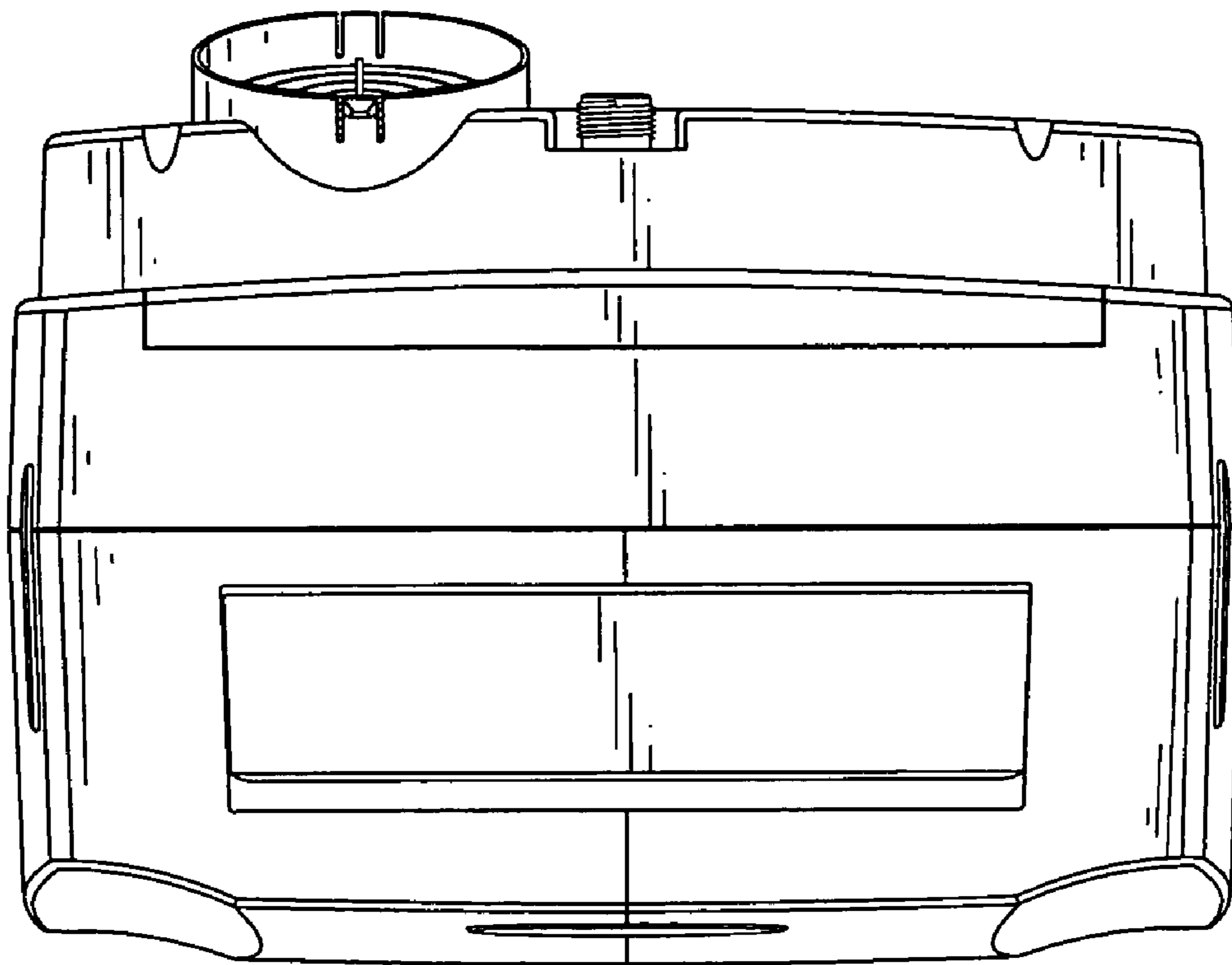

FIG. 7

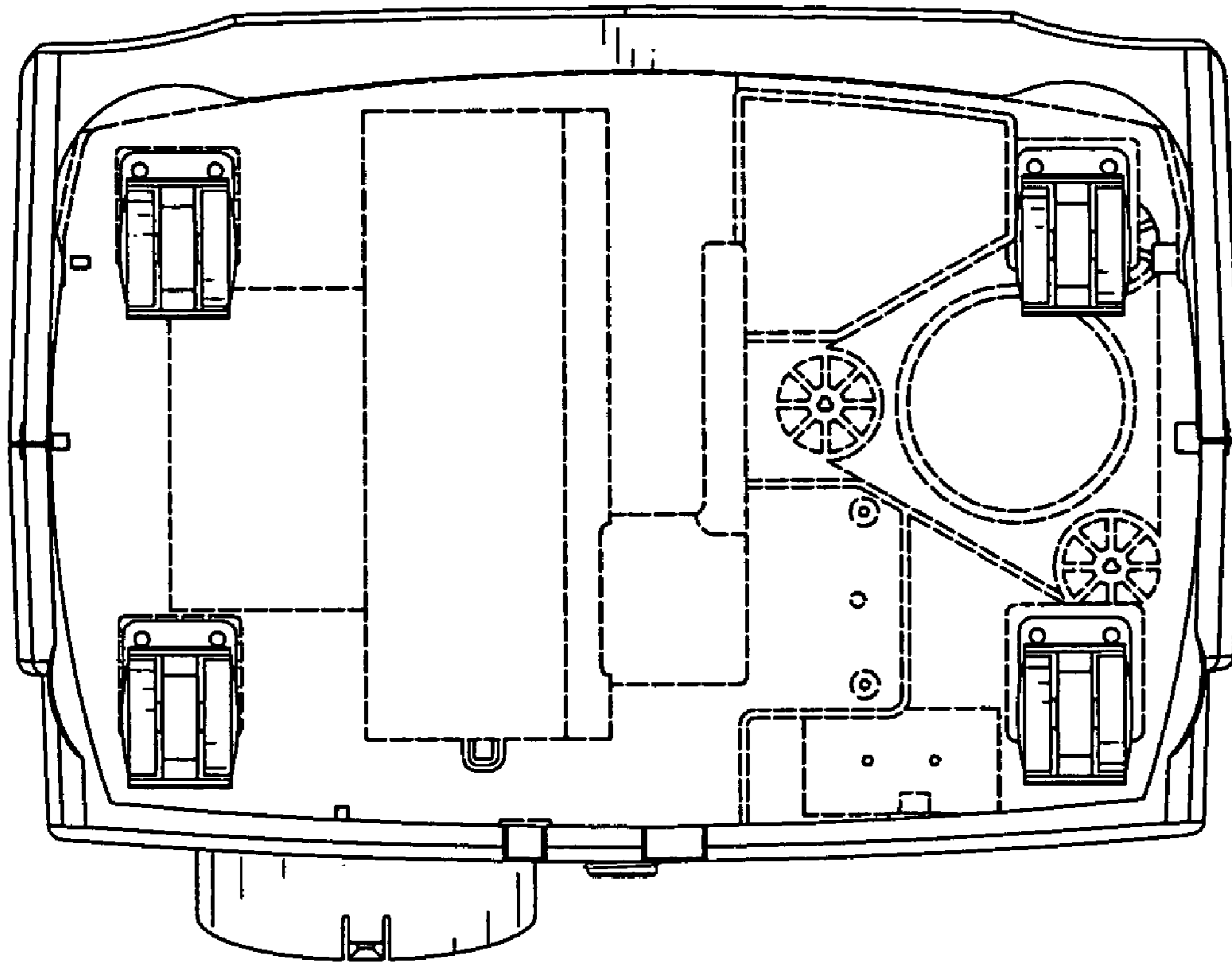

FIG. 8