

US00D575809S

(12) **United States Design Patent**
Hebiishi

(10) **Patent No.:** **US D575,809 S**
(45) **Date of Patent:** **** Aug. 26, 2008**

(54) **IMAGE PICKUP MICROSCOPE**

(75) Inventor: **Hiroyasu Hebiishi**, Hachioji (JP)

(73) Assignee: **Olympus Corporation**, Tokyo (JP)

(**) Term: **14 Years**

(21) Appl. No.: **29/278,892**

(22) Filed: **Apr. 12, 2007**

(30) **Foreign Application Priority Data**

Oct. 16, 2006	(JP)	2006-028006
Oct. 16, 2006	(JP)	2006-028007
Oct. 16, 2006	(JP)	2006-028008
Oct. 16, 2006	(JP)	2006-028009
Oct. 16, 2006	(JP)	2006-028010
Oct. 16, 2006	(JP)	2006-028011

(51) **LOC (8) Cl.** **16-06**

(52) **U.S. Cl.** **D16/131**

(58) **Field of Classification Search** D16/131;
359/363, 368, 369, 382; D3/294, 903; D21/483
See application file for complete search history.

(56) **References Cited**

U.S. PATENT DOCUMENTS

4,210,384	A *	7/1980	Meyer et al.	359/363
4,676,608	A *	6/1987	Faubion	359/383
D332,616	S *	1/1993	Hashimoto et al.	D16/131
D340,252	S *	10/1993	Frenkler et al.	D16/131
D354,761	S *	1/1995	Komatsuzaki et al.	D16/131
D359,059	S *	6/1995	Omi	D16/131
D369,611	S *	5/1996	Hasegawa	D16/131
5,694,242	A *	12/1997	Omi	359/369
5,969,852	A *	10/1999	Kung	359/369
D528,794	S *	9/2006	Lanham et al.	D3/294

* cited by examiner

Primary Examiner—Paula A Greene

(74) *Attorney, Agent, or Firm*—Hogan & Hartson LLP

(57) **CLAIM**

The ornamental design for an image pickup microscope, as shown and described.

DESCRIPTION

FIG. 1 is a front elevational view of an image pickup microscope, showing my new design;

FIG. 2 is a rear elevational view thereof;

FIG. 3 is a top plan view thereof;

FIG. 4 is a bottom plan view thereof;

FIG. 5 is a left side elevational view thereof;

FIG. 6 is a right side elevational view thereof;

FIG. 7 is a perspective view thereof with a cover in an opened state, the undisclosed portions are not part of the claimed design;

FIG. 8 is a front elevational view of a second embodiment of an image pickup microscope showing my new design;

FIG. 9 is a rear elevational view thereof;

FIG. 10 is a top plan view thereof;

FIG. 11 is a bottom plan view thereof;

FIG. 12 is a left side elevational view thereof;

FIG. 13 is a right side elevational view thereof;

FIG. 14 is a front elevational view of a third embodiment of an image pickup microscope showing my new design;

FIG. 15 is a rear elevational view thereof;

FIG. 16 is a top plan view thereof;

FIG. 17 is a bottom plan view thereof;

FIG. 18 is a left side elevational view thereof;

FIG. 19 is a right side elevational view thereof;

FIG. 20 is a front elevational view of a fourth embodiment of an image pickup microscope showing my new design;

FIG. 21 is a rear elevational view thereof;

FIG. 22 is a top plan view thereof;

FIG. 23 is a bottom plan view thereof;

FIG. 24 is a left side elevational view thereof; and,

FIG. 25 is a right side elevational view thereof.

1 Claim, 5 Drawing Sheets

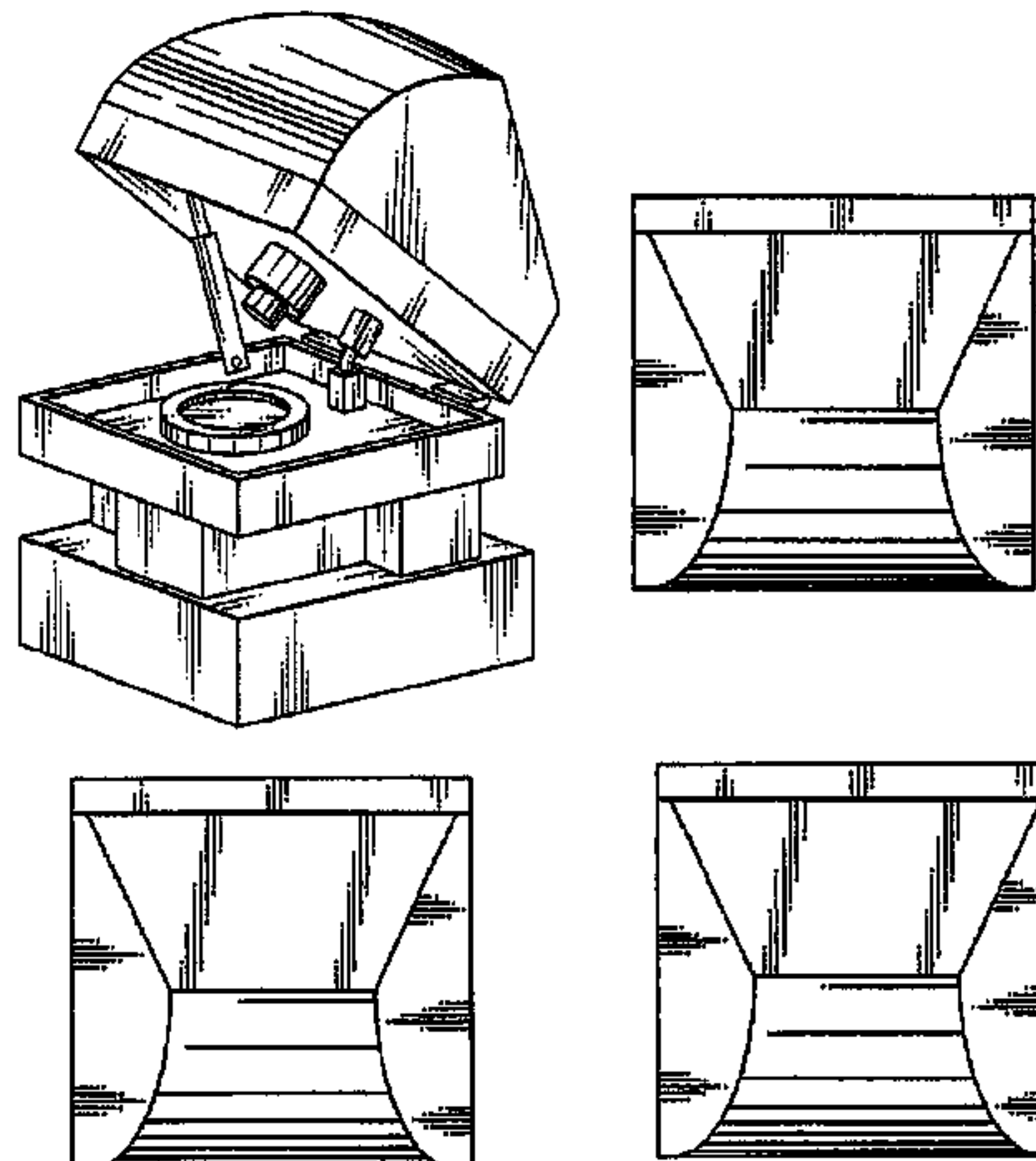

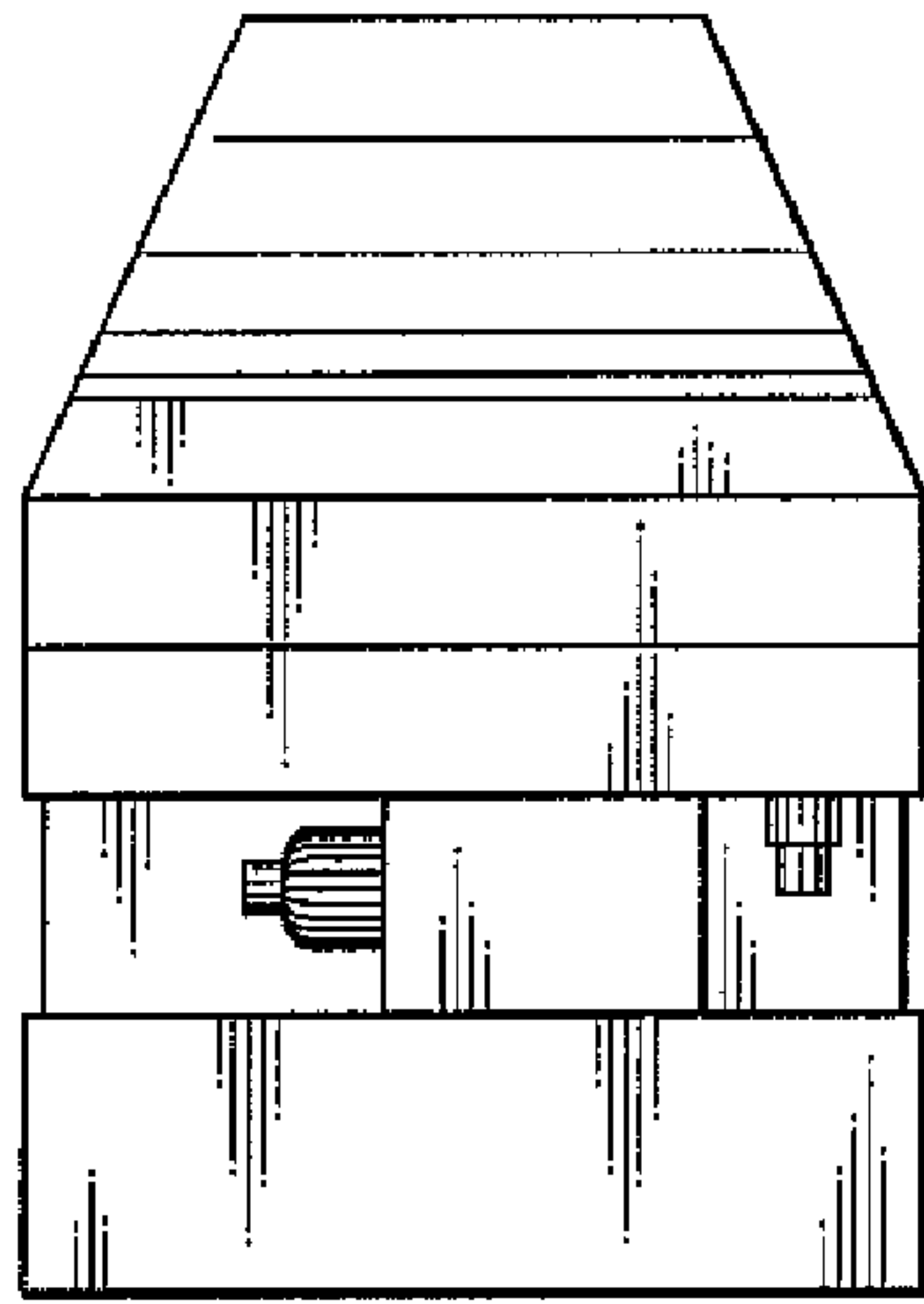

FIG. 1

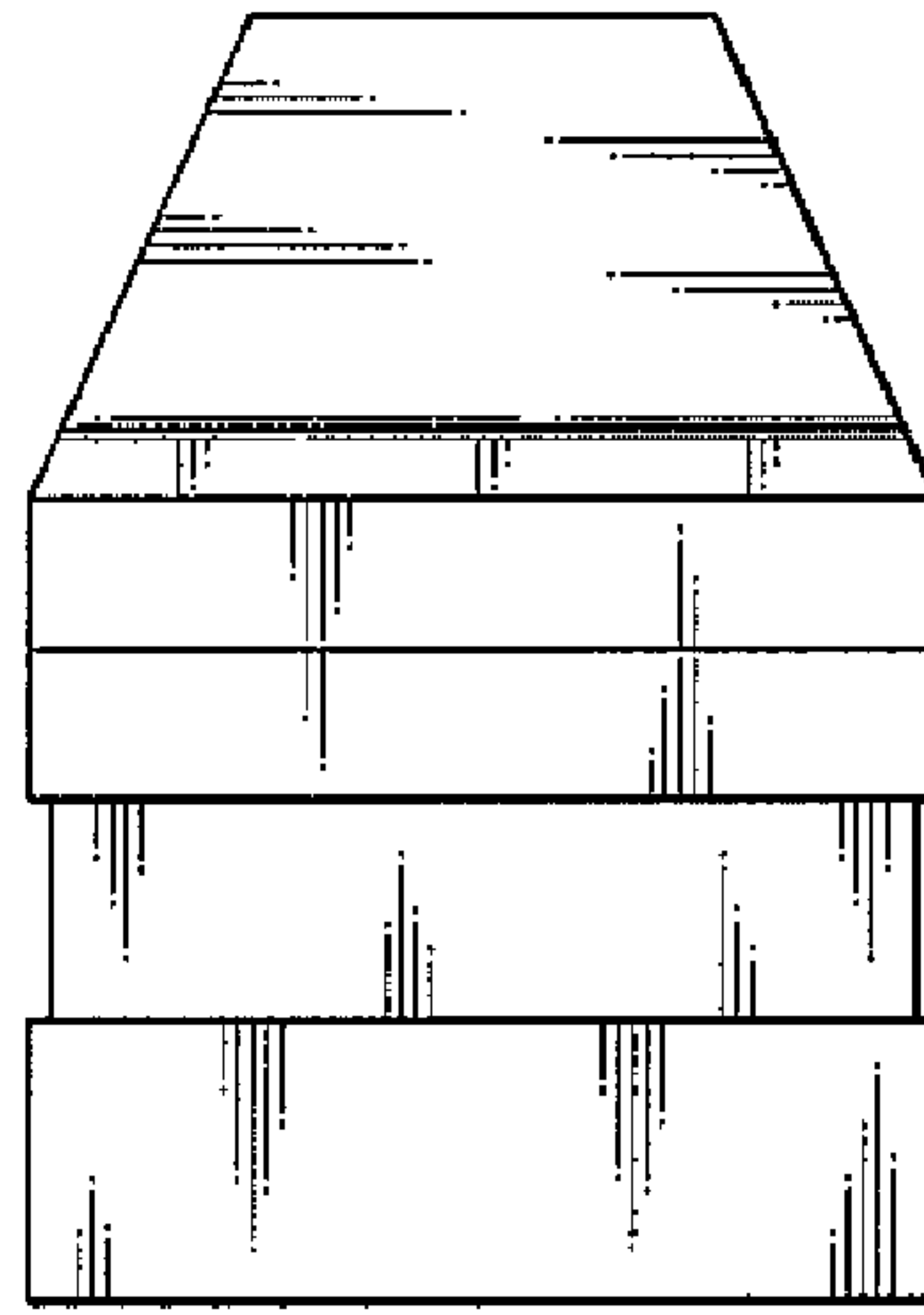

FIG. 2

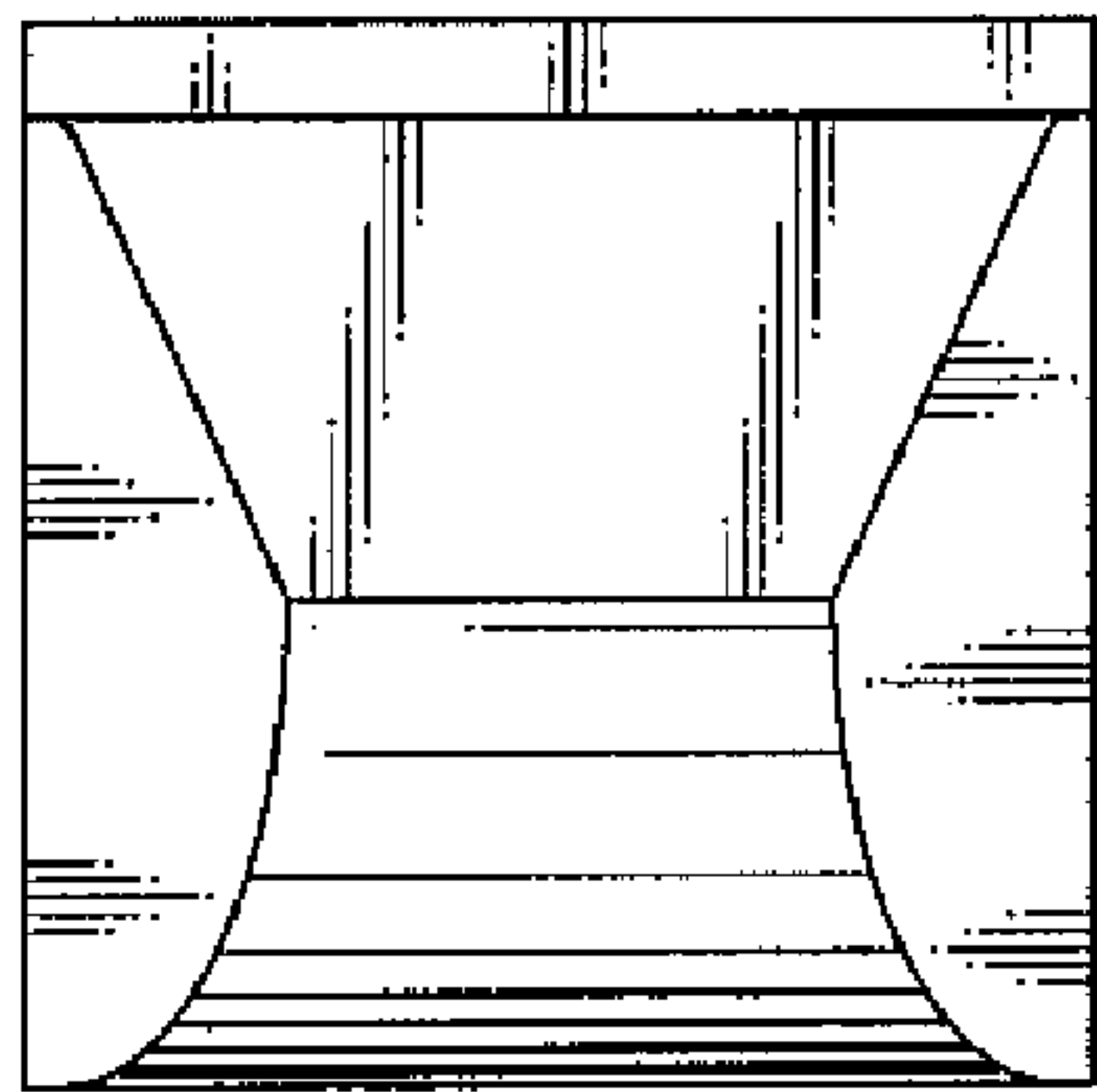

FIG. 3

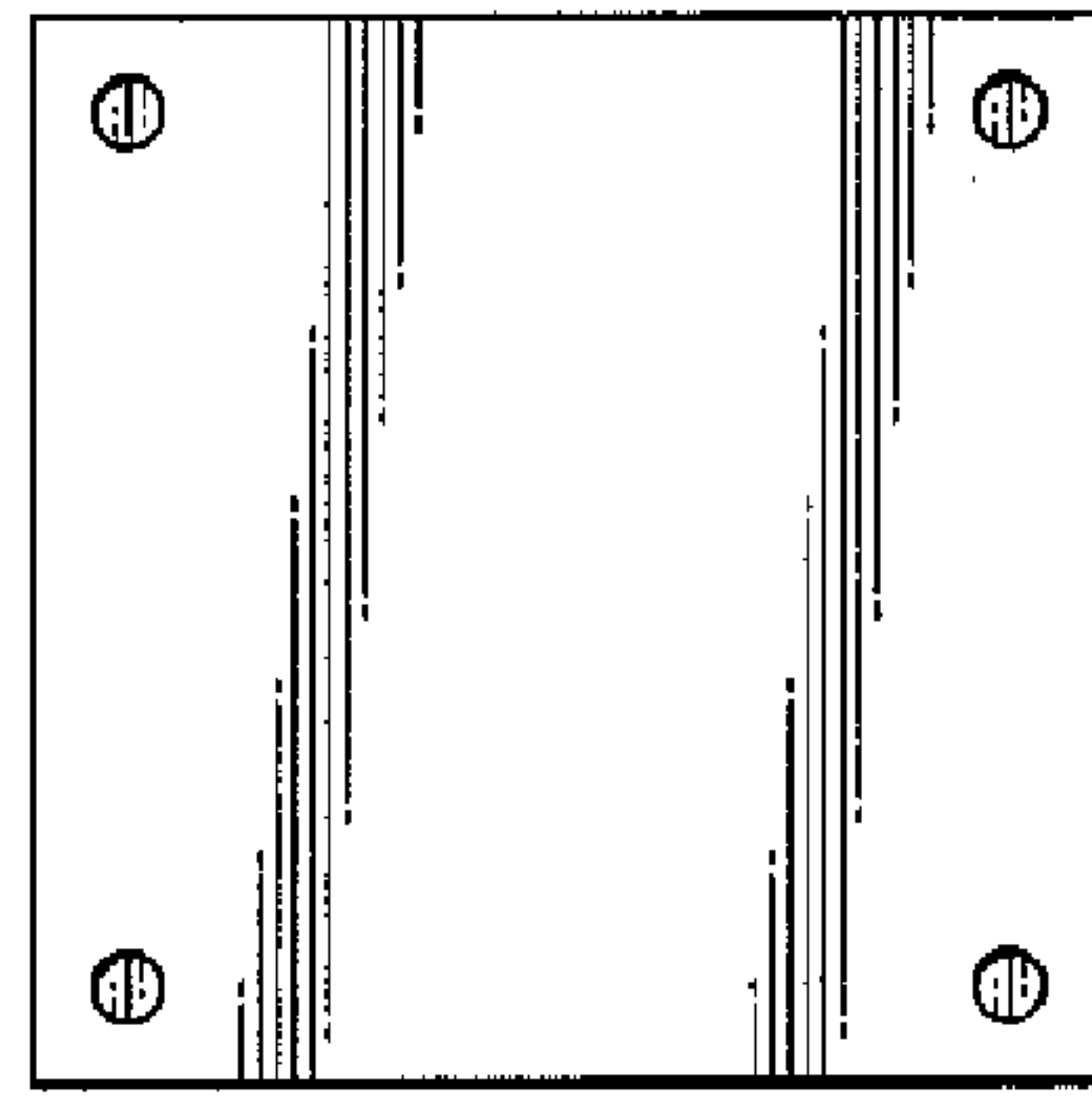

FIG. 4

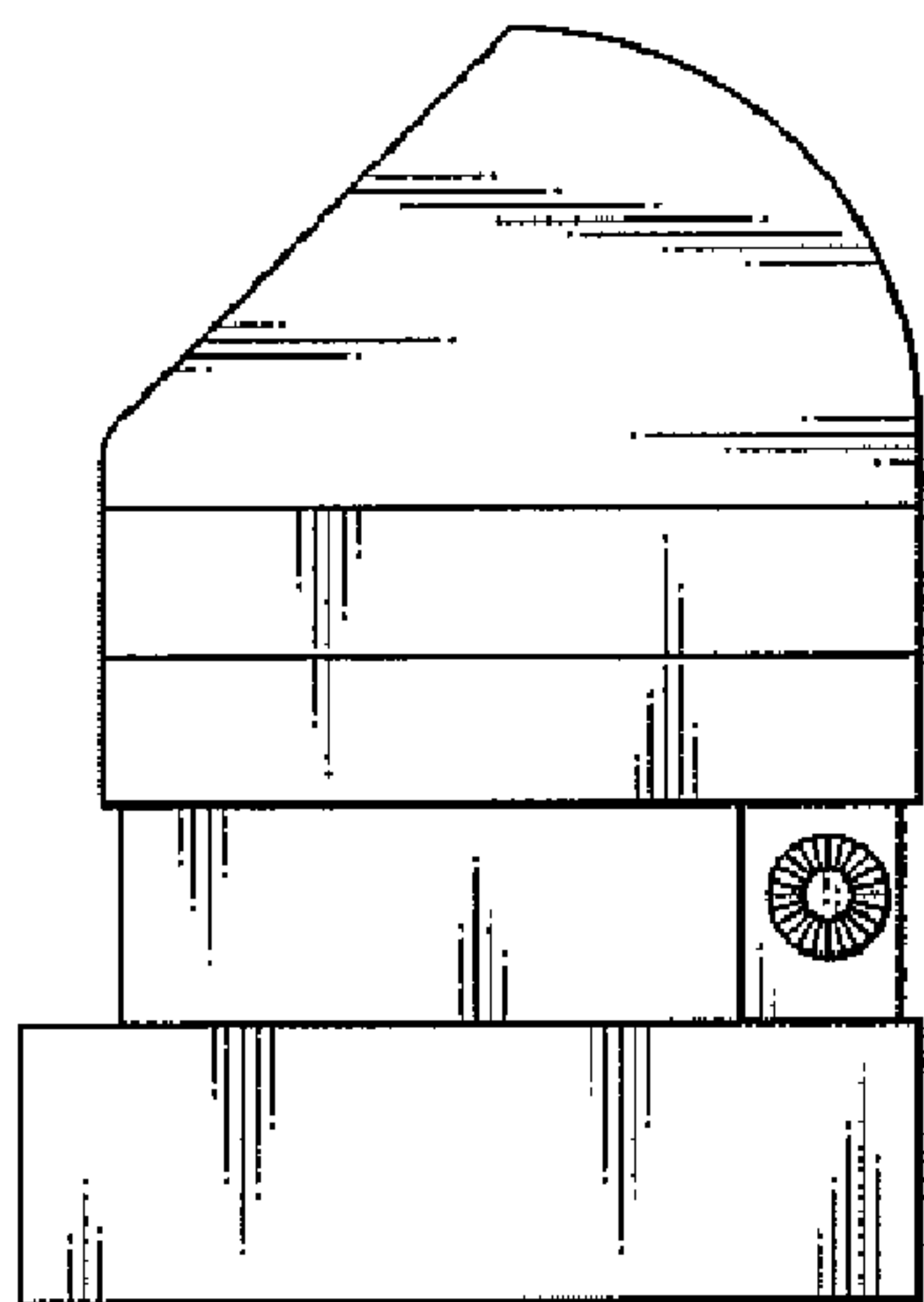

FIG. 5

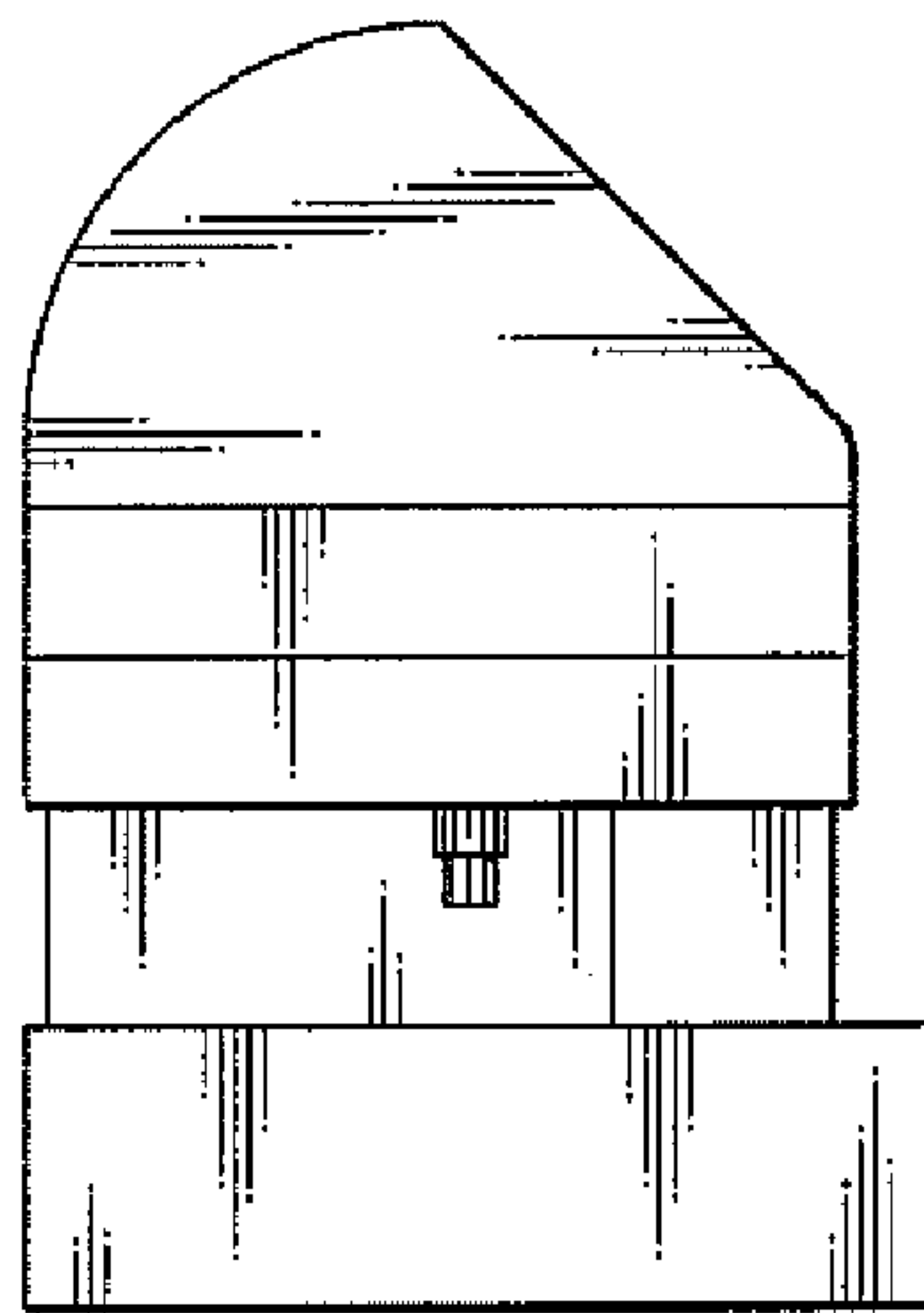

FIG. 6

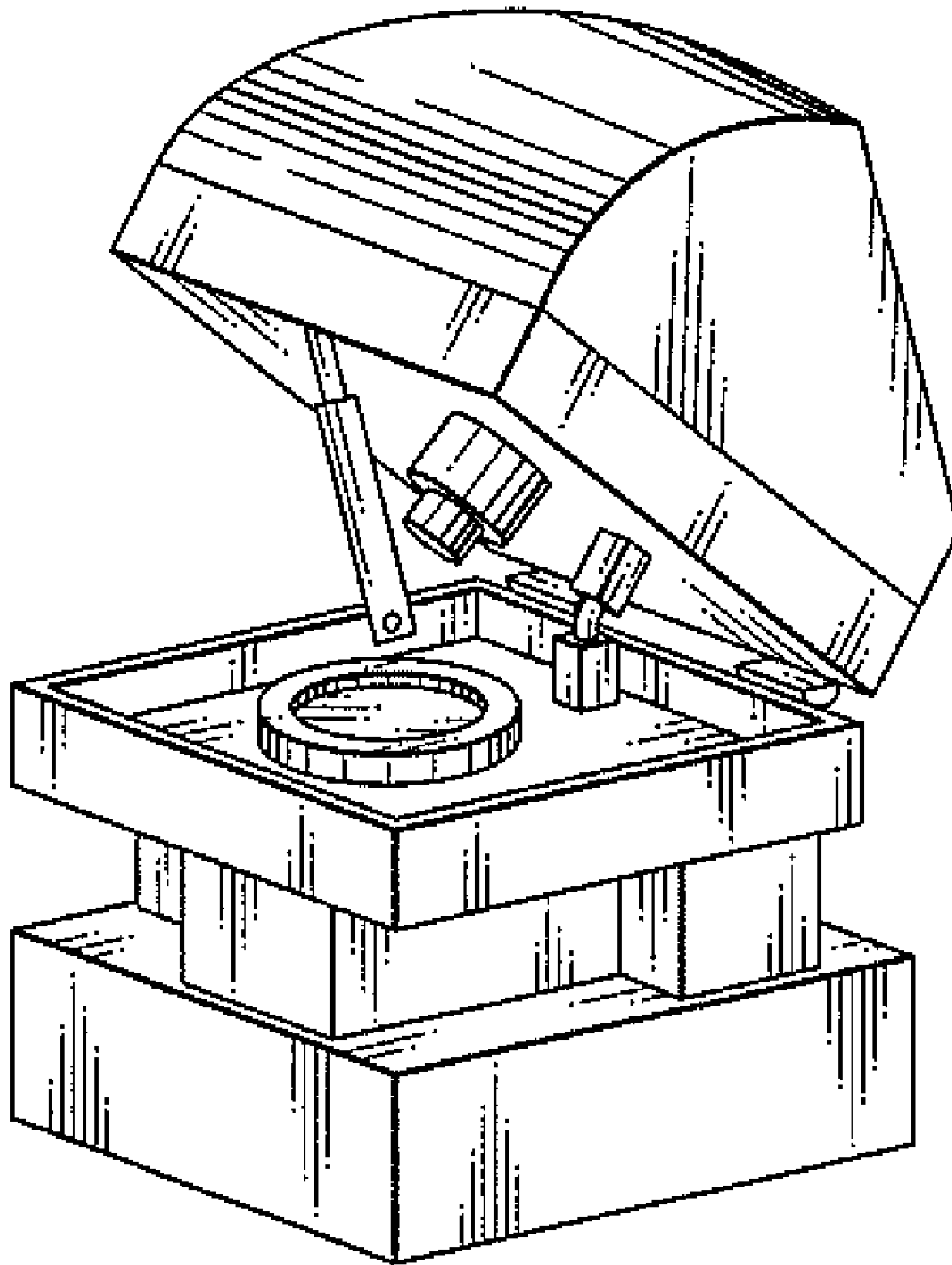

FIG. 7

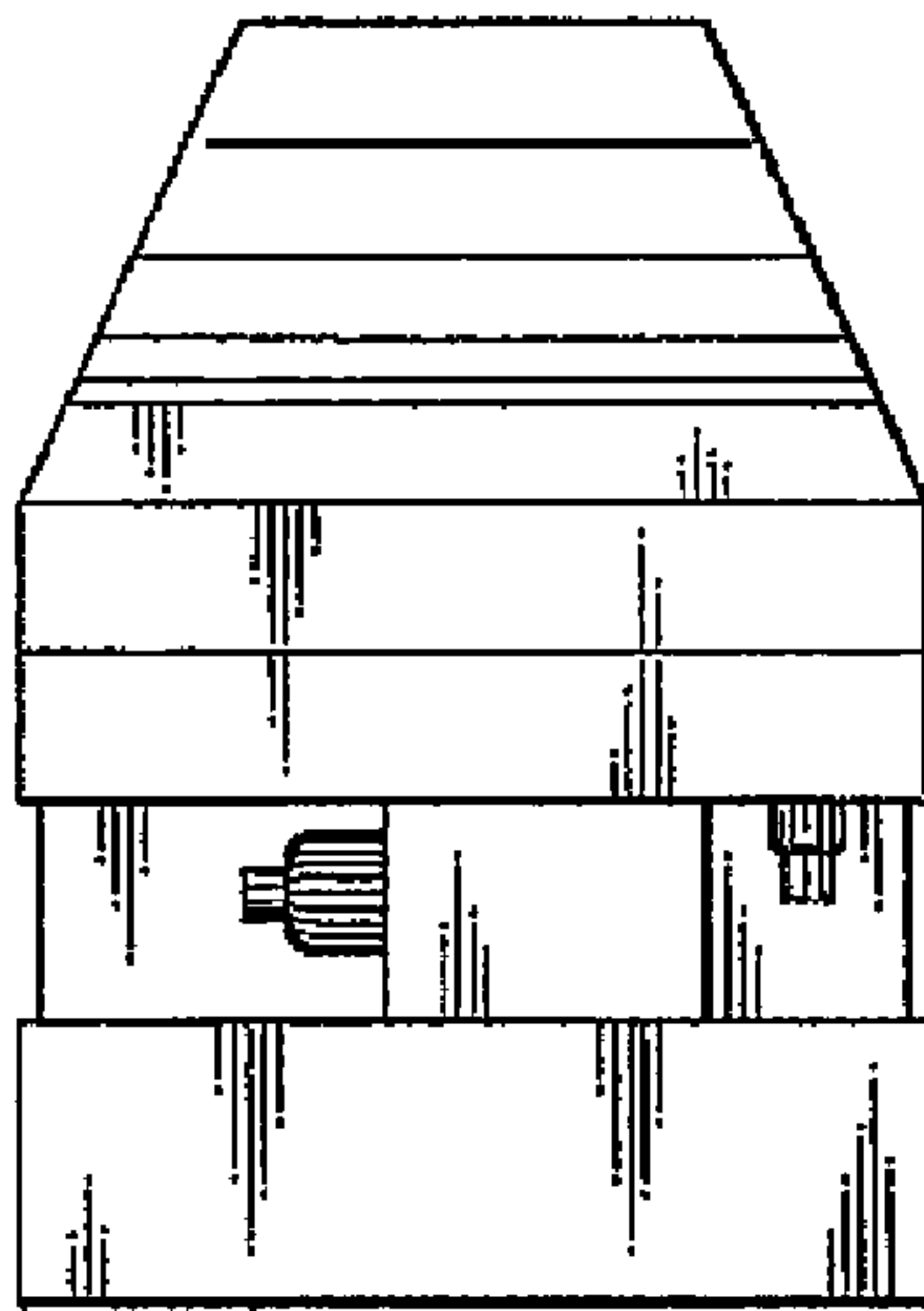

FIG. 8

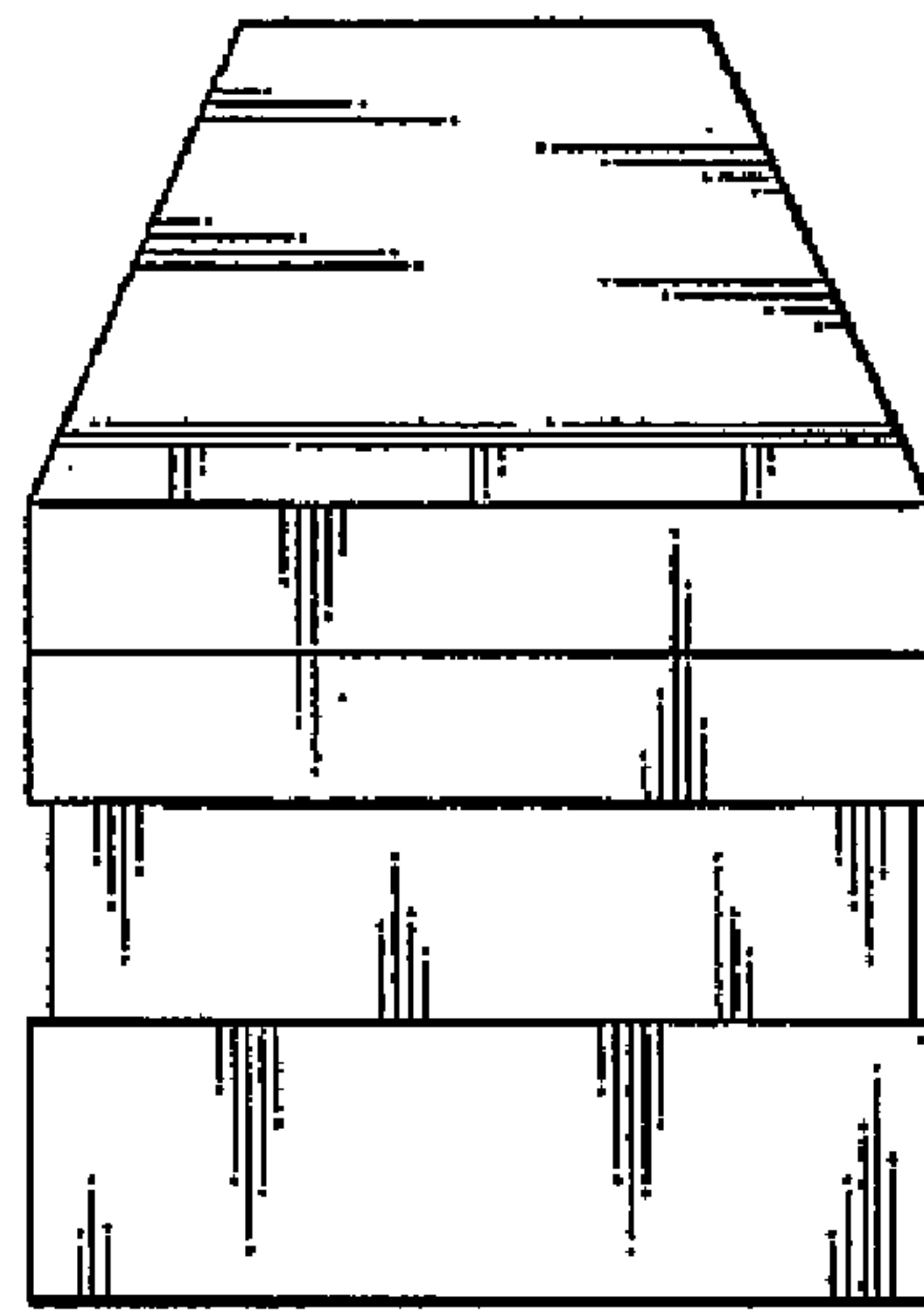

FIG. 9

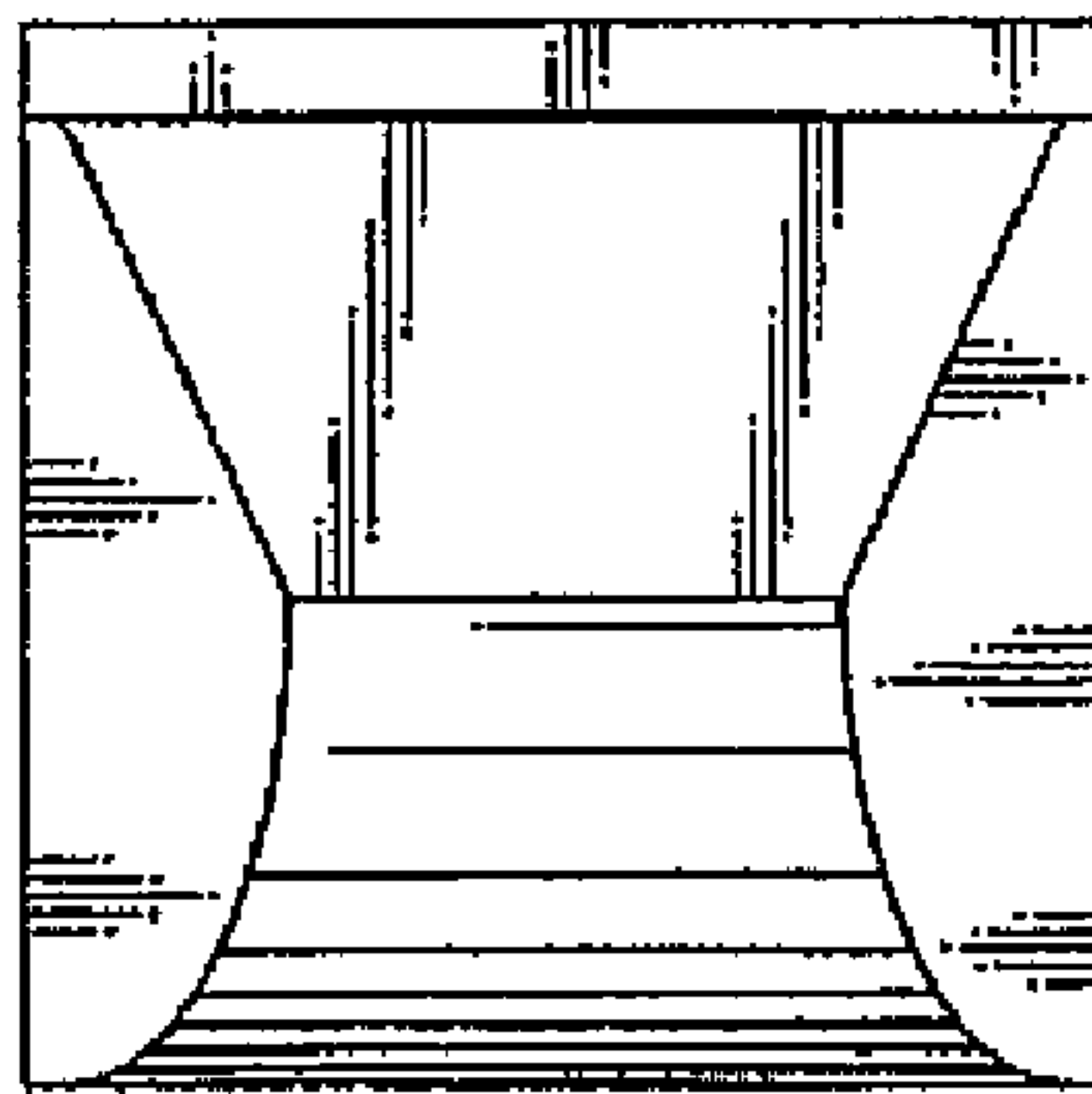

FIG. 10

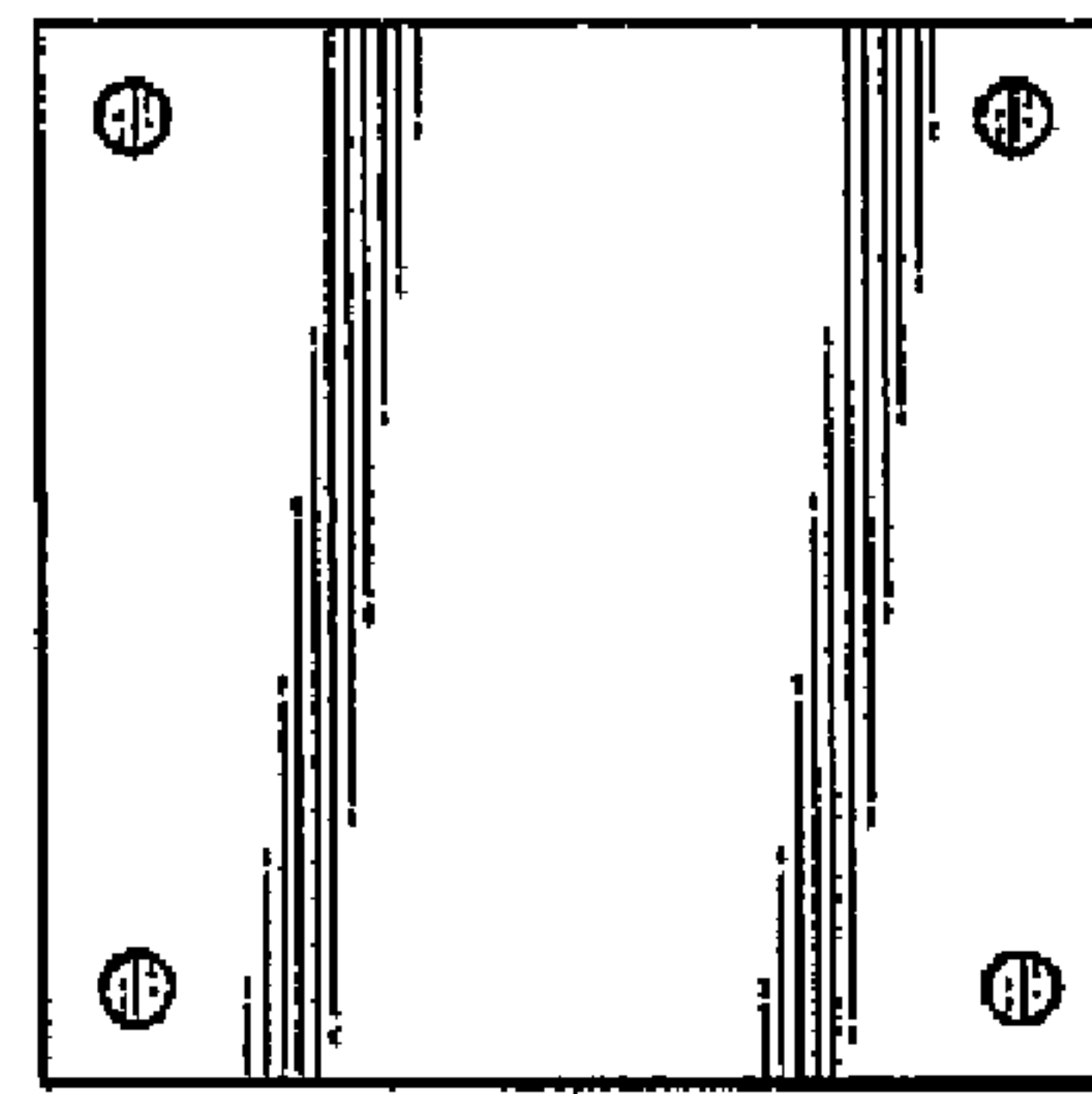

FIG. 11

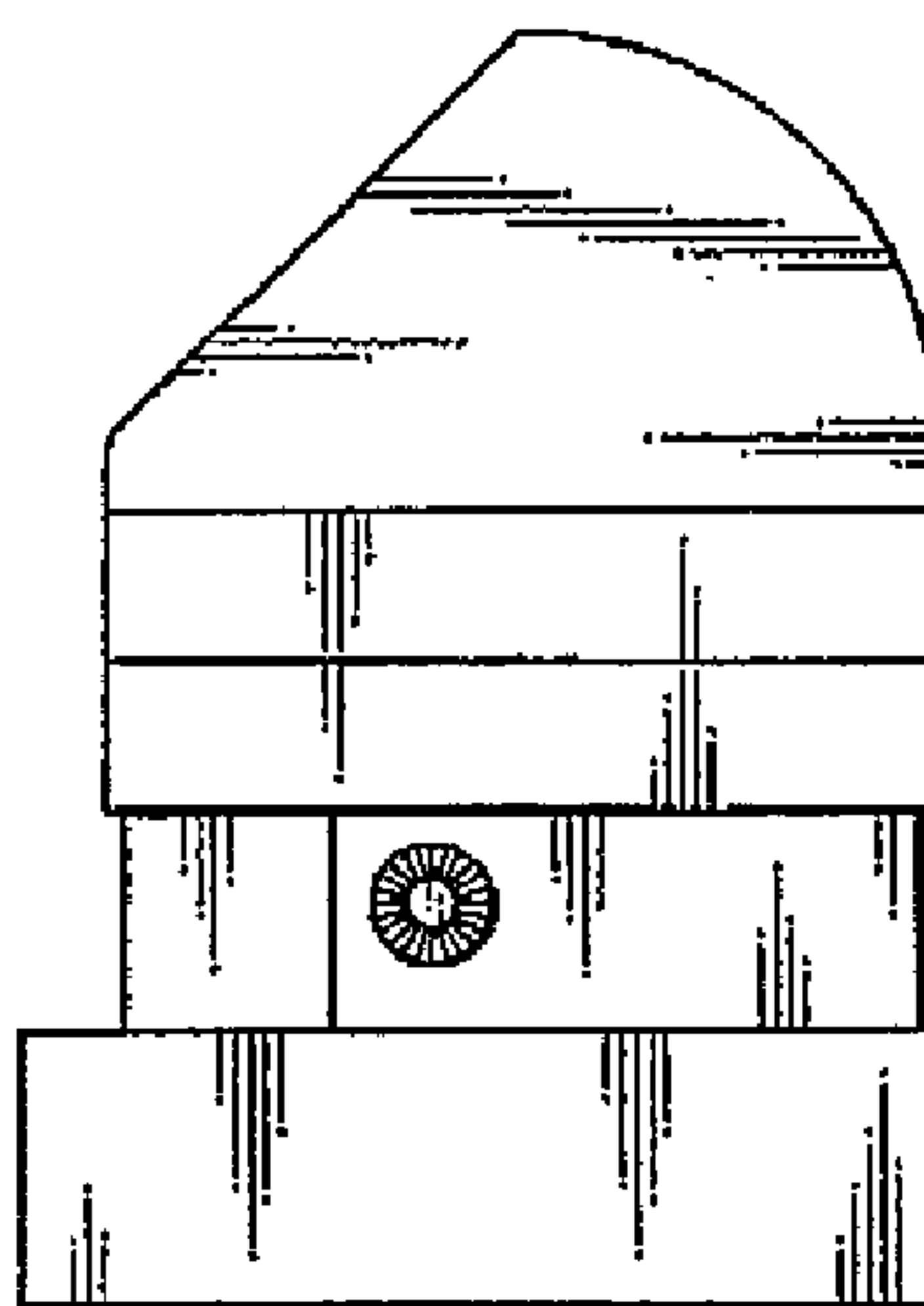

FIG. 12

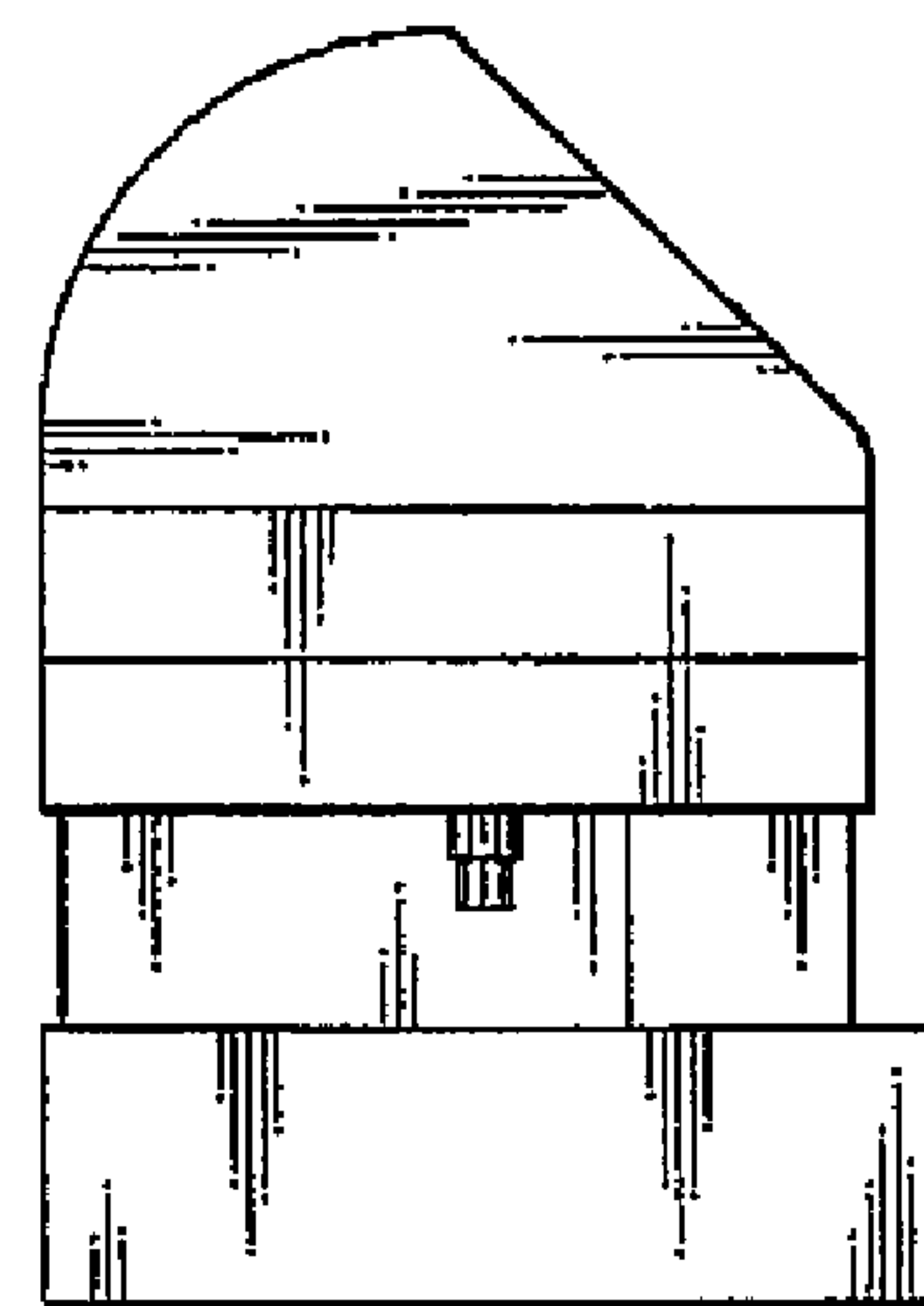

FIG. 13

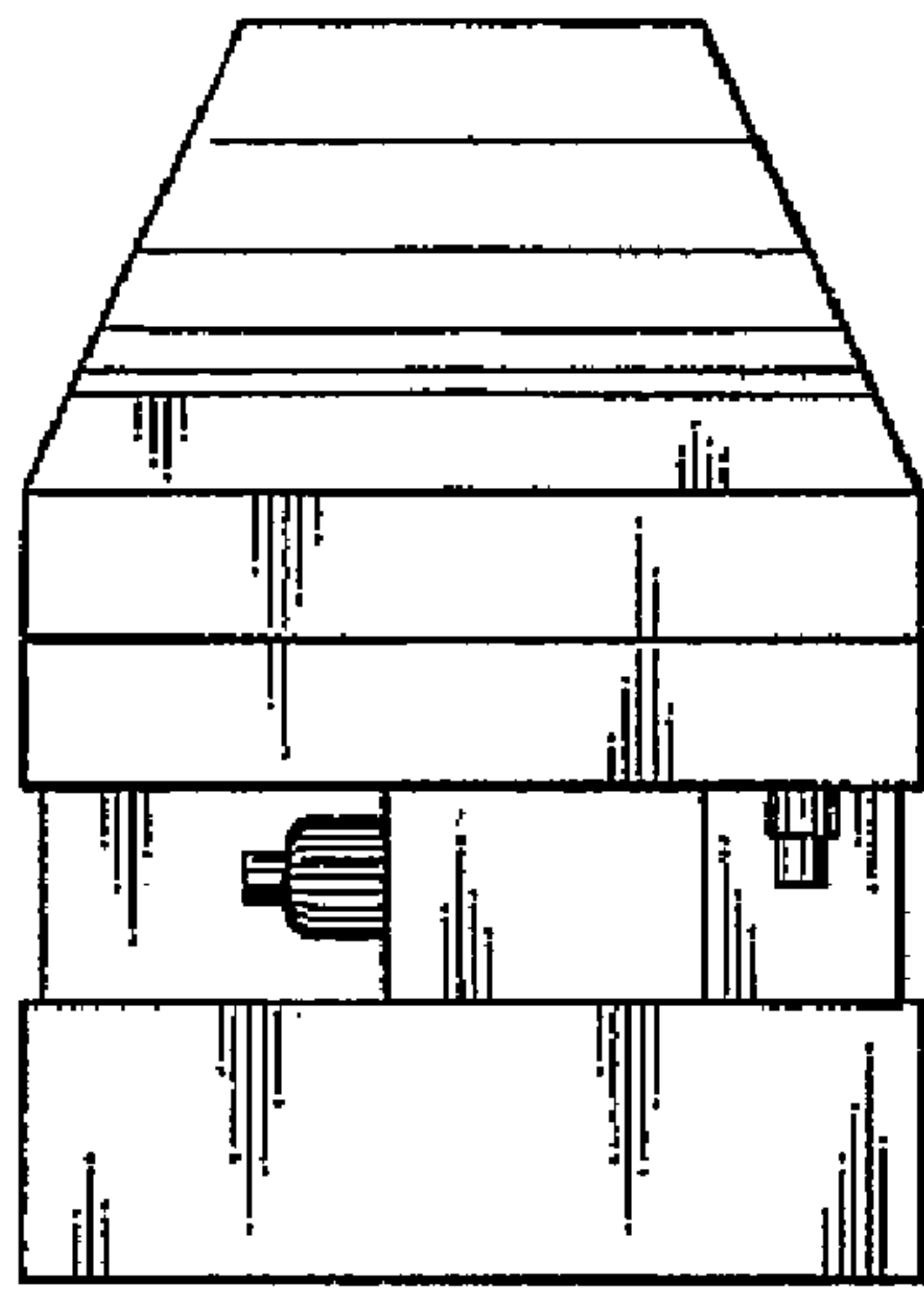

FIG. 14

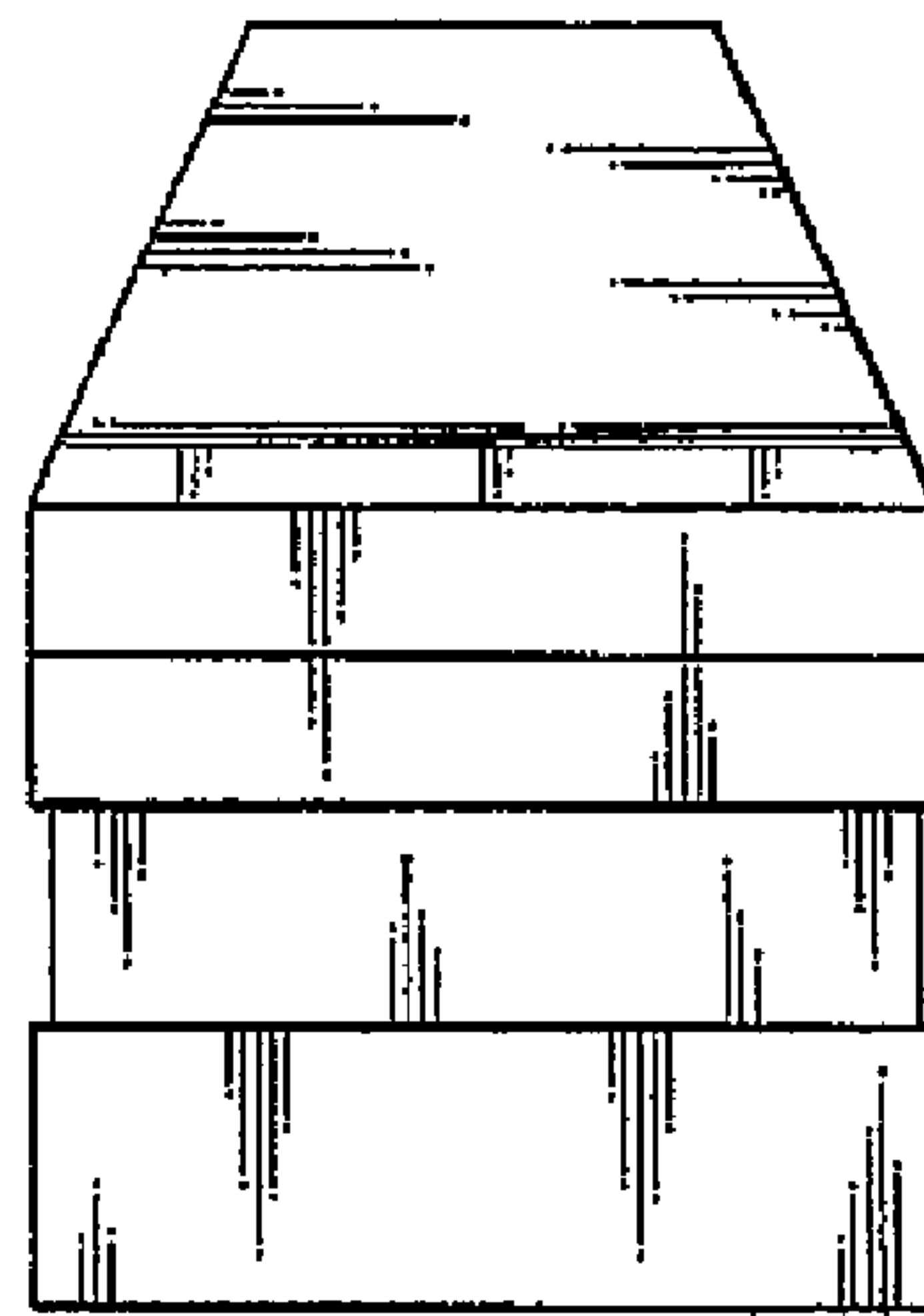

FIG. 15

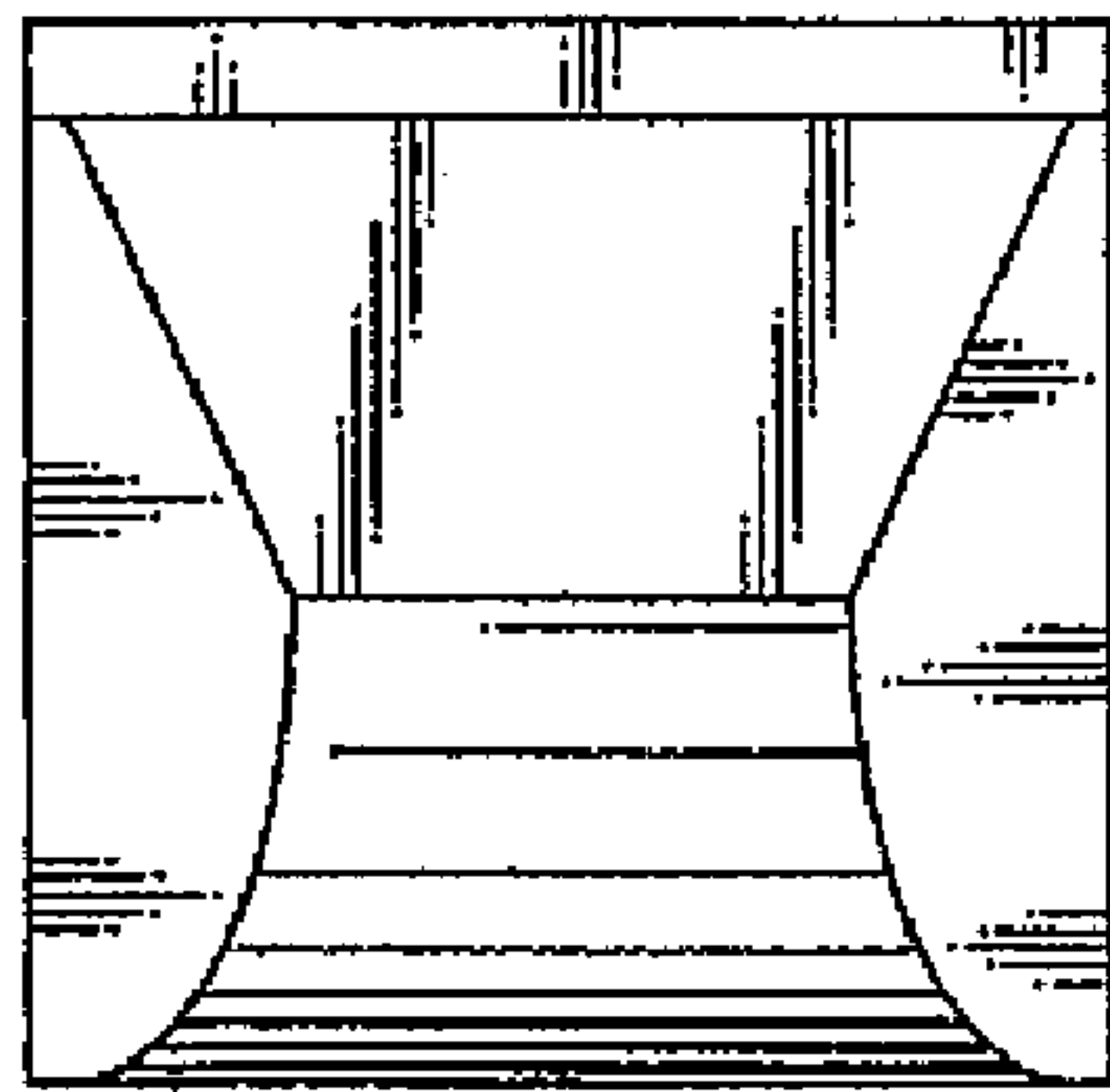

FIG. 16

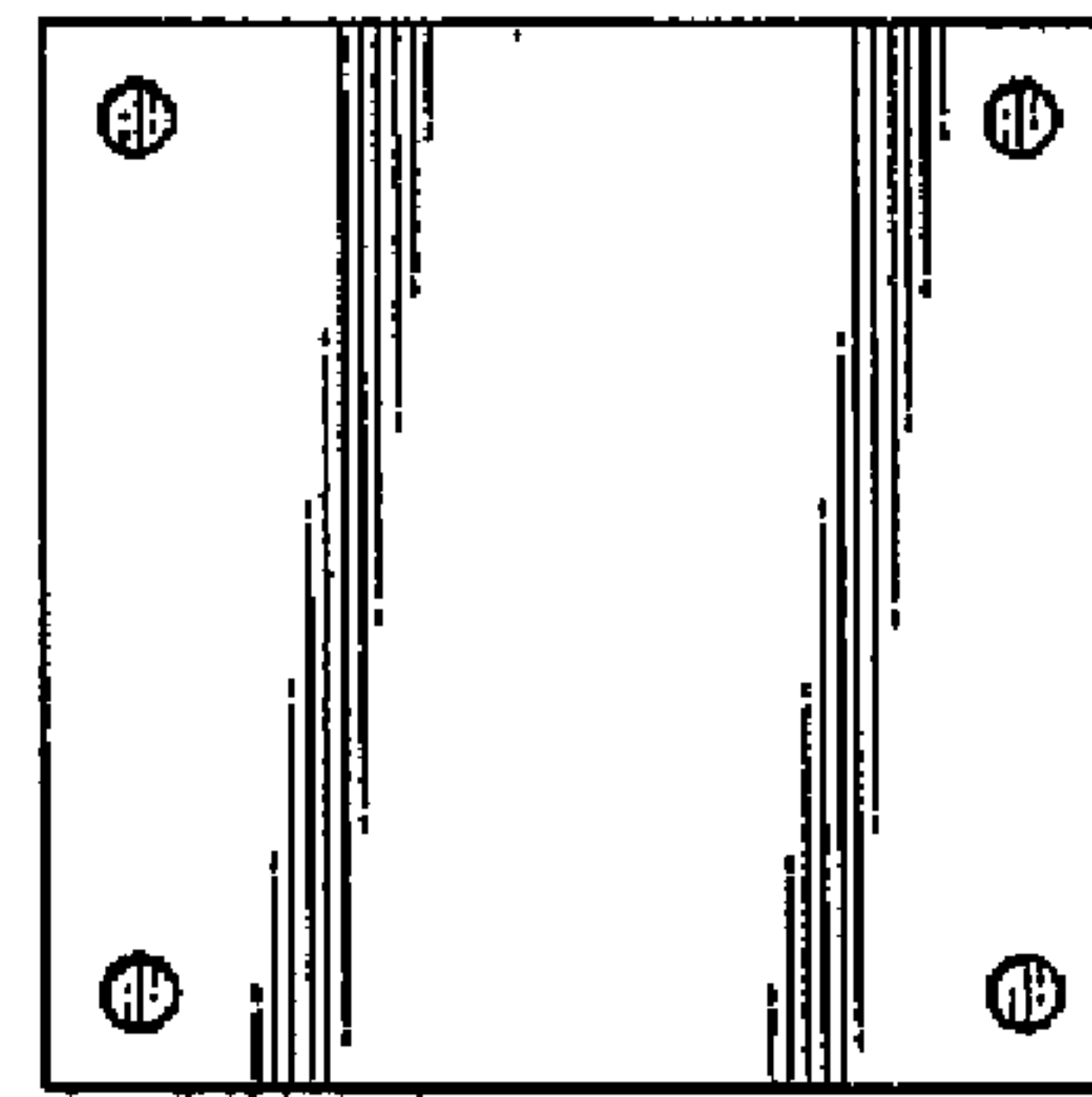

FIG. 17

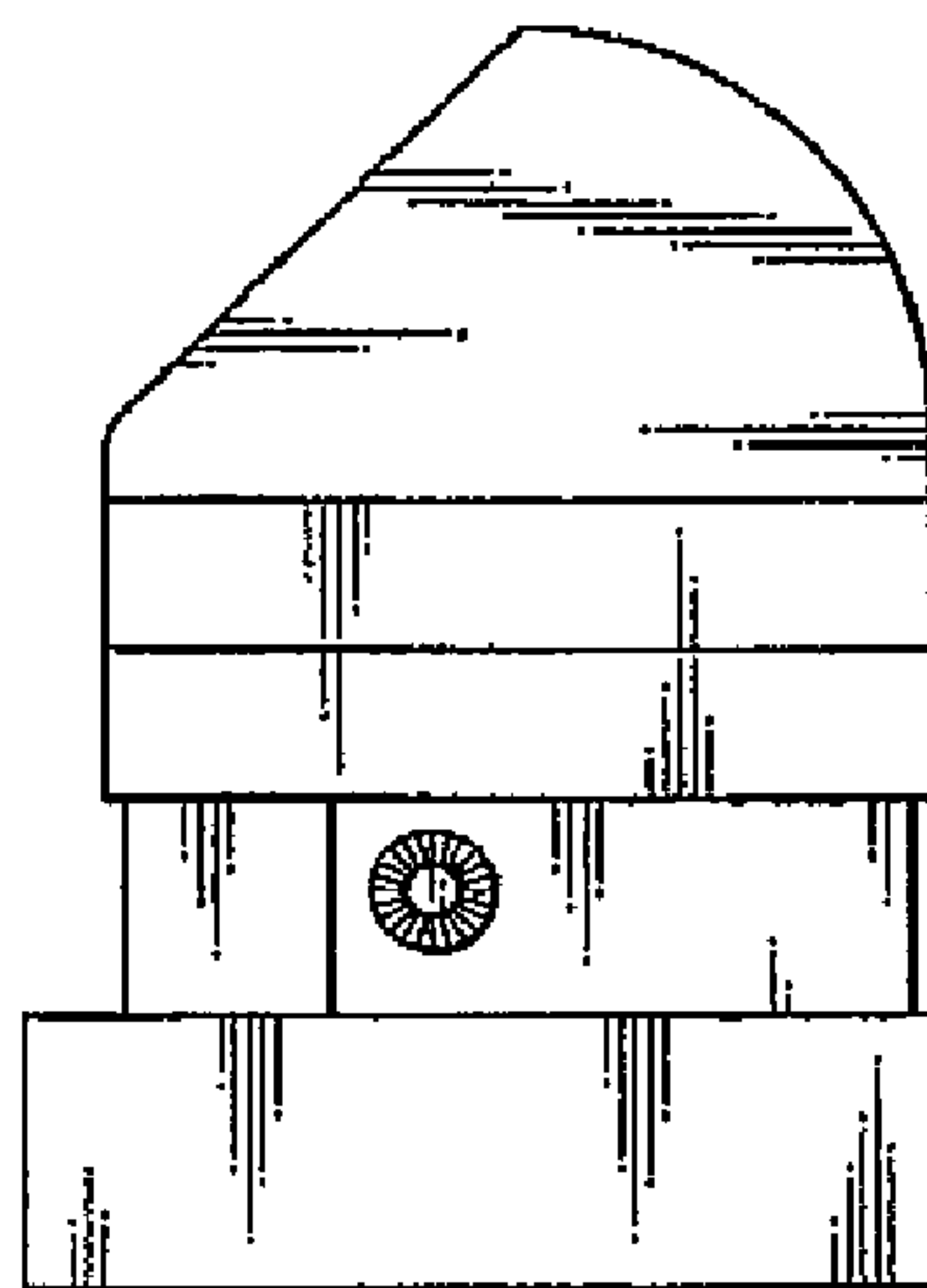

FIG. 18

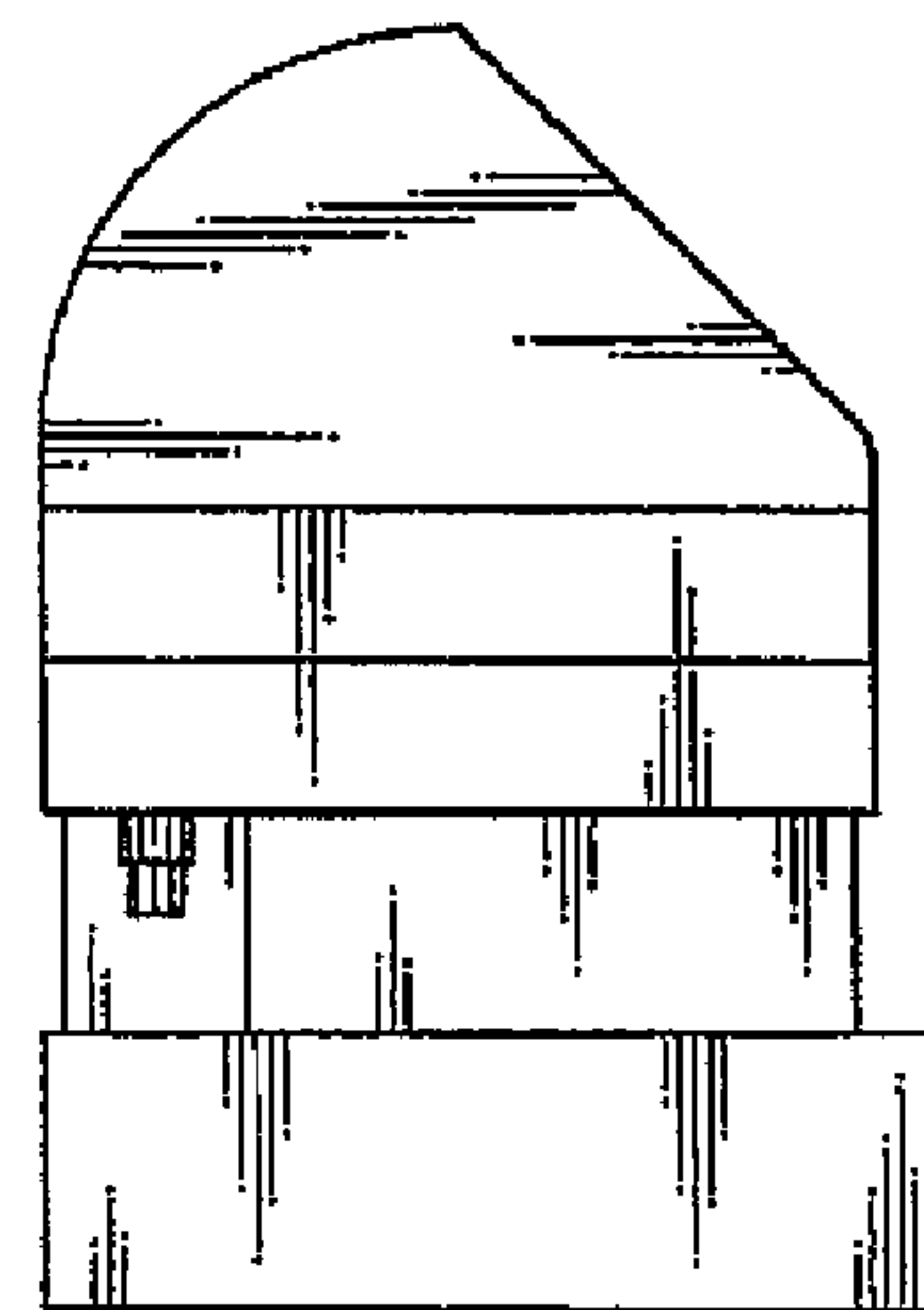

FIG. 19

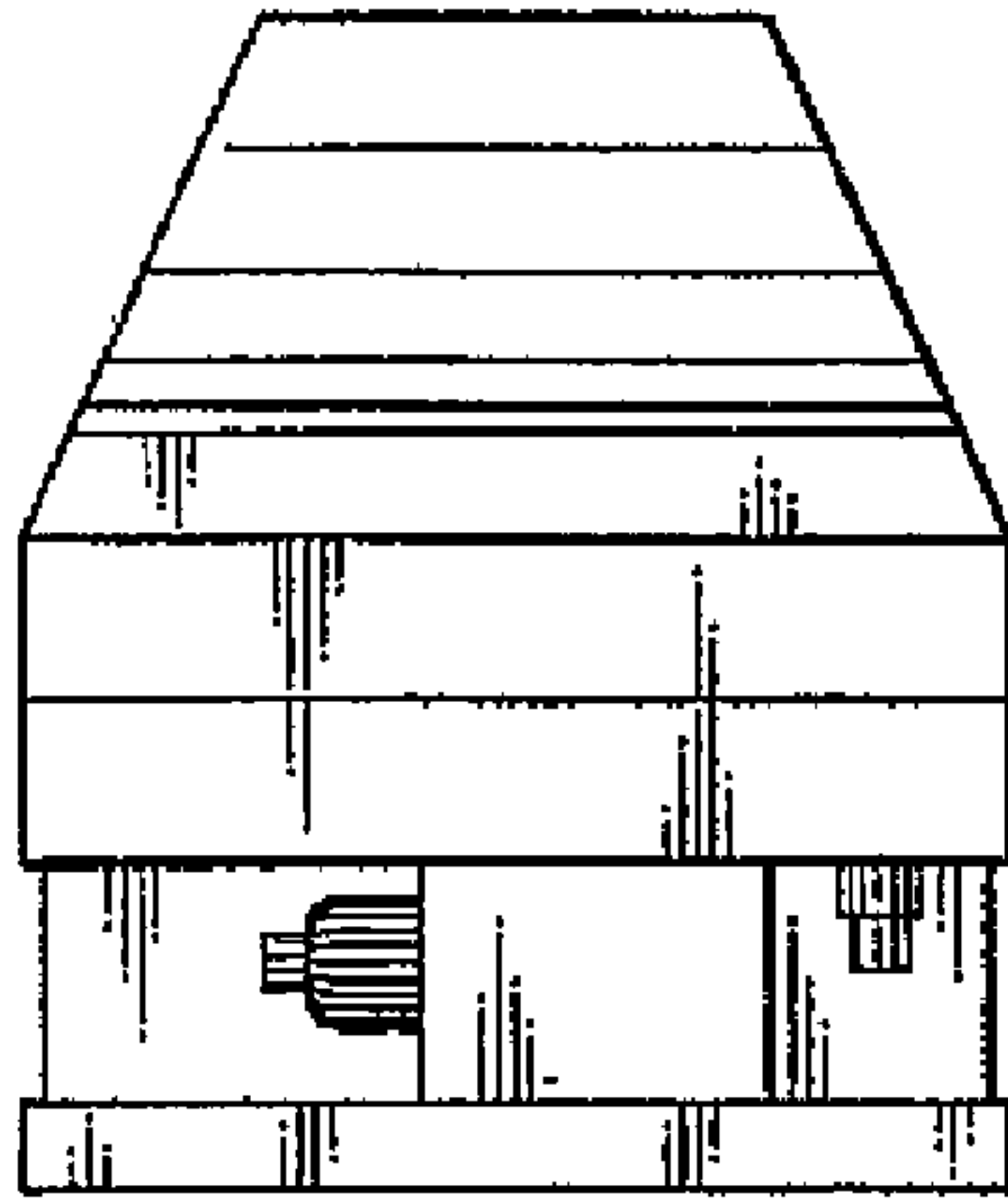

FIG. 20

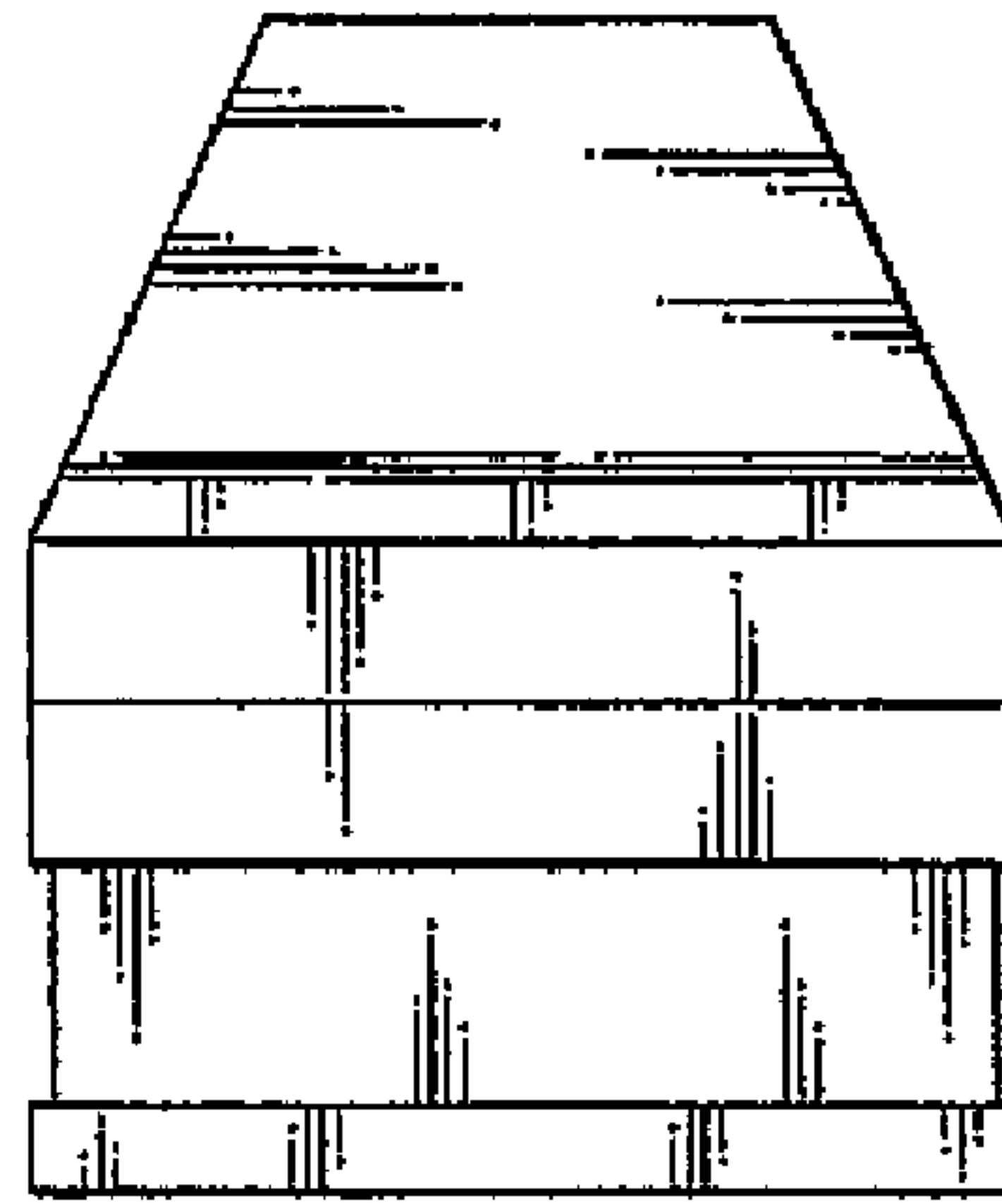

FIG. 21

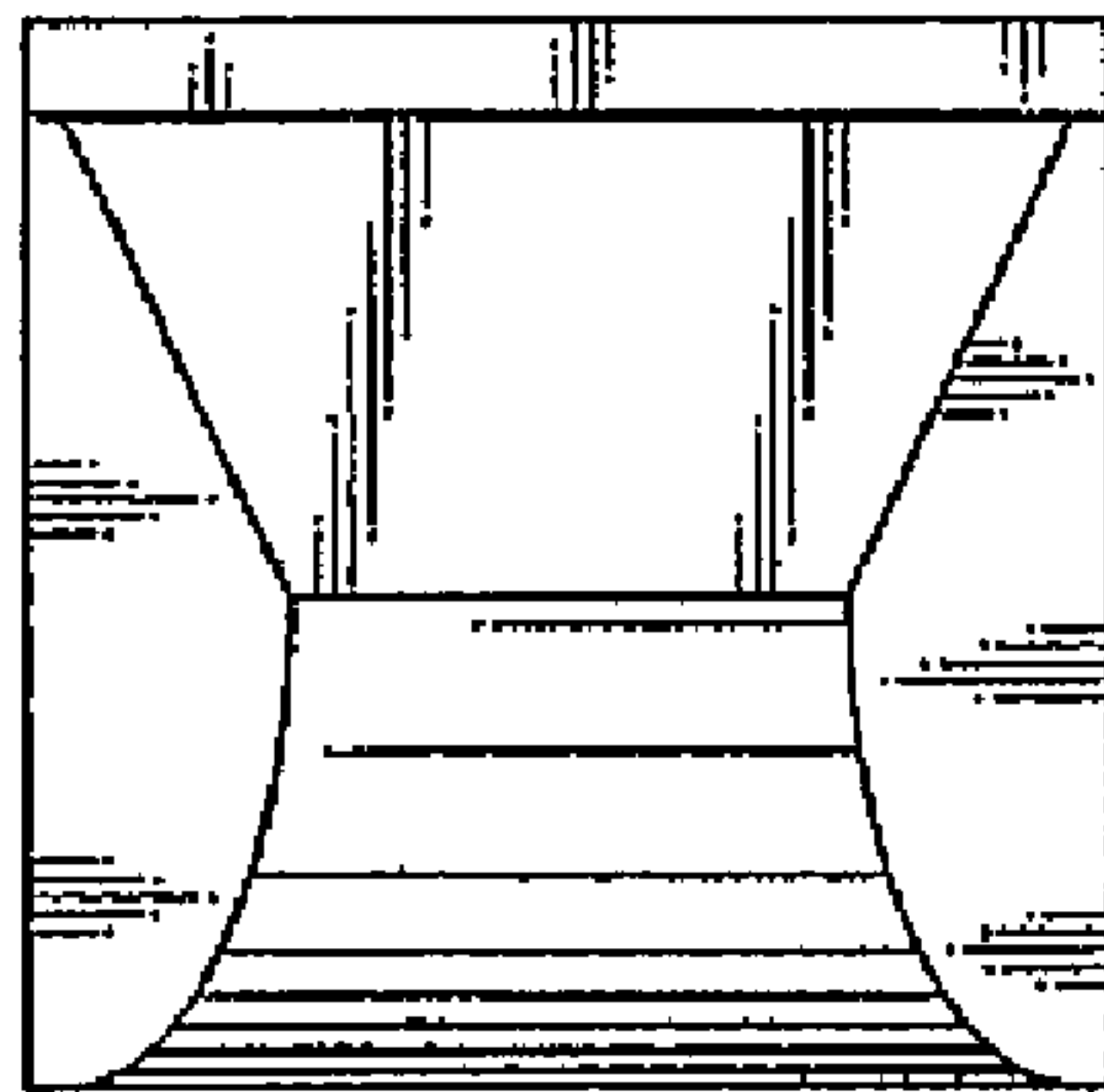

FIG. 22

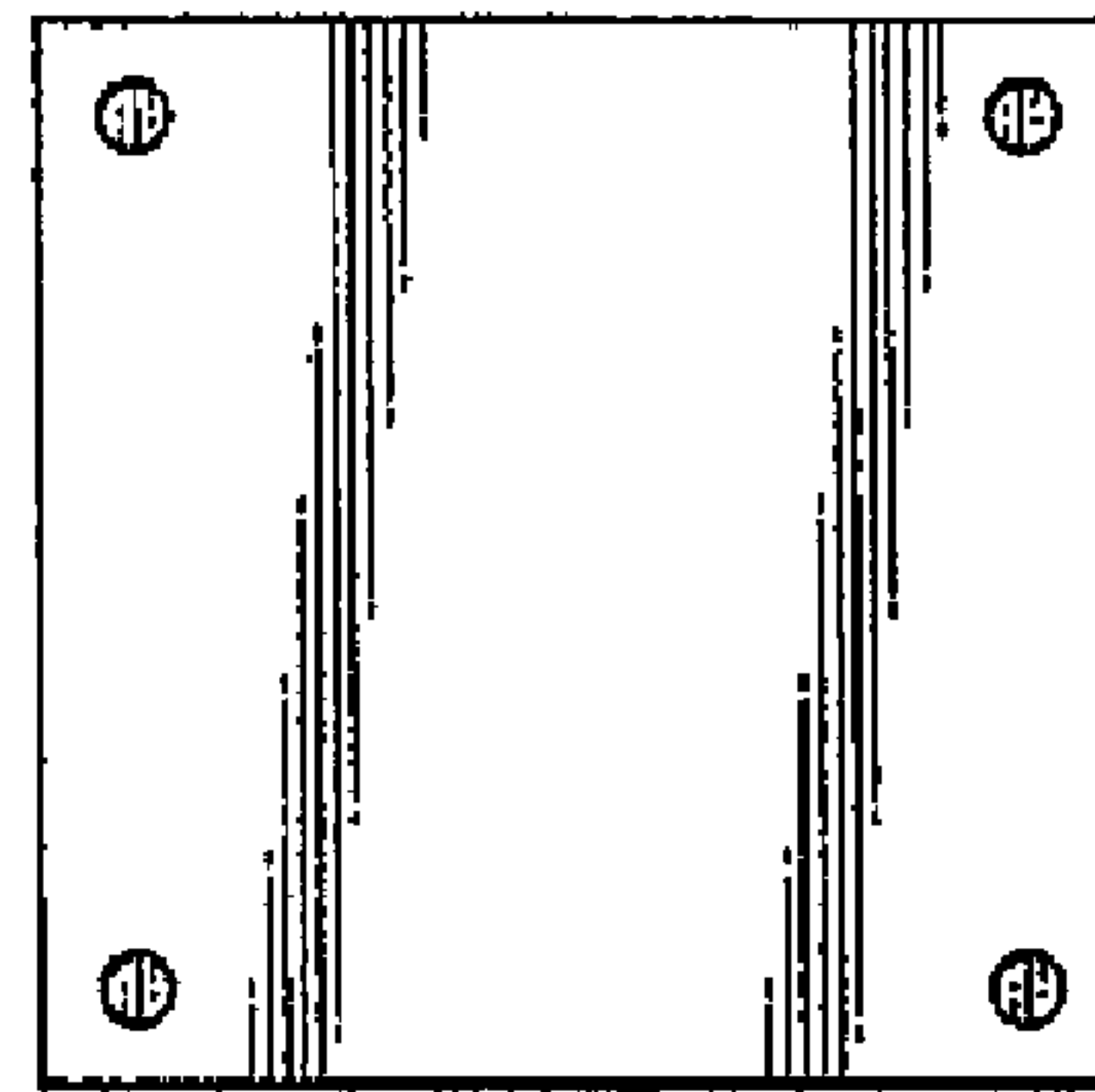

FIG. 23

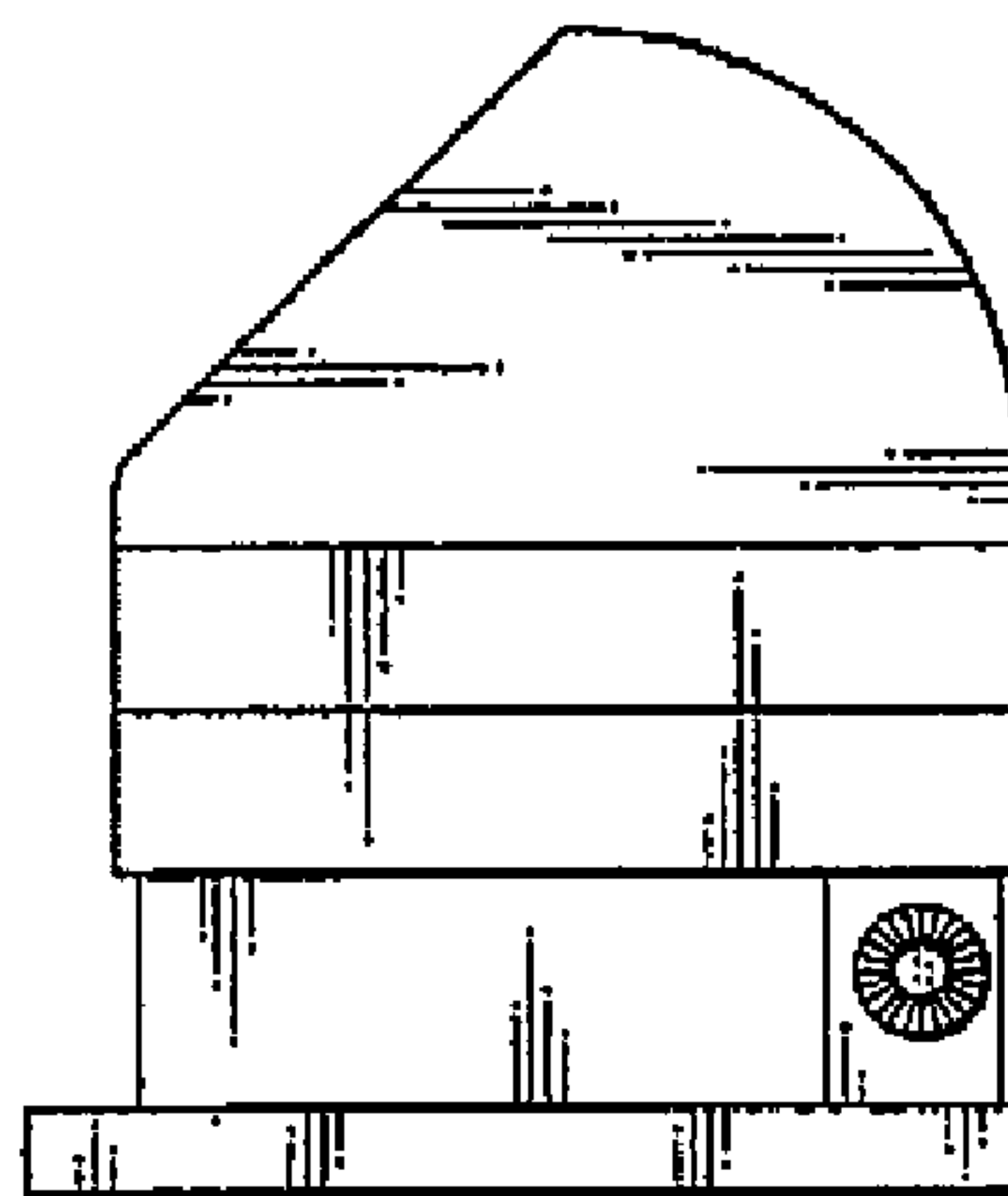

FIG. 24

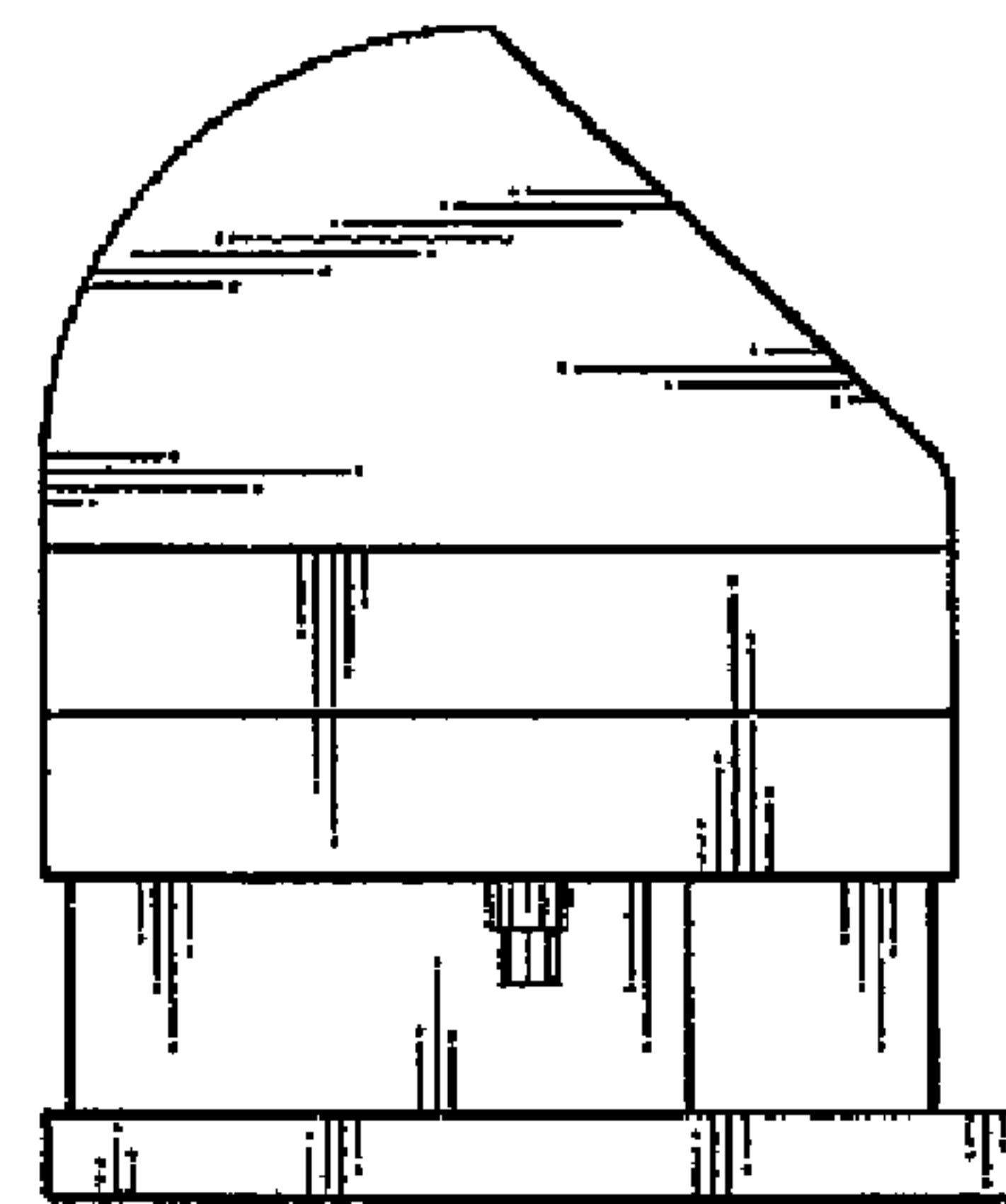

FIG. 25