



US00D575761S

(12) **United States Design Patent**
Kim

(10) **Patent No.:** **US D575,761 S**
(45) **Date of Patent:** **** Aug. 26, 2008**

(54) **MOBILE PHONE**

- (75) Inventor: **Tai Hong Kim**, Seoul (KR)
- (73) Assignee: **LG Electronics Inc.**, Seoul (KR)
- (**) Term: **14 Years**
- (21) Appl. No.: **29/292,794**
- (22) Filed: **Oct. 29, 2007**

(30) **Foreign Application Priority Data**

Jun. 4, 2007 (KR) 30-2007-0024055

- (51) **LOC (8) Cl.** **14-03**
- (52) **U.S. Cl.** **D14/138**
- (58) **Field of Classification Search** D14/137,
D14/138, 147, 191, 218, 247-248, 341-347,
D14/496; D10/65, 78, 104; D13/168; D18/7;
455/556.1, 566, 575.1, 575.3; 345/169
See application file for complete search history.

(56) **References Cited**

U.S. PATENT DOCUMENTS

6,731,267	B1 *	5/2004	Tuoriniemi et al.	345/156
6,756,968	B2 *	6/2004	McAlindon	345/169
D511,342	S *	11/2005	Chien	D14/346
D525,959	S *	8/2006	Kim et al.	D14/138
D529,471	S *	10/2006	Park	D14/138
D531,531	S *	11/2006	Chen	D10/65
D534,143	S *	12/2006	Lheem	D14/138
D534,145	S *	12/2006	Lheem	D14/138
D534,518	S *	1/2007	Choi et al.	D14/138
D535,637	S *	1/2007	Park et al.	D14/138
D536,691	S *	2/2007	Park	D14/138
D538,276	S *	3/2007	Wang	D14/247
D540,204	S *	4/2007	Aguilar	D10/65
D546,313	S *	7/2007	Lheem	D14/138
D549,683	S *	8/2007	Cho et al.	D14/138
D557,244	S *	12/2007	Lee et al.	D14/138

(Continued)

OTHER PUBLICATIONS

- LG KG280, announced Jun. 2007, [online], [retrieved on Sep. 15, 2007]. Retrieved from Internet ,<URL: <http://www.gsmarena.com>>.*
- LG KM500, announced Feb. 2008, [online], [retrieved on Mar. 21, 2008]. Retrieved from Internet ,<URL: <http://www.gsmarena.com>>.*
- Gigabyte g-Smart t600, announced Feb. 2007, [online], [retrieved on Mar. 12, 2007]. Retrieved from Internet ,<URL: <http://www.gsmarena.com>>.*
- Gigabyte g-Smart MW998, announced Feb. 2008, [online], [retrieved on Apr. 4, 2008]. Retrieved from Internet ,<URL: <http://www.gsmarena.com>>.*

(Continued)

Primary Examiner—Jeffrey D. Asch
Assistant Examiner—Bridget L Eland
 (74) *Attorney, Agent, or Firm*—Morgan, Lewis & Bockius LLP

(57) **CLAIM**

The ornamental design for a mobile phone, as shown and described.

DESCRIPTION

FIG. 1 is a perspective view of a mobile phone showing my new design;
 FIG. 2 is a front view thereof;
 FIG. 3 is a rear view thereof;
 FIG. 4 is a left side view thereof;
 FIG. 5 is a right side view thereof;
 FIG. 6 is a top plan view thereof;
 FIG. 7 is a bottom plan view thereof;
 FIG. 8 is a front view thereof in a condition that the upper body thereof has been slid upward and the inner key pad is exposed; and,
 FIG. 9 is an enlarged view taken along line A—A', B—B', C—C' and D—D' of FIG. 2.

1 Claim, 8 Drawing Sheets

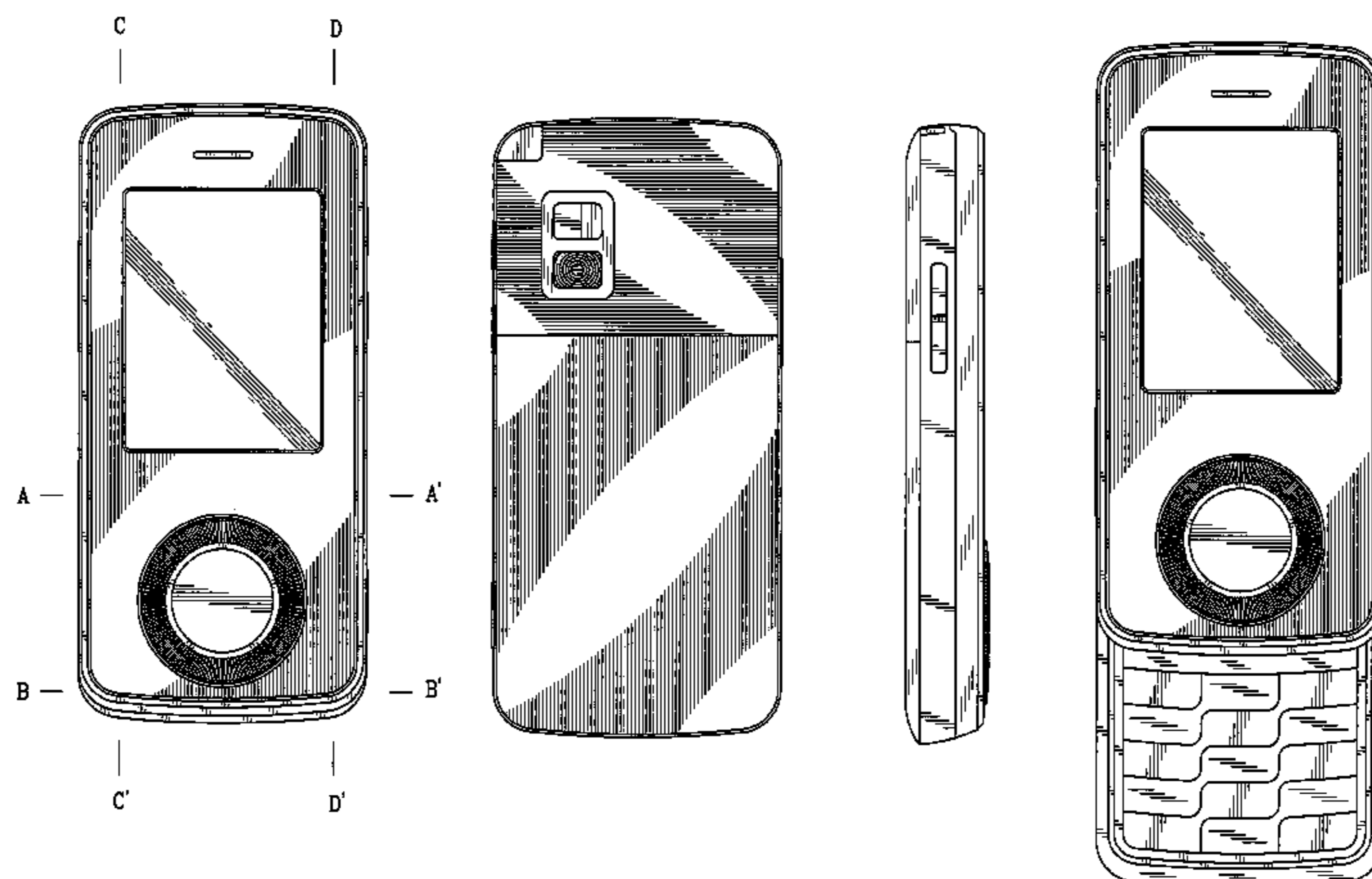

US D575,761 S

Page 2

U.S. PATENT DOCUMENTS

D560,195 S * 1/2008 Moon et al. D14/138
D562,291 S * 2/2008 Bang et al. D14/138
D563,372 S * 3/2008 Park D14/138
D563,929 S * 3/2008 Park D14/138
D569,366 S * 5/2008 Hsu D14/138
2004/0242288 A1* 12/2004 Balle et al. 455/575.1
2007/0020992 A1* 1/2007 Hyun et al. 439/500
2007/0293280 A1* 12/2007 Nieuwenhuizen 455/575.1
2007/0296704 A1* 12/2007 Park et al. 345/169

2008/0058022 A1* 3/2008 Ahn 455/566

OTHER PUBLICATIONS

Pantech PG-3060V, announced Feb. 2006, [online], [retrieved on Feb. 20, 2007]. Retrieved from Internet ,<URL: <http://www.gsmarena.com>>.*

LG KM710, announced Feb. 2008, [online], [retrieved on May 22, 2008]. Retrieved from Internet ,<URL: <http://www.gsmarena.com>>.*

* cited by examiner

FIG. 1

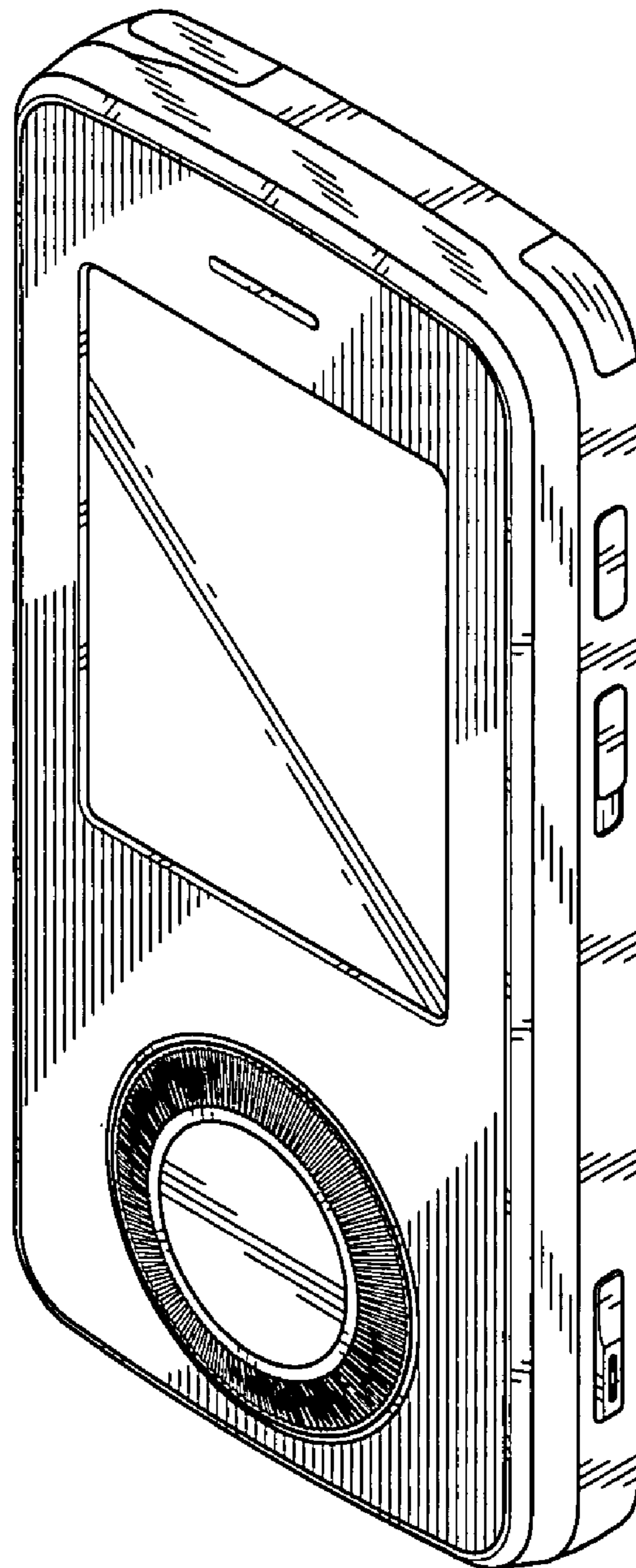

FIG. 2

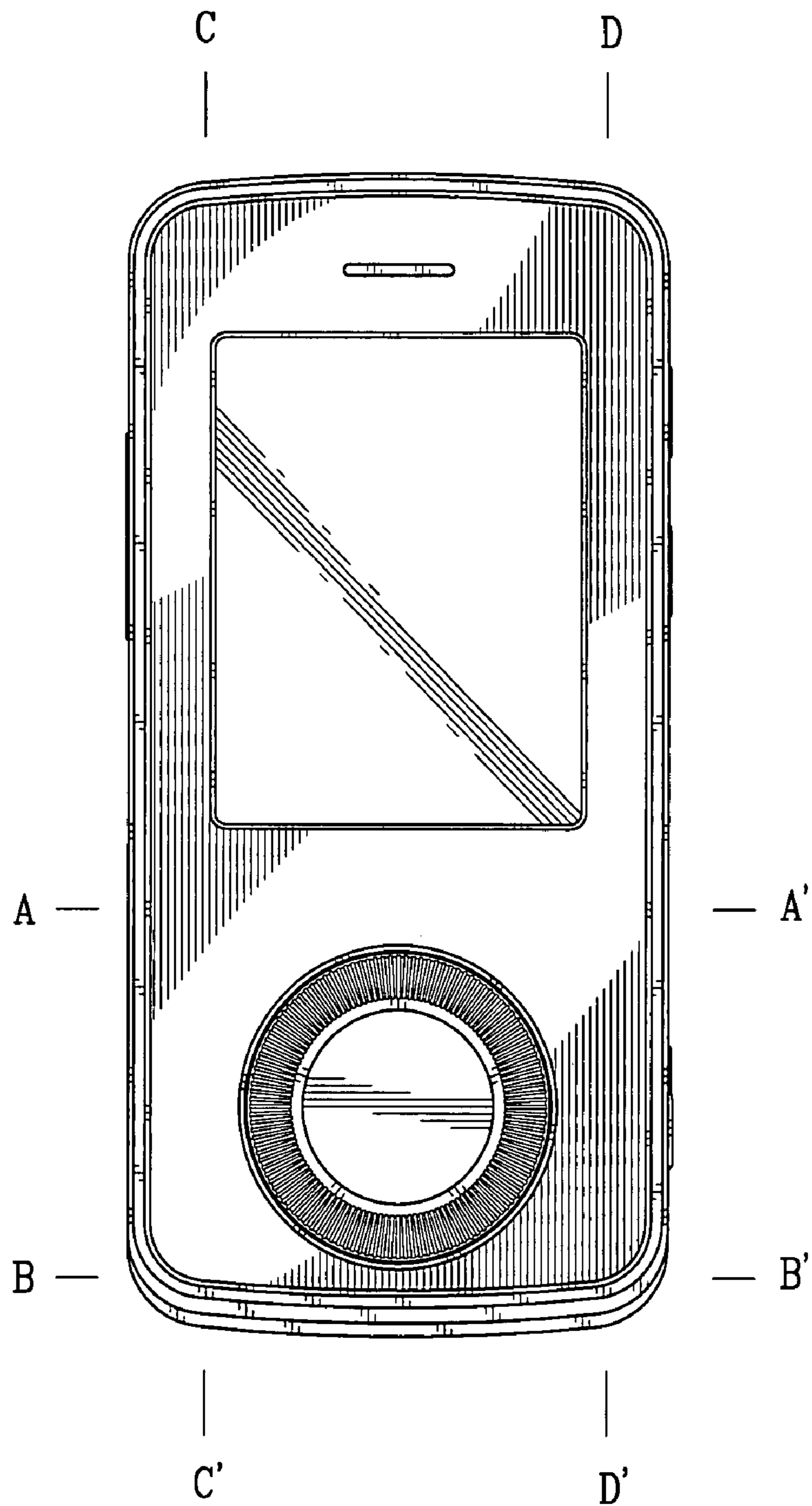

FIG. 3

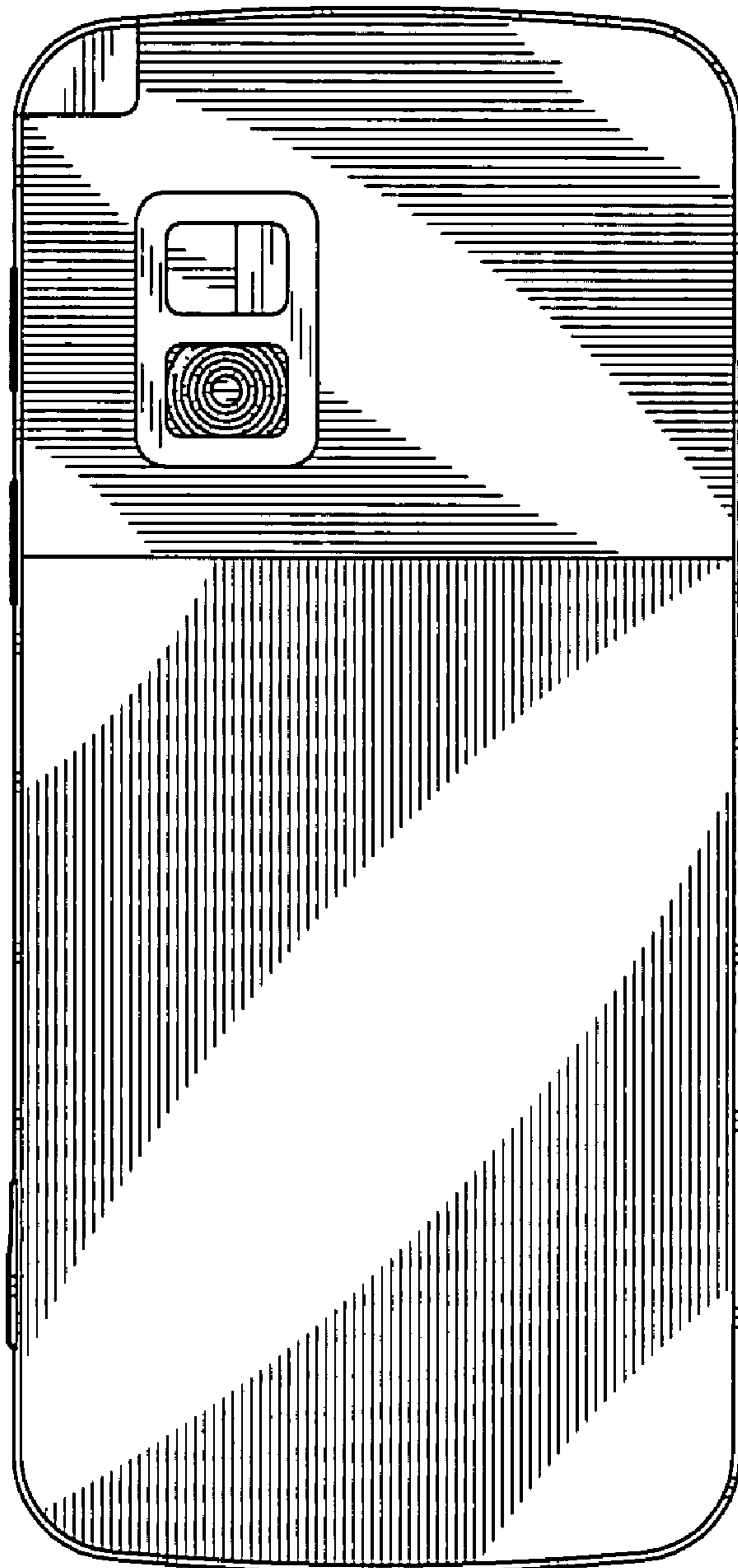

FIG. 4

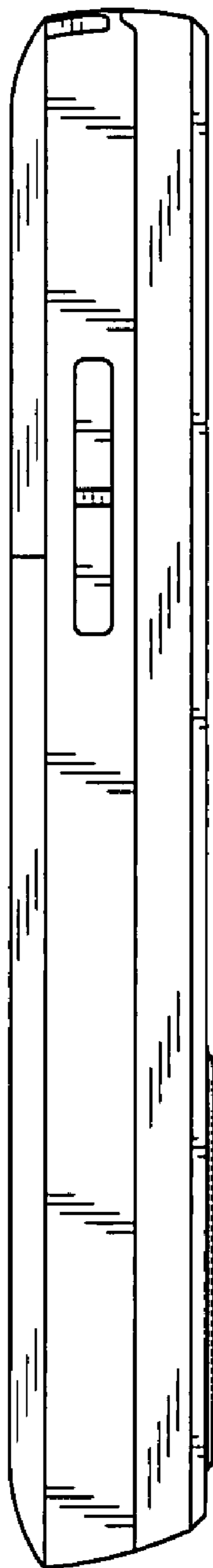

FIG. 5

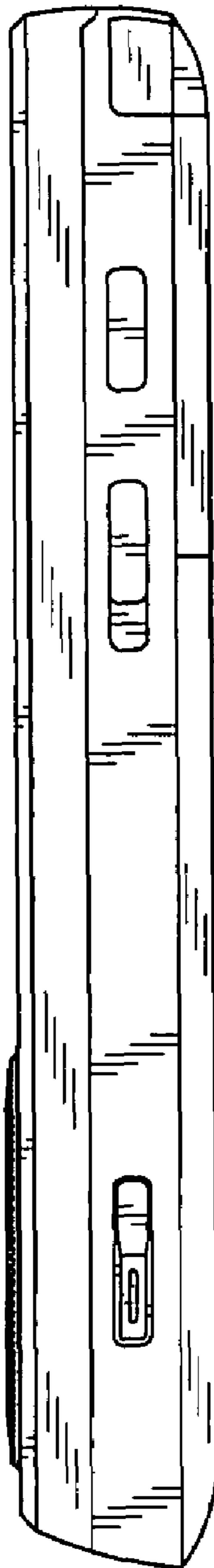

FIG. 6

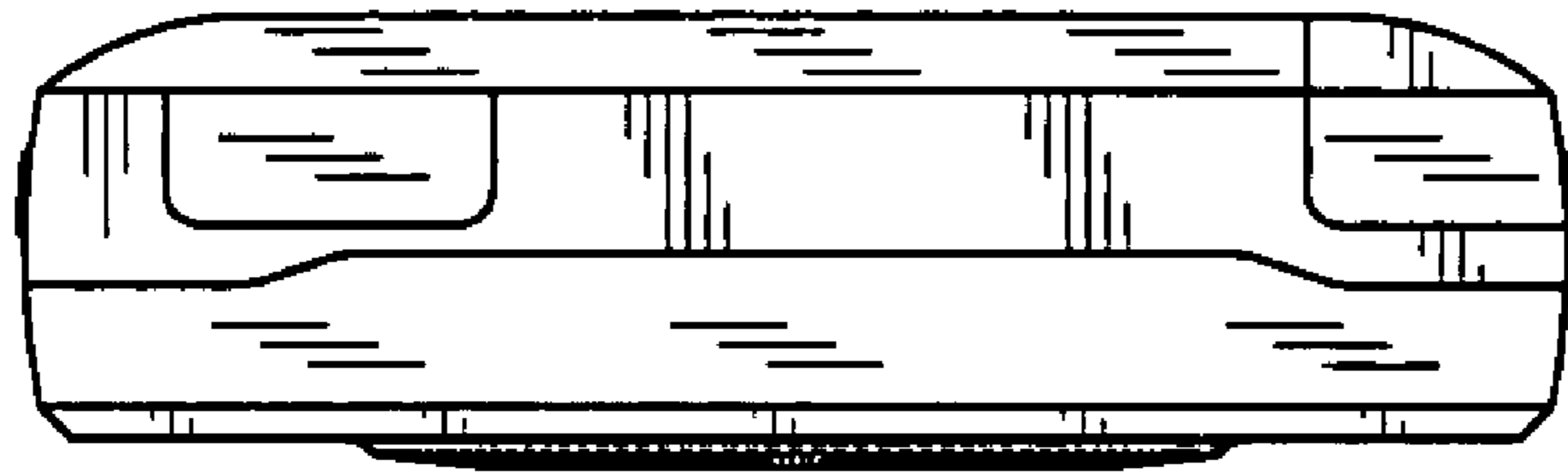

FIG. 7

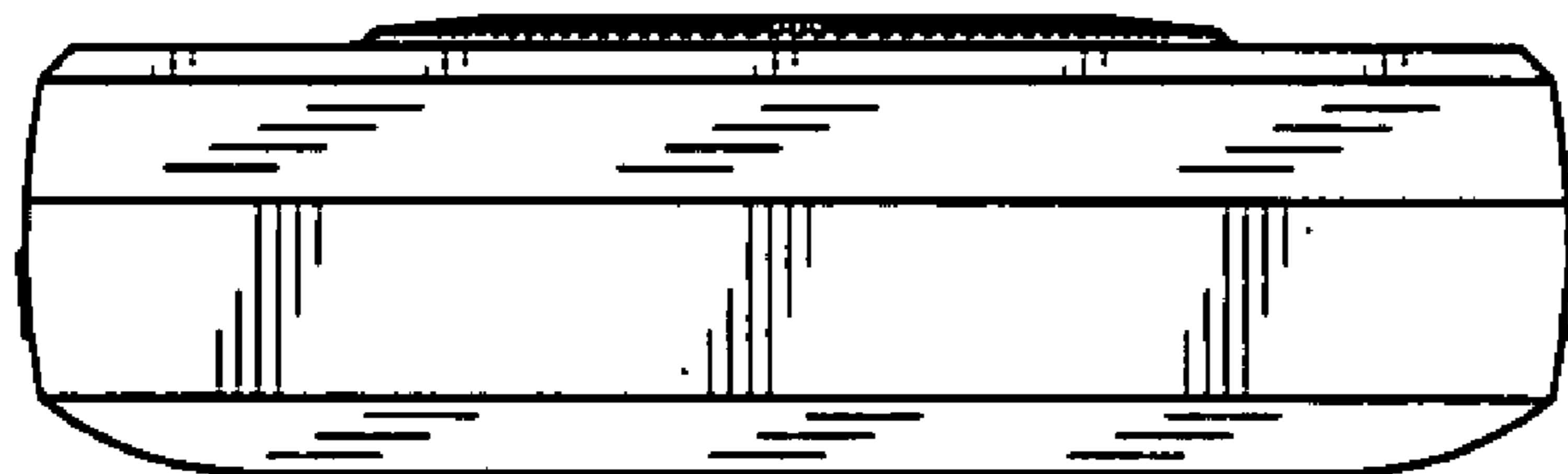

FIG. 8

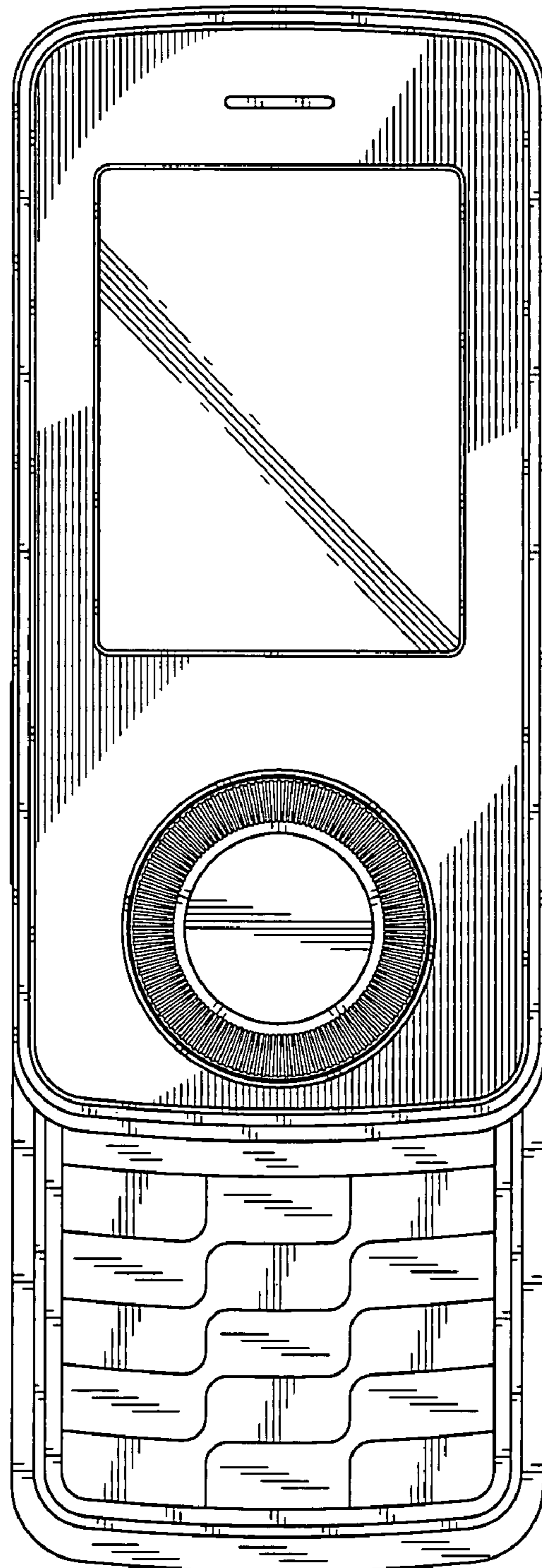

FIG. 9

