



US00D575735S

(12) **United States Design Patent**
Foreman et al.

(10) **Patent No.:** **US D575,735 S**
(45) **Date of Patent:** **** Aug. 26, 2008**

(54) **BATTERY HOLDER**

(75) Inventors: **Richard Foreman**, Wayne, IL (US);
Kathleen Foreman, Wayne, IL (US);
Timothy Moreau, DeKalb, IL (US);
Brad Cherkas, Etobicoke (CA)

(73) Assignee: **Tools Aviation, LLC**, St. Charles, IL (US)

(**) Term: **14 Years**

(21) Appl. No.: **29/288,956**

(22) Filed: **Jun. 28, 2007**

(51) **LOC (8) Cl.** **13-02**

(52) **U.S. Cl.** **D13/119**

(58) **Field of Classification Search** D13/103,
D13/118-119, 184; D3/304, 313, 315; 206/703-705,
206/461, 462, 471, 477, 485
See application file for complete search history.

(56) **References Cited**

U.S. PATENT DOCUMENTS

D197,862 S *	3/1964	Cohasset et al.	D9/415
D211,640 S *	7/1968	Hugues	D13/119
D222,580 S *	11/1971	Nakakuma	D9/415
D222,581 S *	11/1971	Nakakuma	D9/415
4,510,215 A	4/1985	Adam		
D326,200 S *	5/1992	Allen et al.	D6/479
5,137,693 A	8/1992	Mawhirt		
5,379,894 A *	1/1995	Haas et al.	206/705
D372,701 S *	8/1996	Tahmassebpur	D13/103
D380,611 S *	7/1997	Mancusi	D3/284
5,855,422 A	1/1999	Naef		
5,866,276 A	2/1999	Ogami et al.		
D409,559 S	5/1999	Shim		
D409,560 S	5/1999	Shim		
5,947,297 A *	9/1999	Aoki et al.	206/705
6,174,618 B1	1/2001	Nishiyama et al.		
6,364,115 B1 *	4/2002	Casanova et al.	206/471

6,419,091 B1 *	7/2002	Gaffney et al.	206/703
D477,531 S	7/2003	Wilczewski		
D483,722 S *	12/2003	Bailey	D13/119
6,677,728 B2	1/2004	Takedomi et al.		
D488,443 S *	4/2004	Bailey	D13/119
D489,684 S *	5/2004	Takeshima et al.	D13/119
D490,057 S *	5/2004	Takeshima et al.	D13/119
7,287,648 B2 *	10/2007	Foreman et al.	206/703
2001/0046624 A1	11/2001	Goto et al.		
2004/0112790 A1 *	6/2004	Lee et al.	206/703
2006/0000738 A1 *	1/2006	Kumakura et al.	206/470
2007/0051663 A1 *	3/2007	Foreman et al.	206/703

OTHER PUBLICATIONS

Prior Sale of Tools Aviation, LLC Model 1792-original (2 sheets).
Prior sale of Tools Aviation, LLC model 1850-a9 (2 sheets).
Prior sale of Tools Aviation, LLC model 1854-dc (2 sheets).

* cited by examiner

Primary Examiner—Robin V. Webster

Assistant Examiner—Rosemary K Tarcza

(74) *Attorney, Agent, or Firm*—The Law Office of Randall T. Erickson, PC

(57) **CLAIM**

The ornamental design for a battery holder, as shown and described.

DESCRIPTION

FIG. 1 is a top, front perspective view of the battery holder of the present invention;

FIG. 2 is a front view of the battery holder of FIG. 1;

FIG. 3 is a rear view of the battery holder of FIG. 2;

FIG. 4 is a top view of the battery holder of FIG. 2;

FIG. 5 is a bottom view of the battery holder of FIG. 2;

FIG. 6 is a right side view of the battery holder of FIG. 2; and,

FIG. 7 is a left side view of the battery holder of FIG. 2.

1 Claim, 3 Drawing Sheets

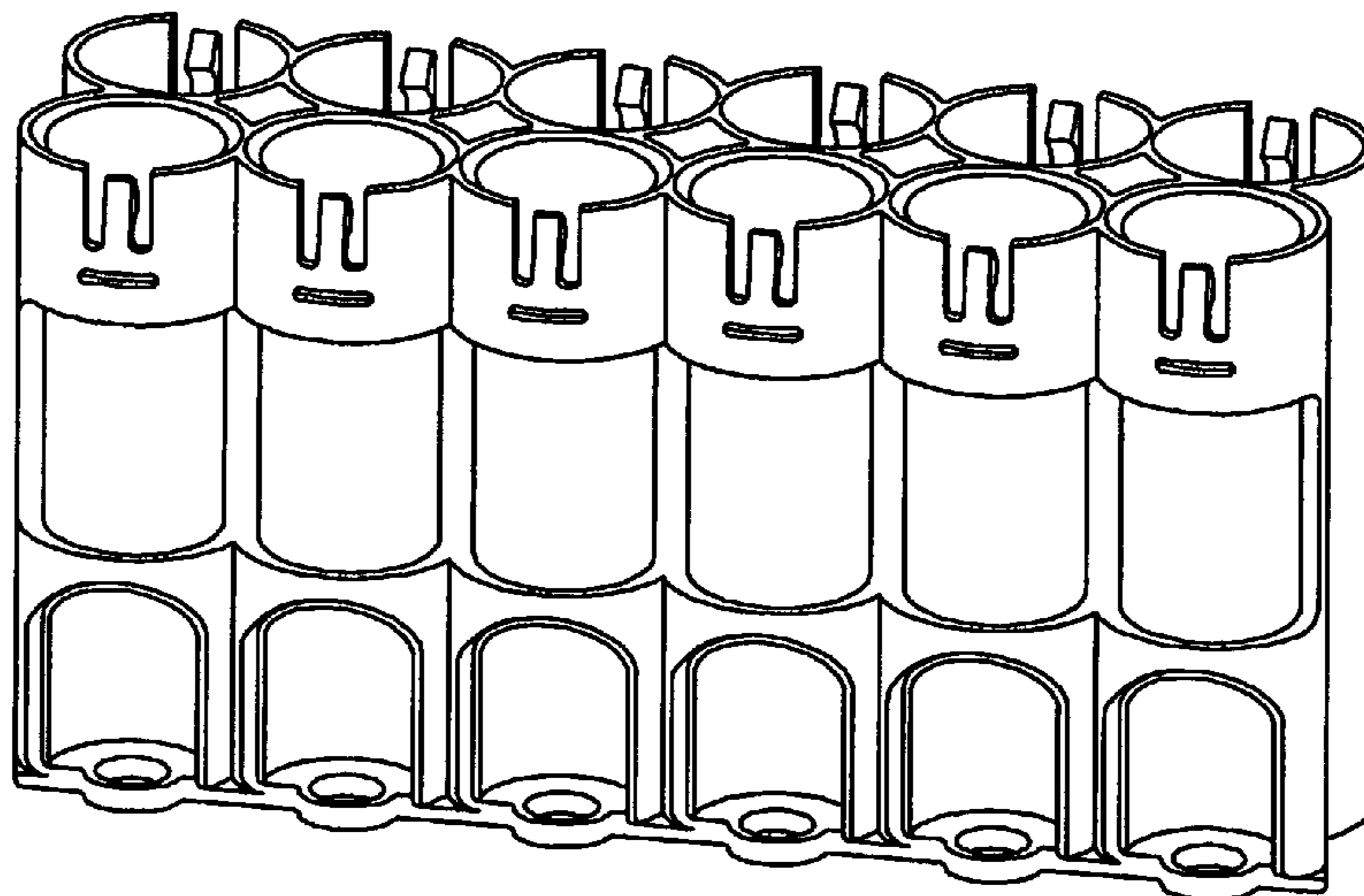

FIG. 1

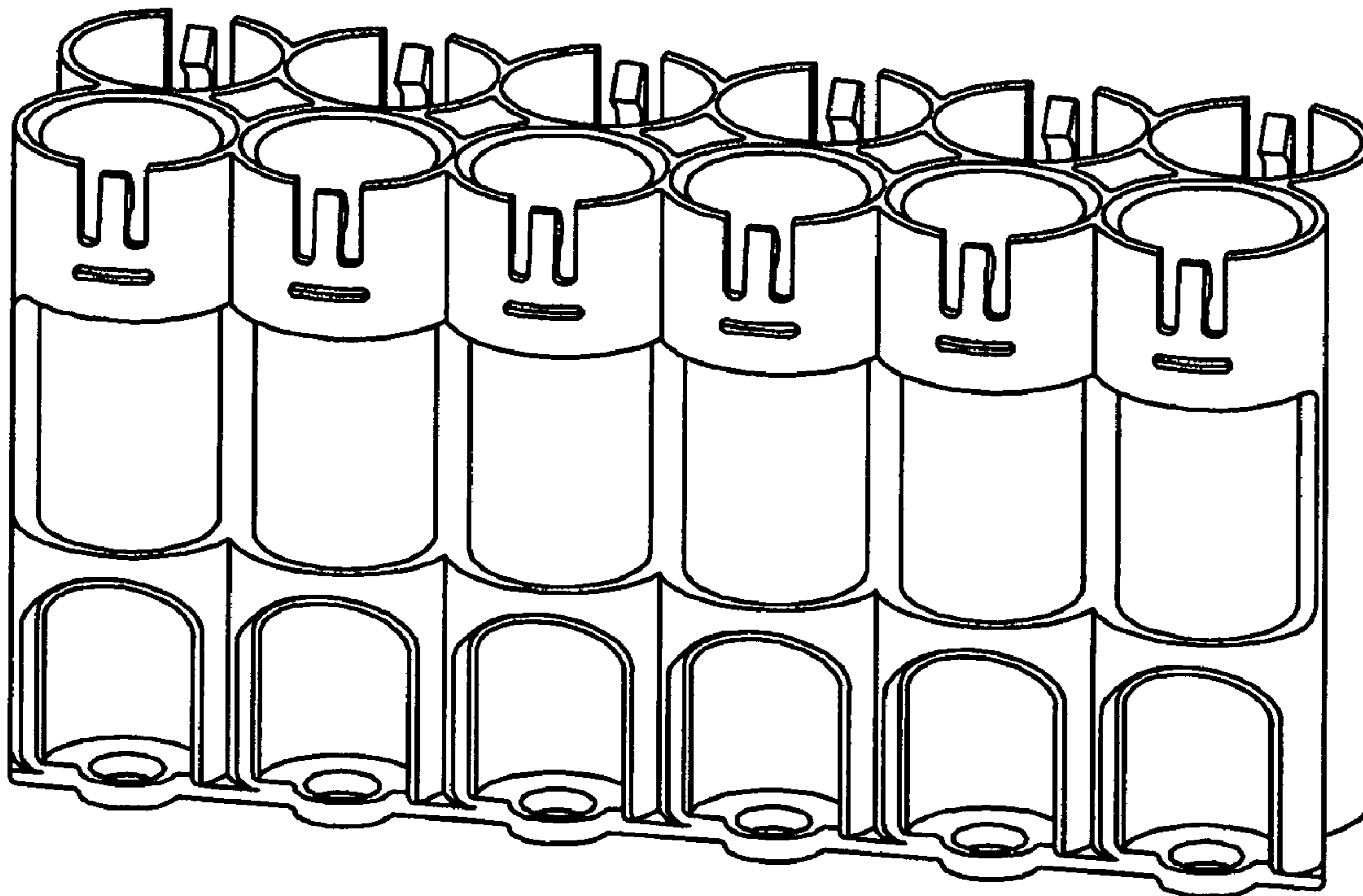

FIG. 2

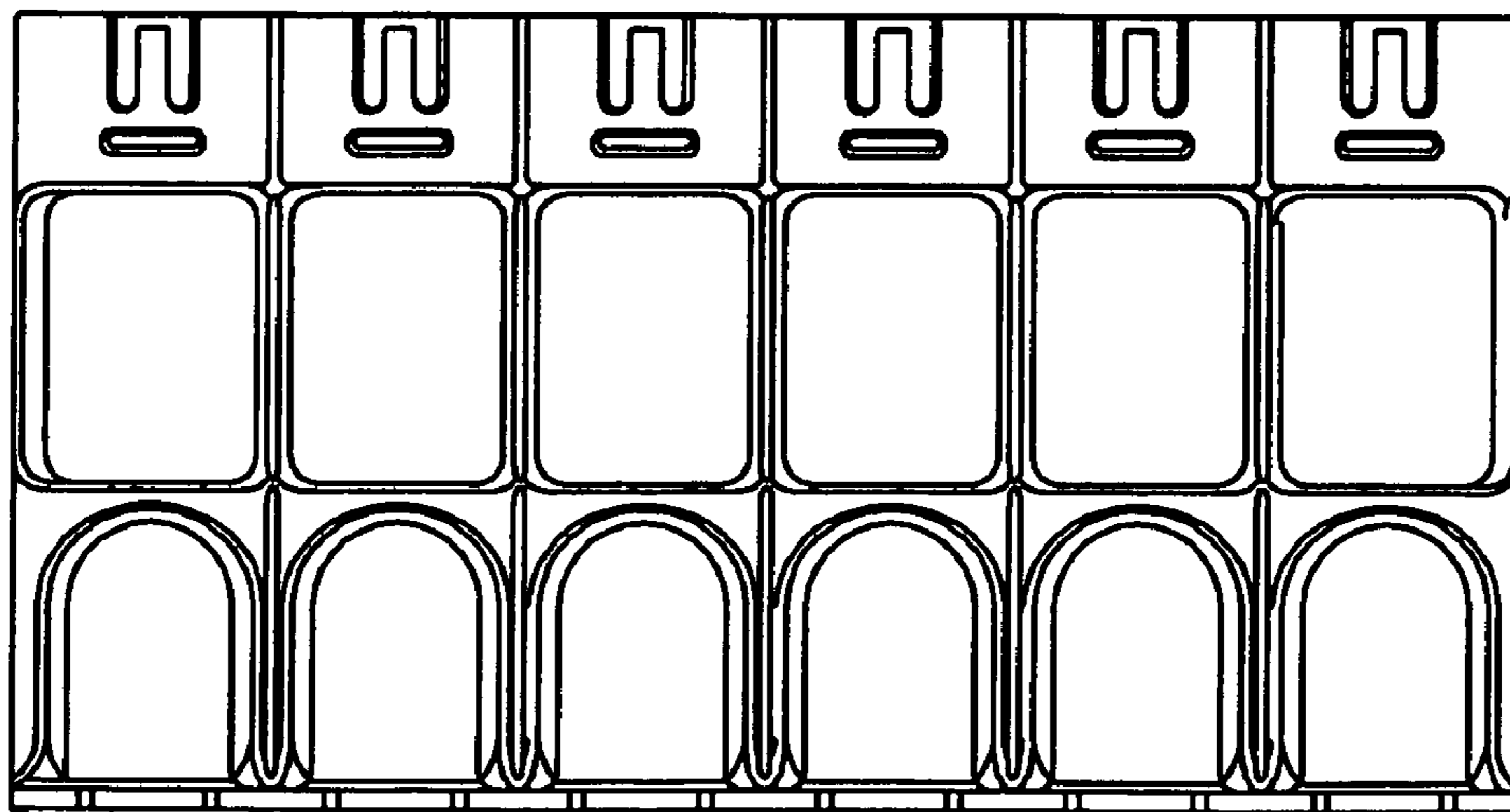

FIG. 3

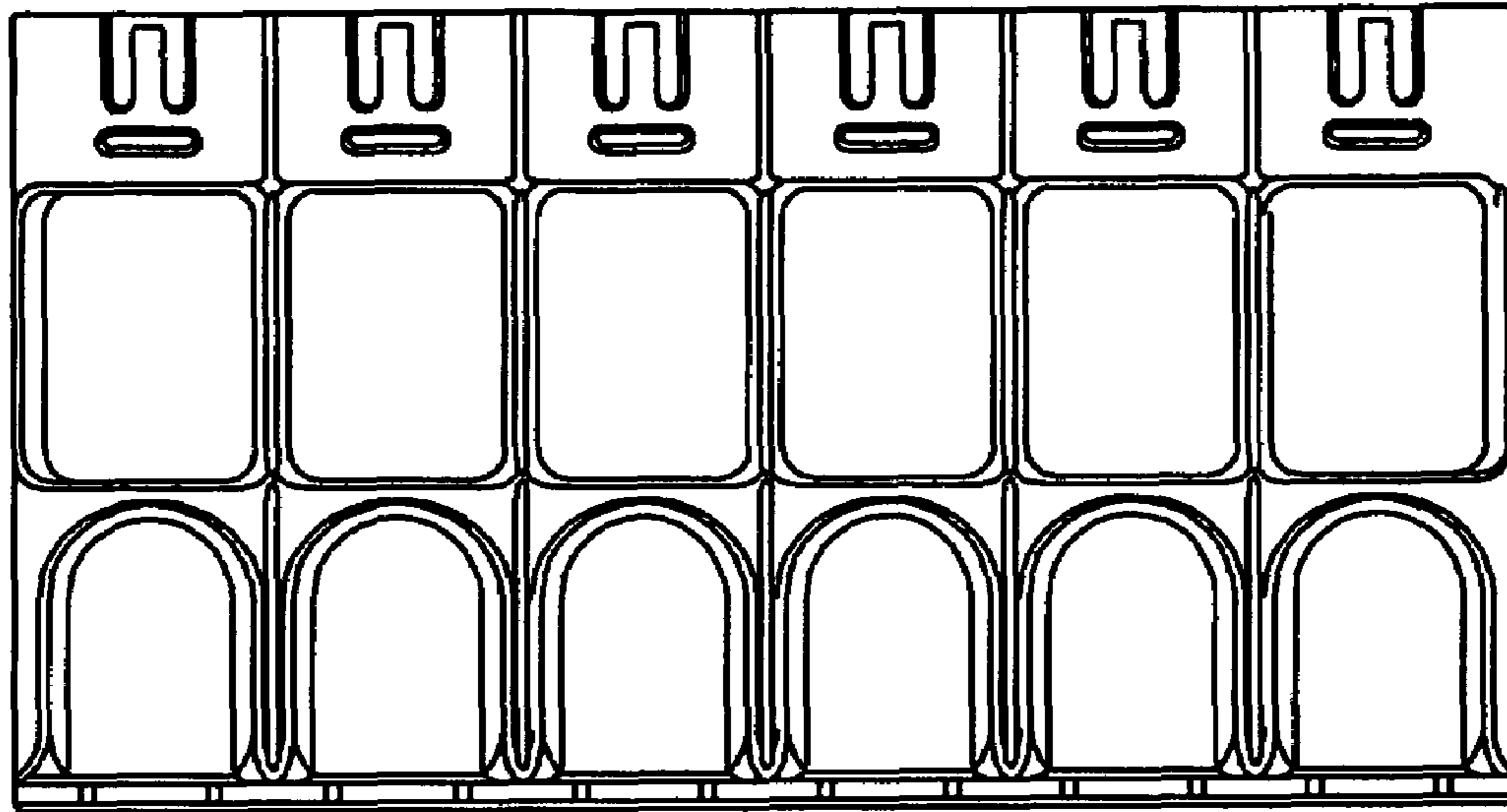

FIG. 4

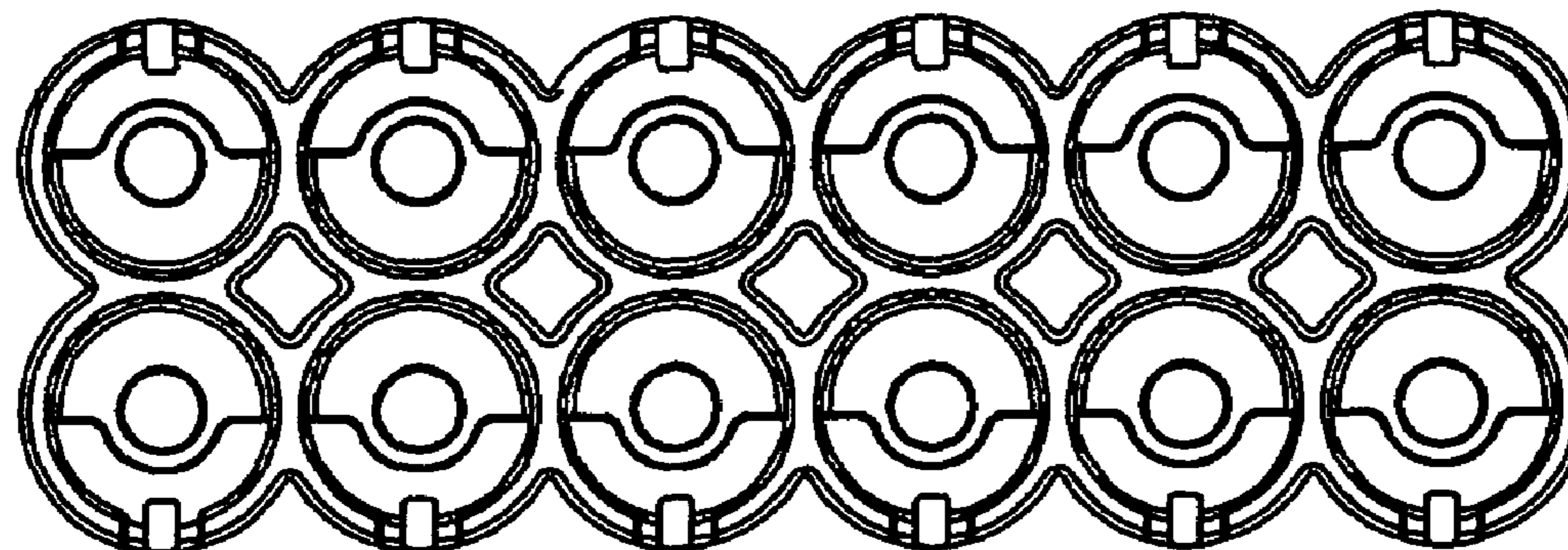

FIG. 5

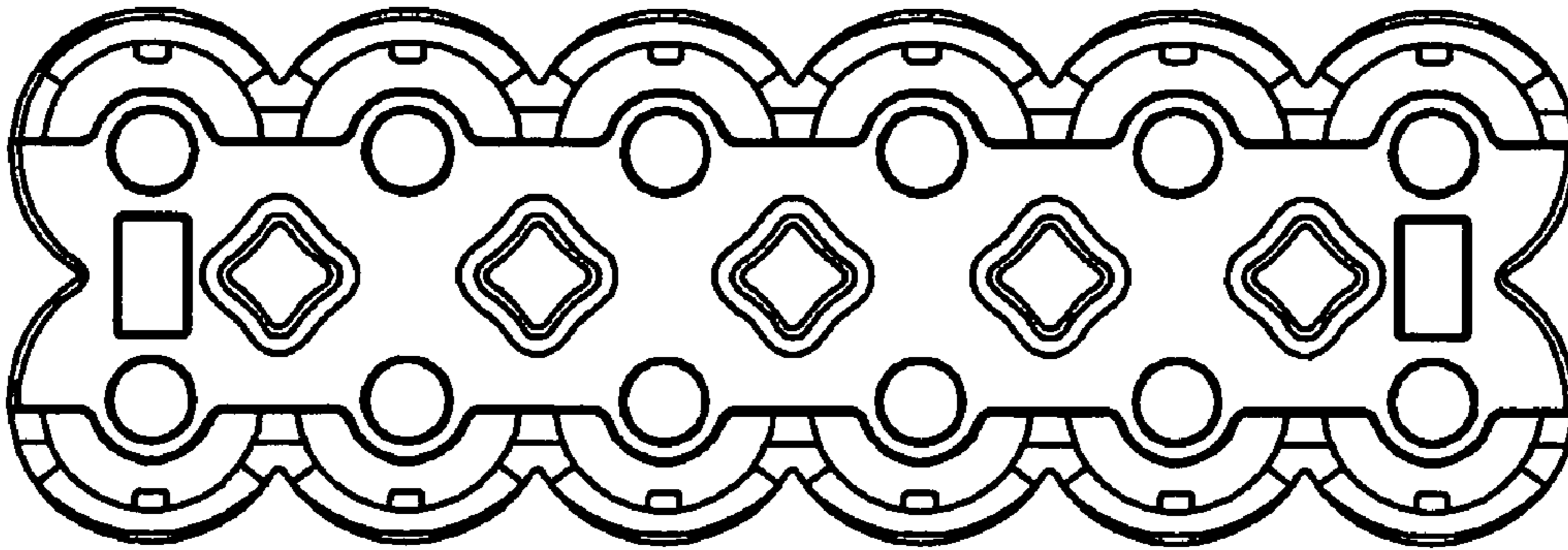

FIG. 6

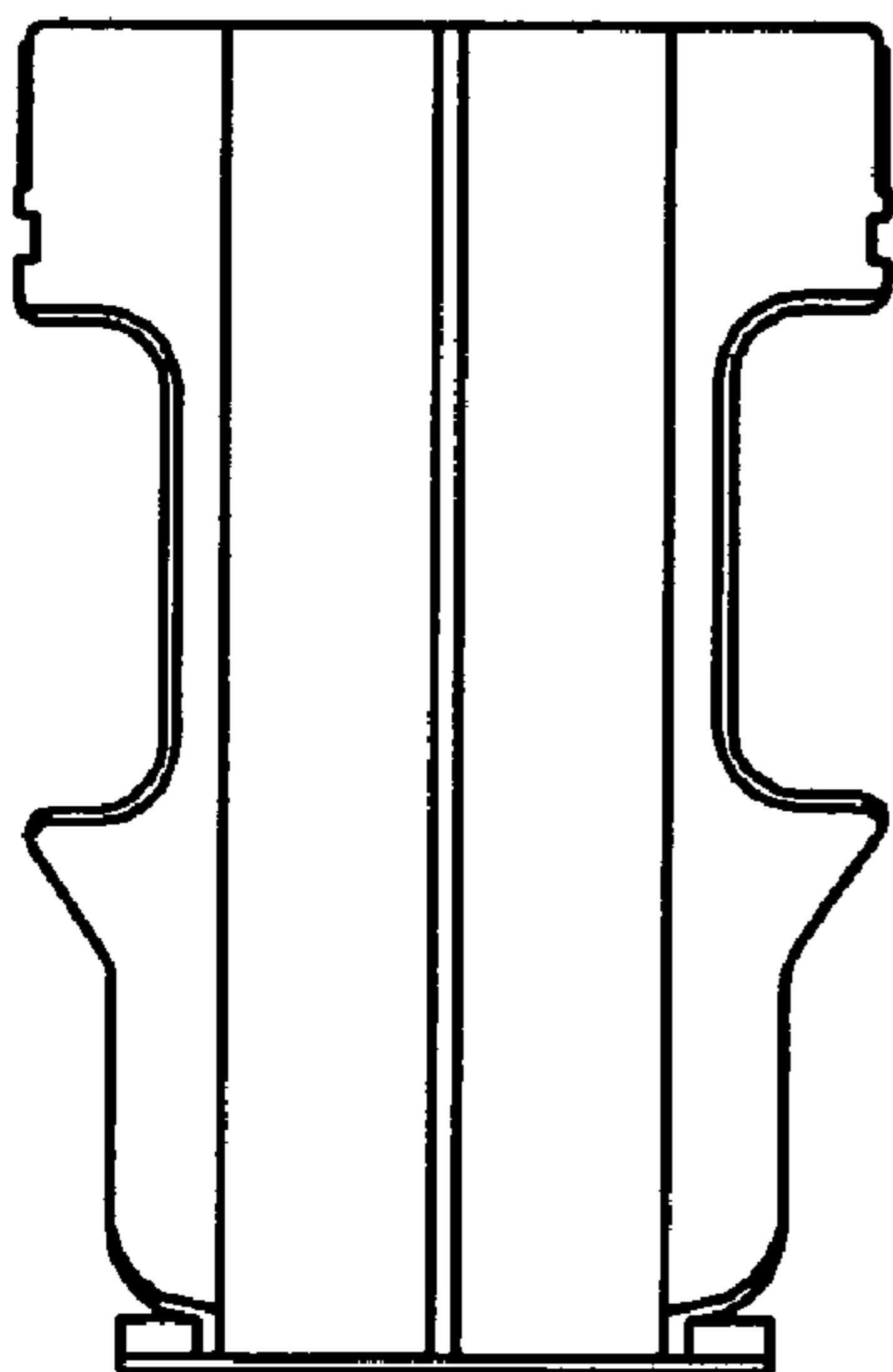

FIG. 7

