



US00D575719S

(12) **United States Design Patent**  
**Goodwin**

(10) **Patent No.:** **US D575,719 S**

(45) **Date of Patent:** **\*\* Aug. 26, 2008**

(54) **TEE HANDLE SCREW-IN BOAT ANCHOR**

(76) Inventor: **Timothy Mark Goodwin**, HC 63 Box  
10Z, Eufaula, OK (US) 74432

(\*\*) Term: **14 Years**

(21) Appl. No.: **29/281,116**

(22) Filed: **Jun. 15, 2007**

(51) **LOC (8) Cl.** ..... **12-16**

(52) **U.S. Cl.** ..... **D12/215**

(58) **Field of Classification Search** ..... D12/215;  
114/294, 298

See application file for complete search history.

(56) **References Cited**

**U.S. PATENT DOCUMENTS**

3,030,907 A \* 4/1962 Rosselle ..... 114/299  
D445,393 S \* 7/2001 Dallavalle ..... D12/215

\* cited by examiner

*Primary Examiner*—Lisa P Lichtenstein

(74) *Attorney, Agent, or Firm*—Christopher Wood; Wood &  
Eisenberg, PLLC

(57) **CLAIM**

The ornamental design for a tee handle screw-in boat anchor,  
as shown and described.

**DESCRIPTION**

FIG. 1 is a perspective view of a tee handle screw-in boat anchor showing my new design;

FIG. 2 is a front view thereof;

FIG. 3 is a rear view thereof;

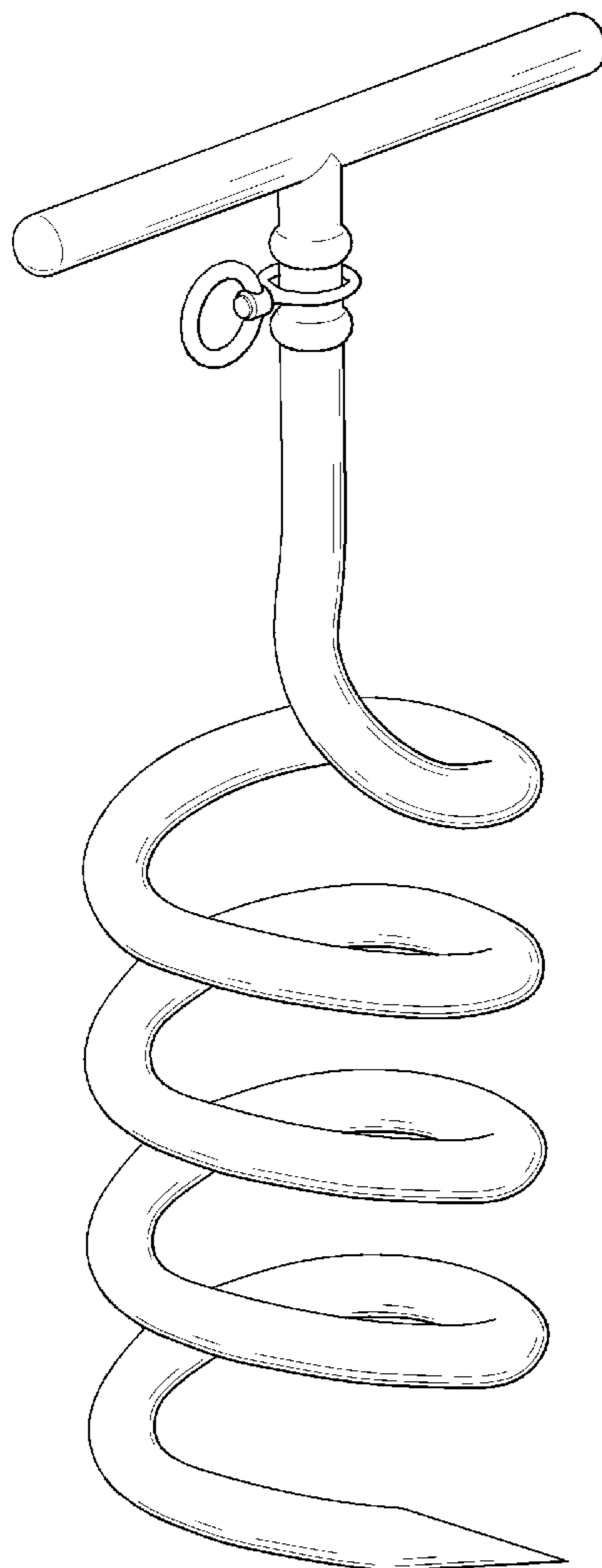
FIG. 4 is a top view thereof;

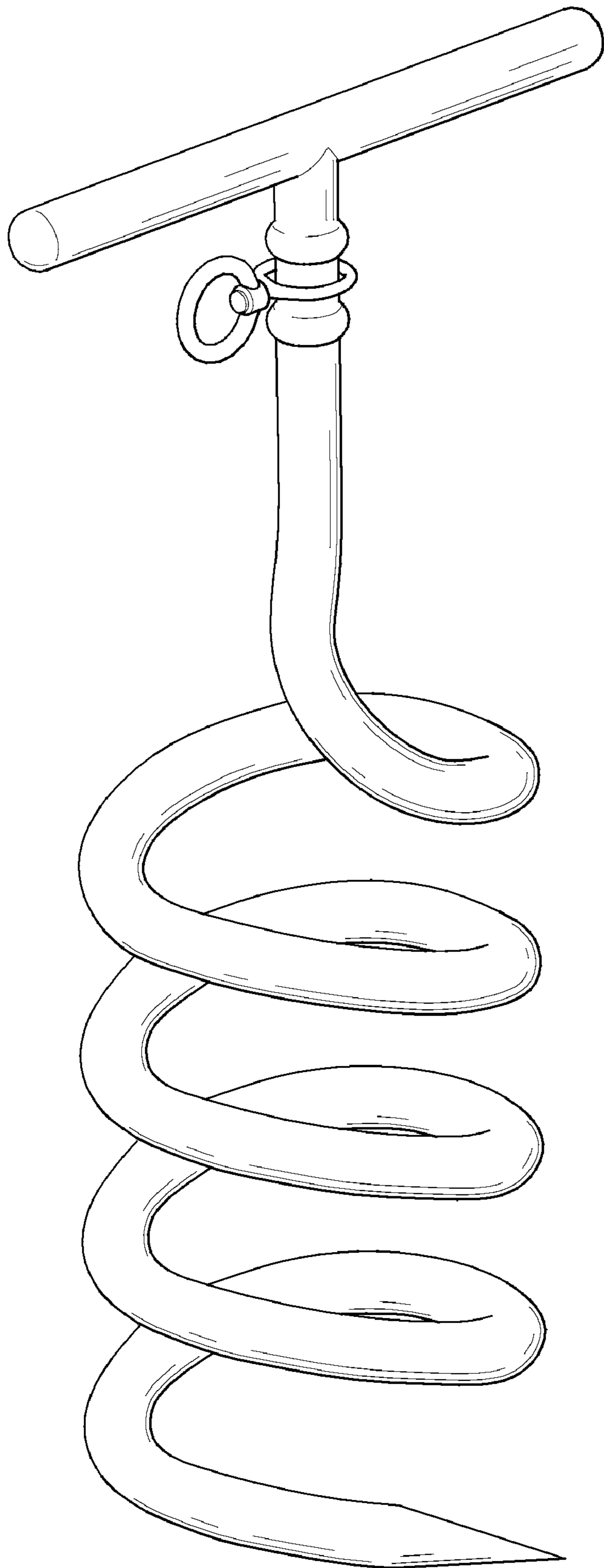
FIG. 5 is a bottom view thereof;

FIG. 6 is a left side view thereof; and,

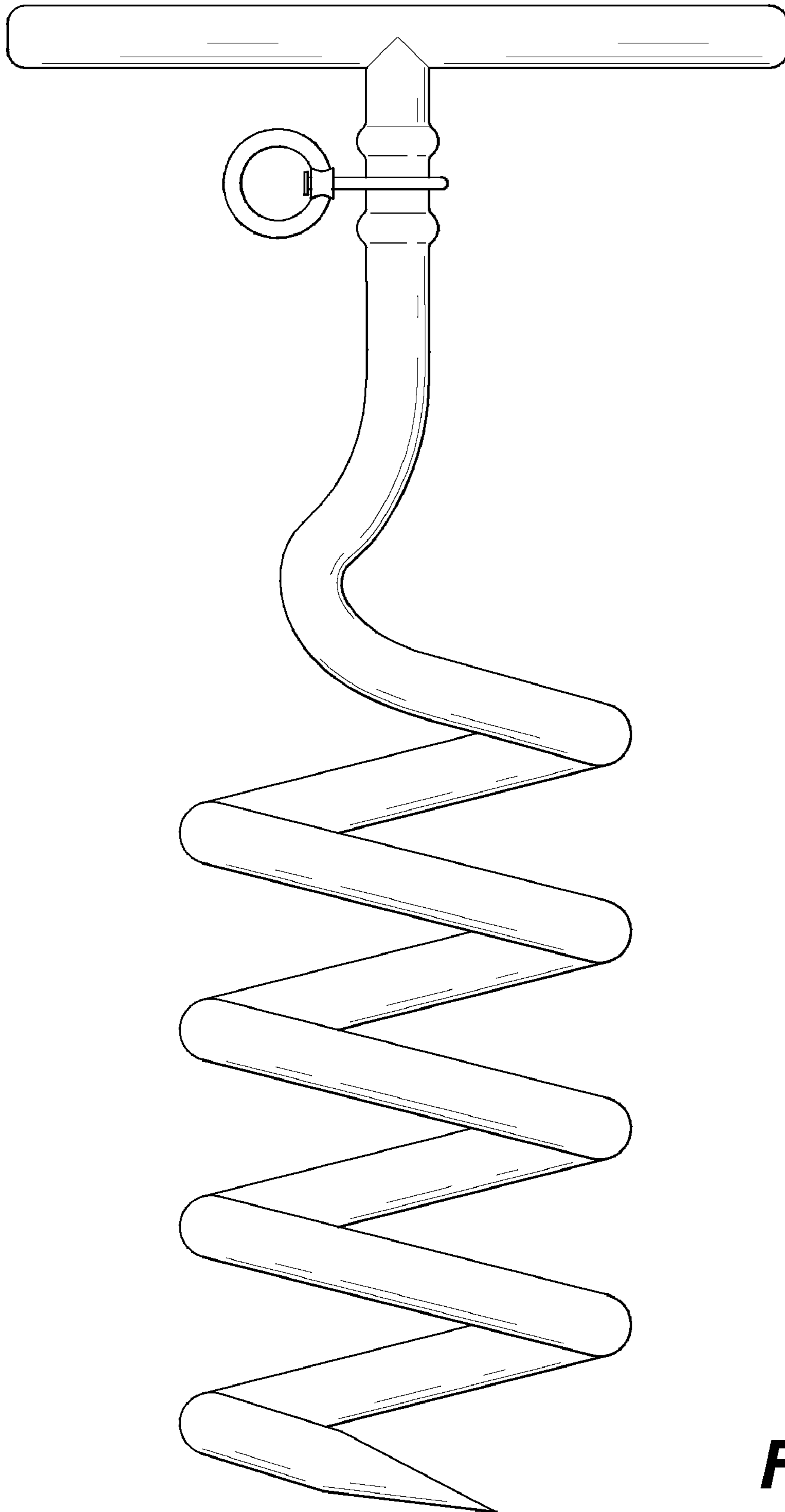
FIG. 7 is a right side view thereof.

**1 Claim, 6 Drawing Sheets**

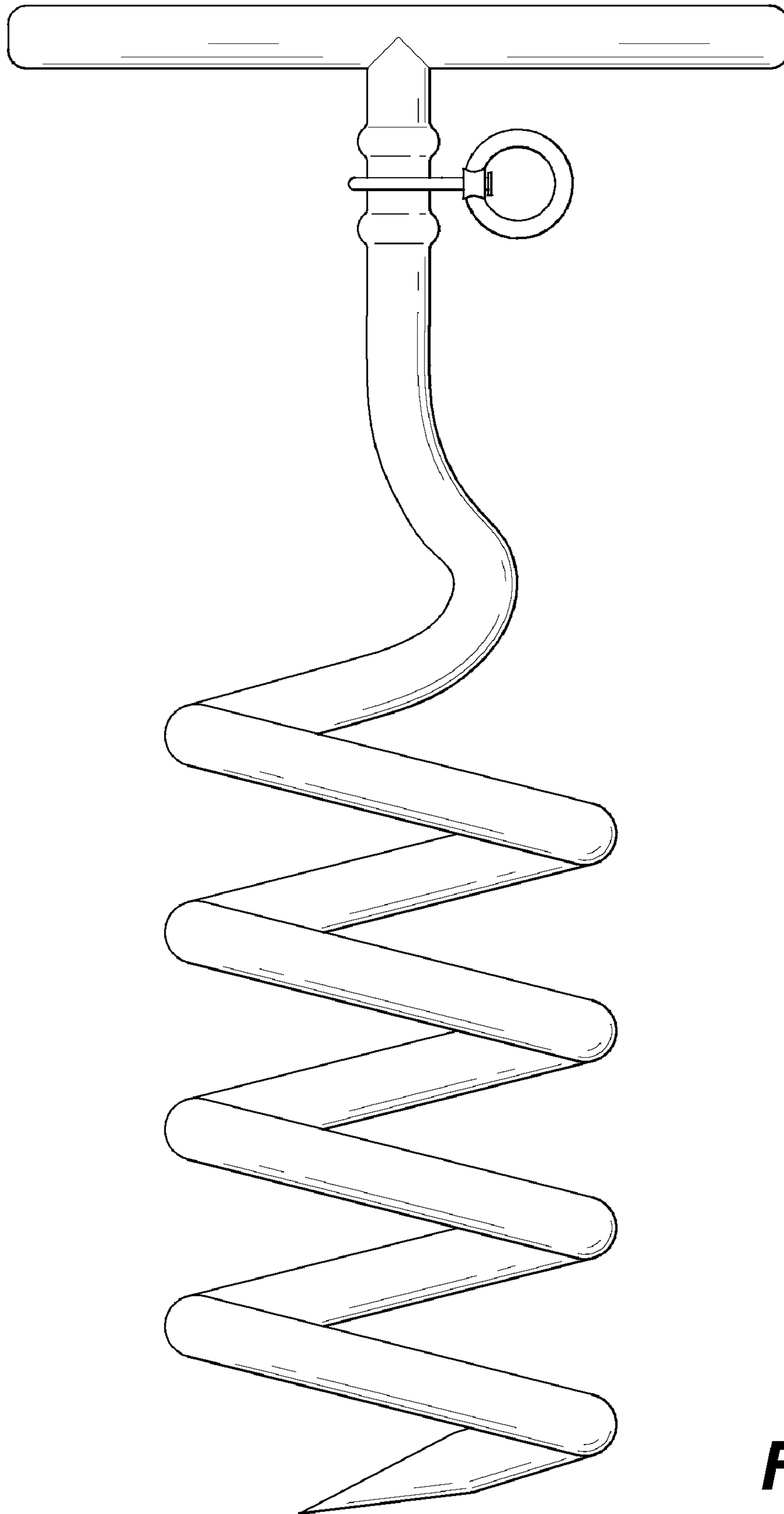




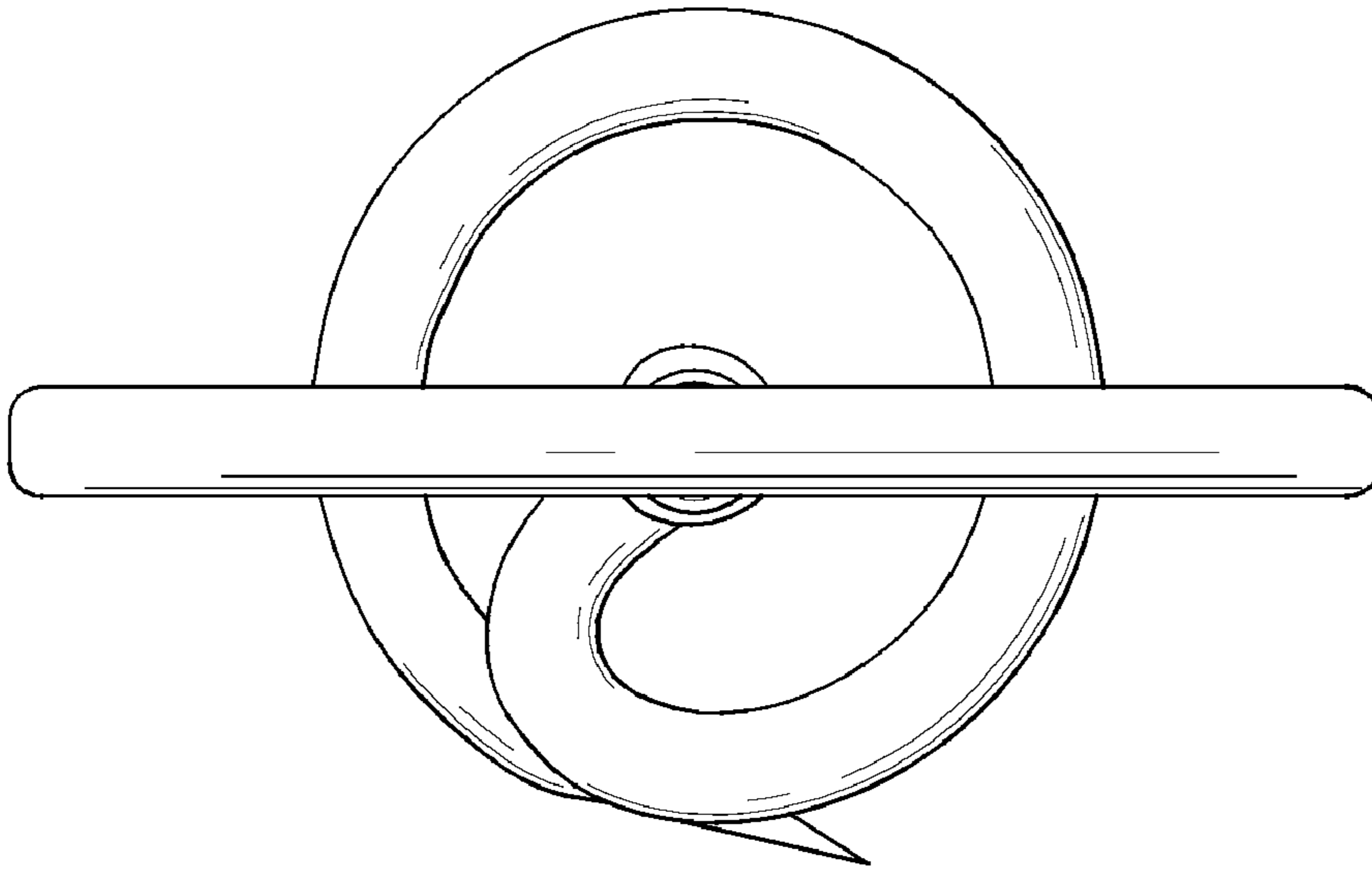
**Fig. 1**



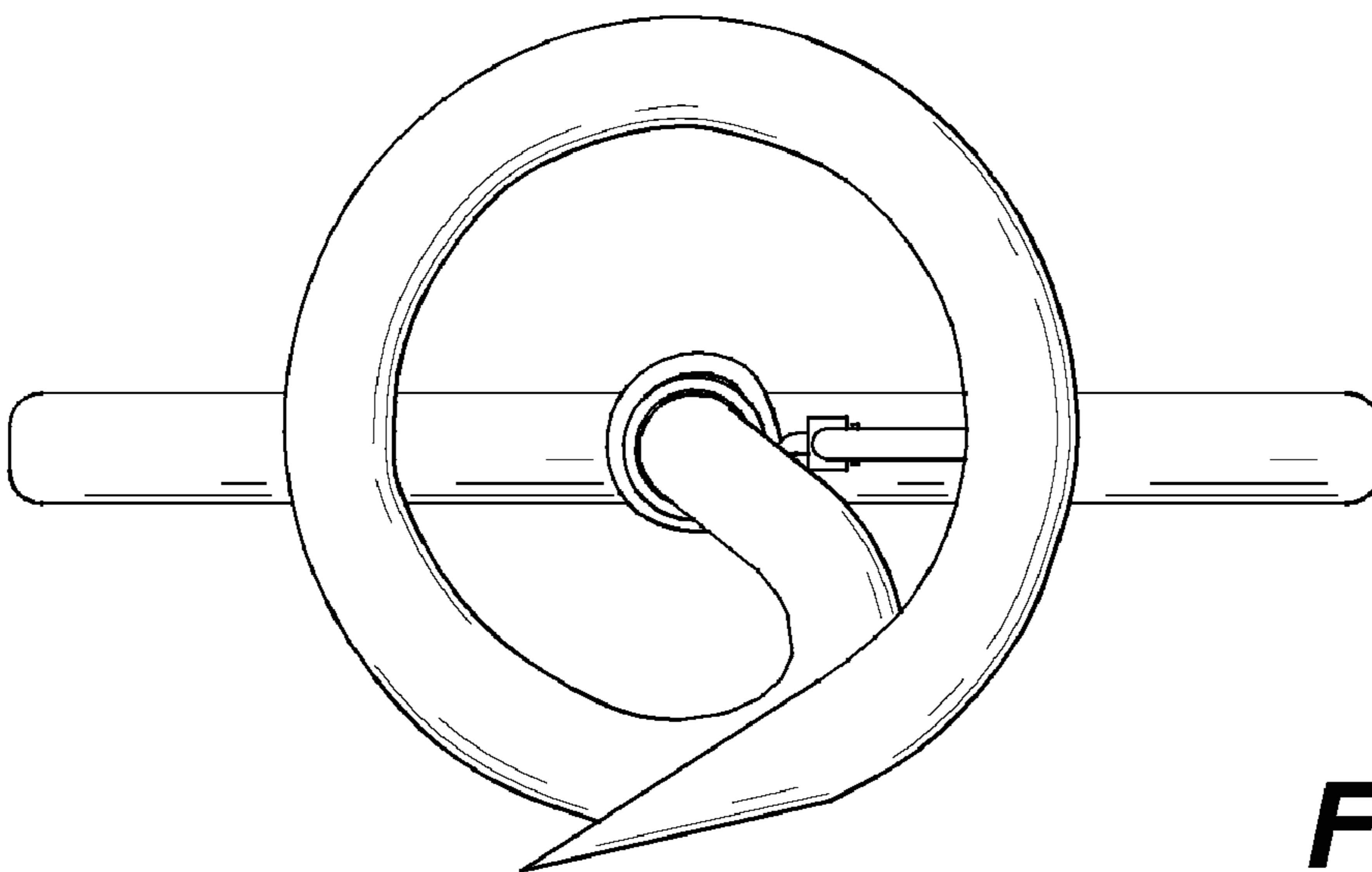
**Fig. 2**



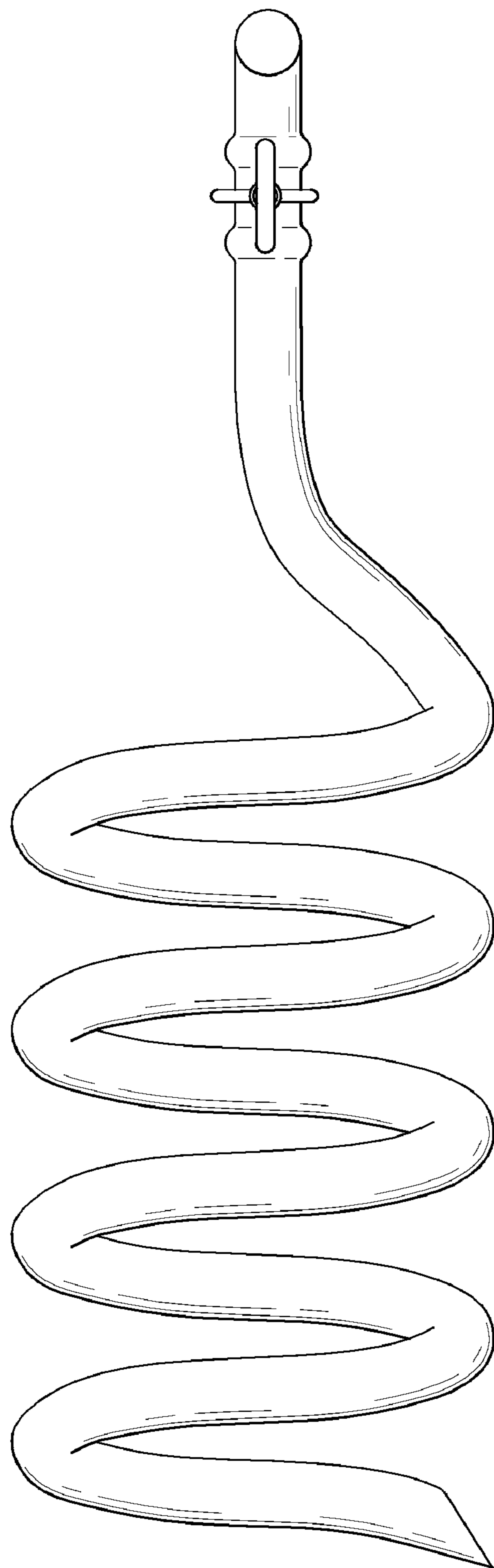
**Fig. 3**



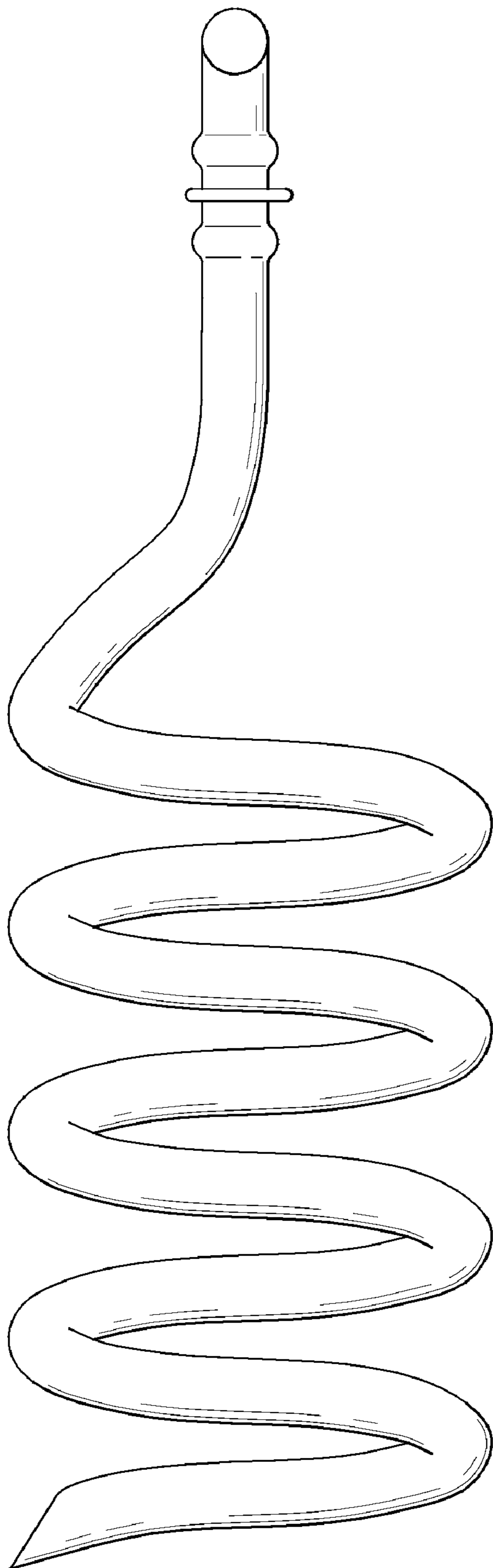
***Fig. 4***



***Fig. 5***



**Fig. 6**



**Fig. 7**