



US00D575711S

(12) **United States Design Patent**
Johannsen

(10) **Patent No.:** **US D575,711 S**

(45) **Date of Patent:** **** Aug. 26, 2008**

(54) **INPUT DEVICE FOR A VEHICLE CONTROL PANEL**

(75) Inventor: **Ulrike Johannsen**, Stuttgart (DE)

(73) Assignee: **Harman Becker Automotive Systems GmbH**, Karlsbad (DE)

(**) Term: **14 Years**

(21) Appl. No.: **29/249,020**

(22) Filed: **Sep. 15, 2006**

(30) **Foreign Application Priority Data**

Mar. 16, 2006 (EM) 000496971

(51) **LOC (8) Cl.** **12-16**

(52) **U.S. Cl.** **D12/192**

(58) **Field of Classification Search** D12/192;
D14/408, 417; 215/257, 328; 401/117; 72/348;
428/64; D9/449; D2/869; D18/40
See application file for complete search history.

(56) **References Cited**

U.S. PATENT DOCUMENTS

890,910	A *	6/1908	Kirkegaard	215/328
3,523,624	A *	8/1970	Curry	215/328
D434,038	S *	11/2000	Ho	D14/408
6,183,827	B1 *	2/2001	Folchini et al.	428/64.1
D441,011	S *	4/2001	Nozawa et al.	D18/40
D445,794	S *	7/2001	Johnston	D14/408
6,386,013	B1 *	5/2002	Werth	72/348
D462,506	S *	9/2002	Davison, III	D2/869
D477,532	S *	7/2003	Wong	D9/449
D525,517	S *	7/2006	Baldwin	D8/310
D553,621	S *	10/2007	Shimizu	D14/408
D555,651	S *	11/2007	Pascucci	D14/408
2004/0086319	A1 *	5/2004	Shamitoff	401/117
2005/0199576	A1 *	9/2005	Sanchez	215/328
2006/0188316	A1 *	8/2006	Shamitoff	401/117
2007/0181526	A1 *	8/2007	Frishman	215/257

* cited by examiner

Primary Examiner—Robert M. Spear

Assistant Examiner—George D Kirschbaum

(74) *Attorney, Agent, or Firm*—Plumsea Law Group, LLC

(57) **CLAIM**

The ornamental design for an input device for a vehicle control panel, as shown and described.

DESCRIPTION

FIG. 1 is a perspective view of an input device for a vehicle control panel showing my new design;

FIG. 2 is a top plan view thereof;

FIG. 3 is a bottom plan view thereof;

FIG. 4 is a front elevational view thereof;

FIG. 5 is a side elevational view of one side thereof;

FIG. 6 is a side elevational view of the opposite side thereof;

FIG. 7 is a rear elevational view thereof;

FIG. 8 is a perspective view identical to FIG. 1 but showing different illustrative elements;

FIG. 9 is a top plan view of the device of FIG. 8;

FIG. 10 is a bottom plan view of the device of FIG. 8;

FIG. 11 is a front elevational view of the device of FIG. 8;

FIG. 12 is a side elevational view of one side of the device of FIG. 8;

FIG. 13 is a side elevational view of the opposite side of the device of FIG. 8; and,

FIG. 14 is a rear elevational view of the device of FIG. 8.

The broken line showings of the arc-shaped area with delineated sections in FIGS. 1–2, 4–6; the circle in FIGS. 3 and 10; the lozenge-shaped and trapezoid elements in FIGS. 8–9, and 11–13 depict environmental subject matter only and form no part of the claimed design.

1 Claim, 6 Drawing Sheets

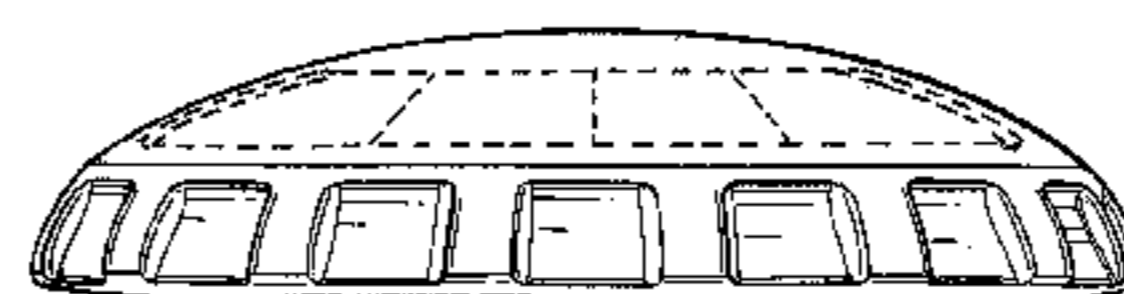
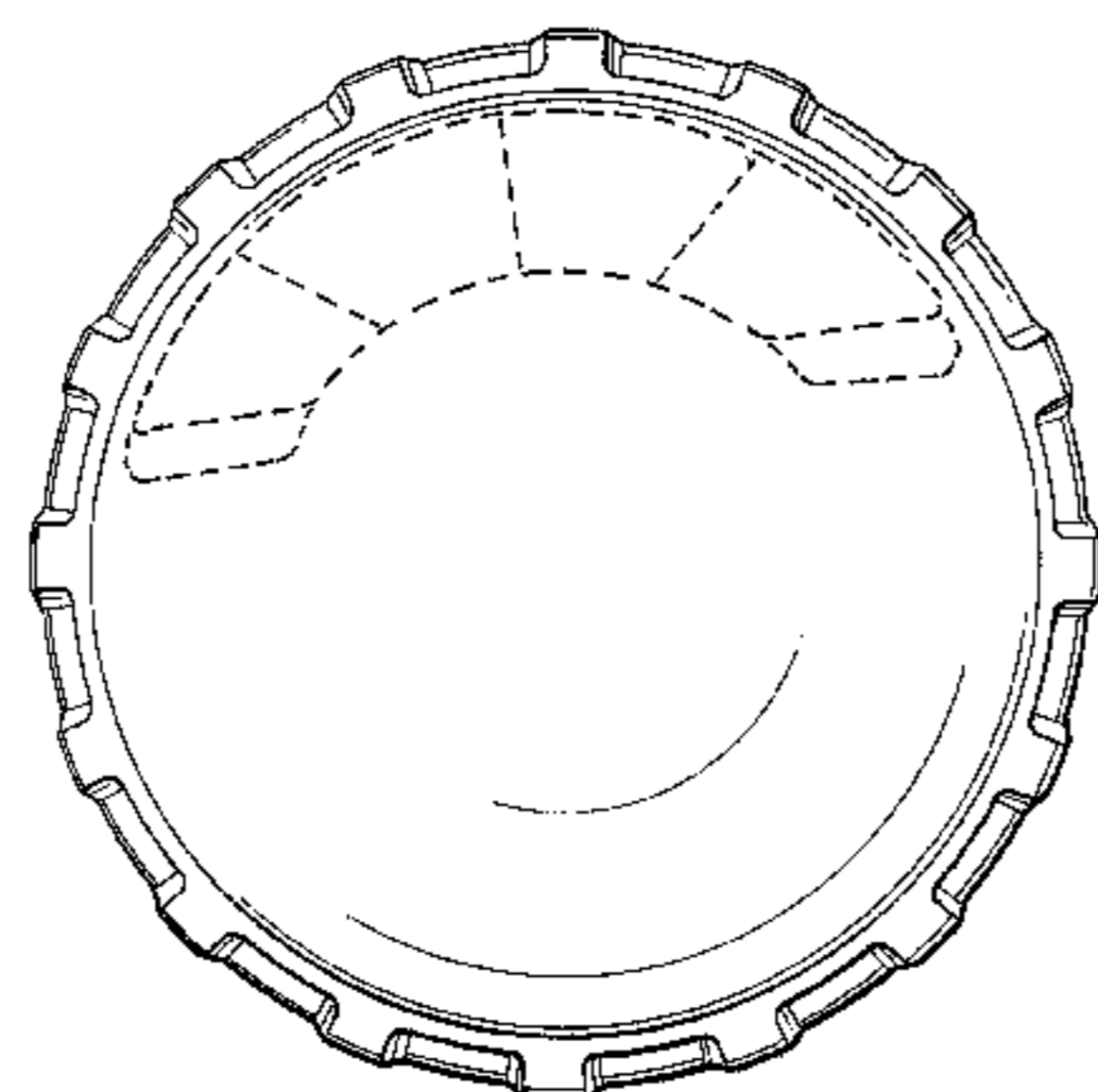
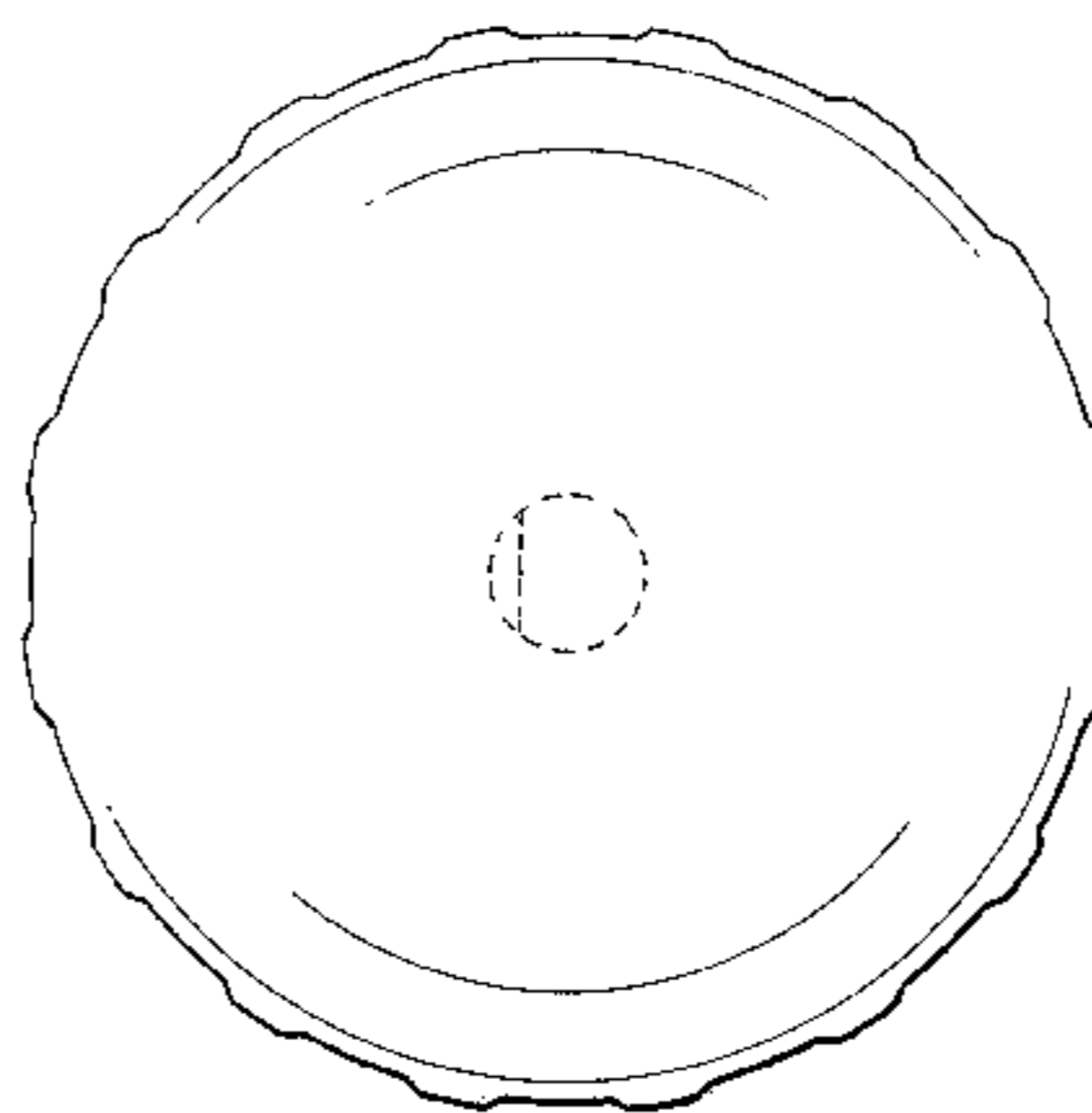
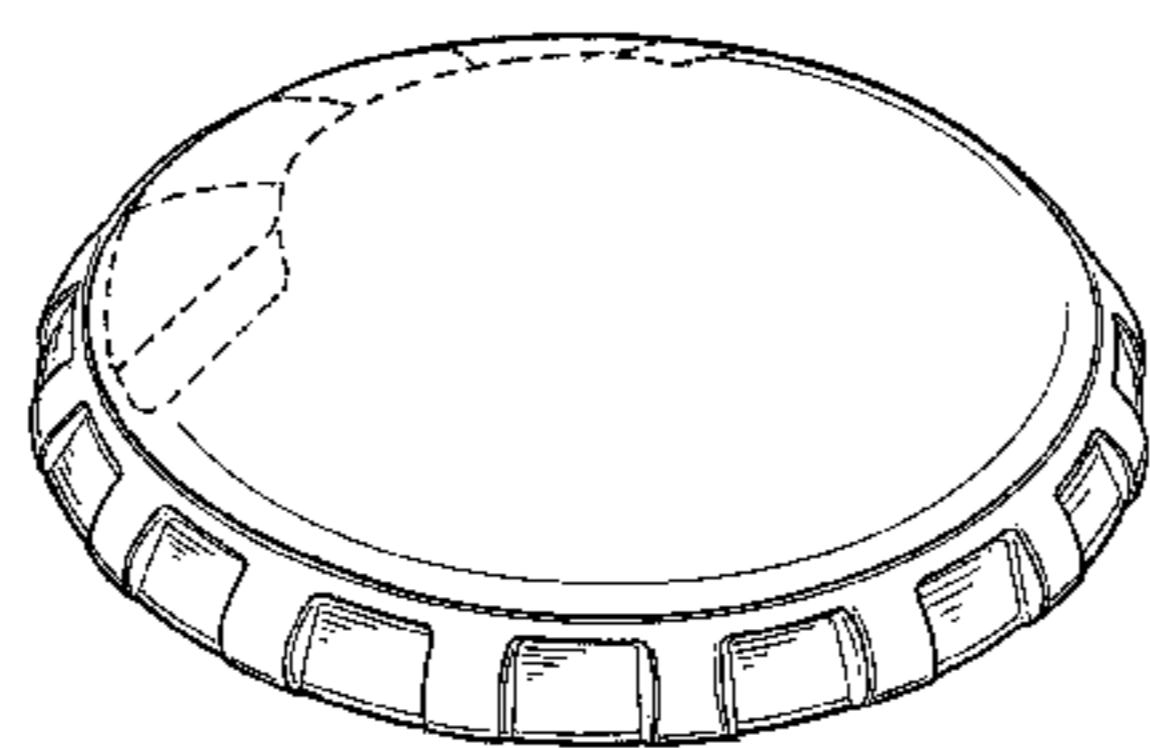

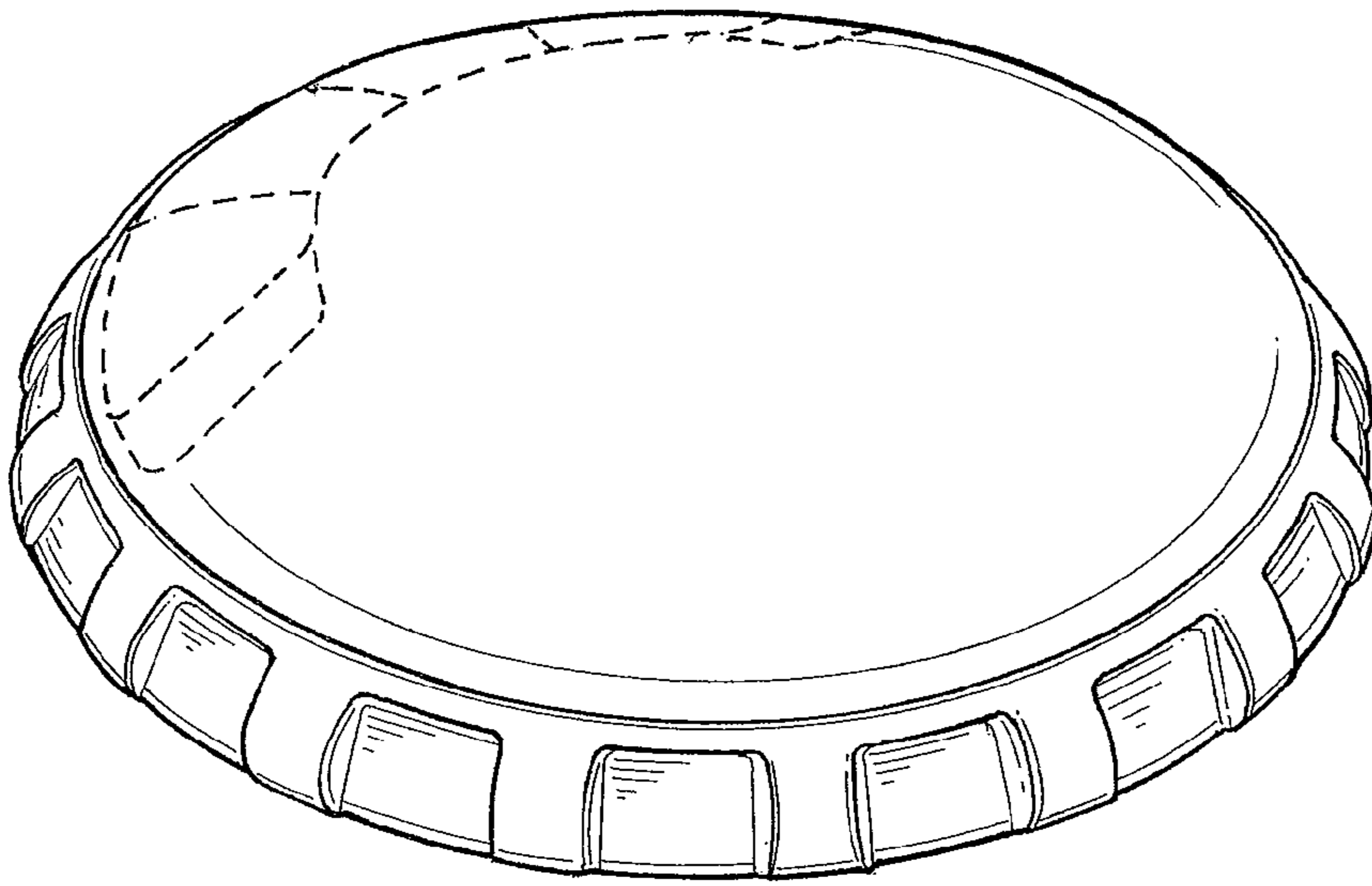

FIG. 1

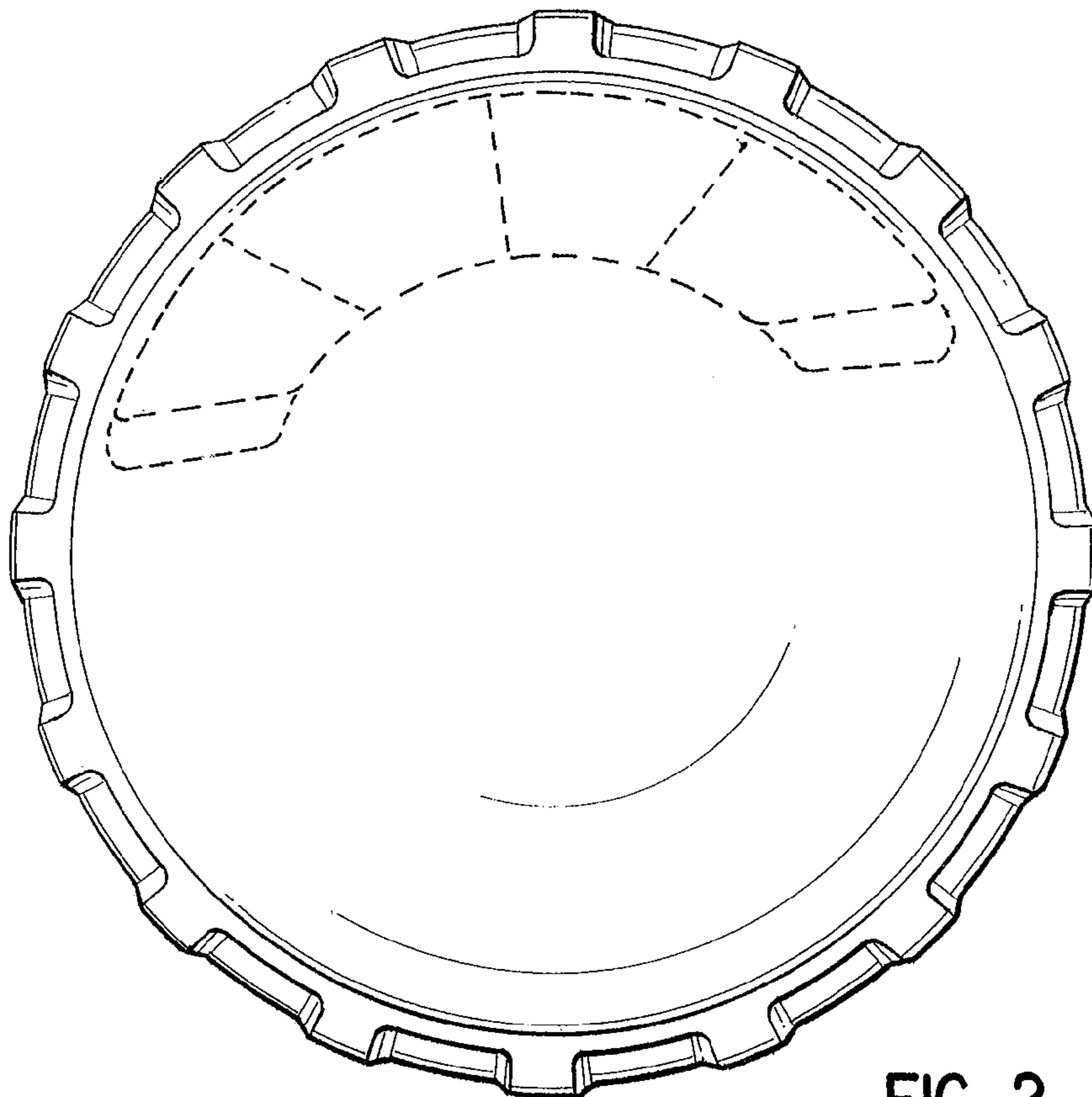

FIG. 2

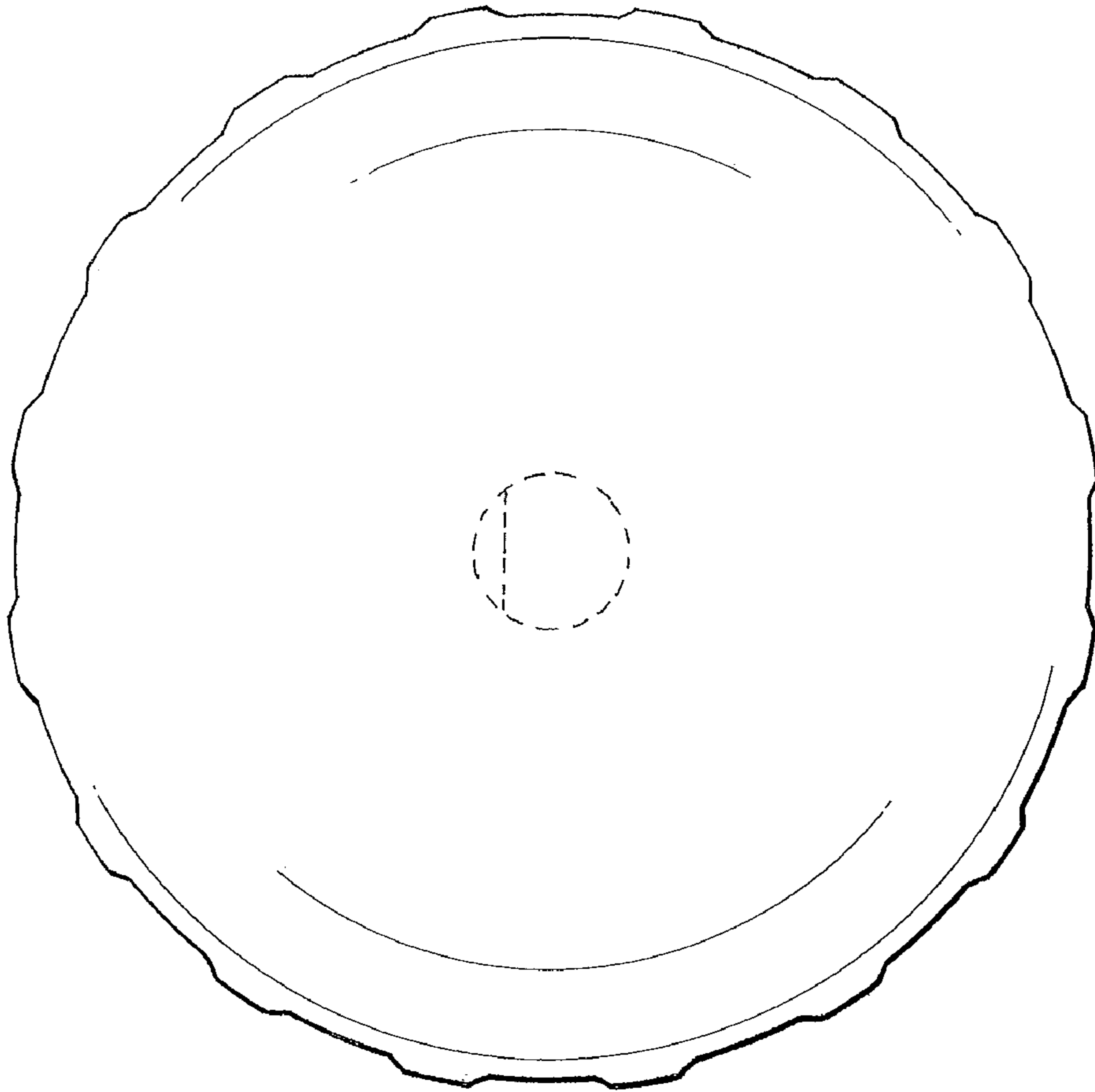

FIG. 3

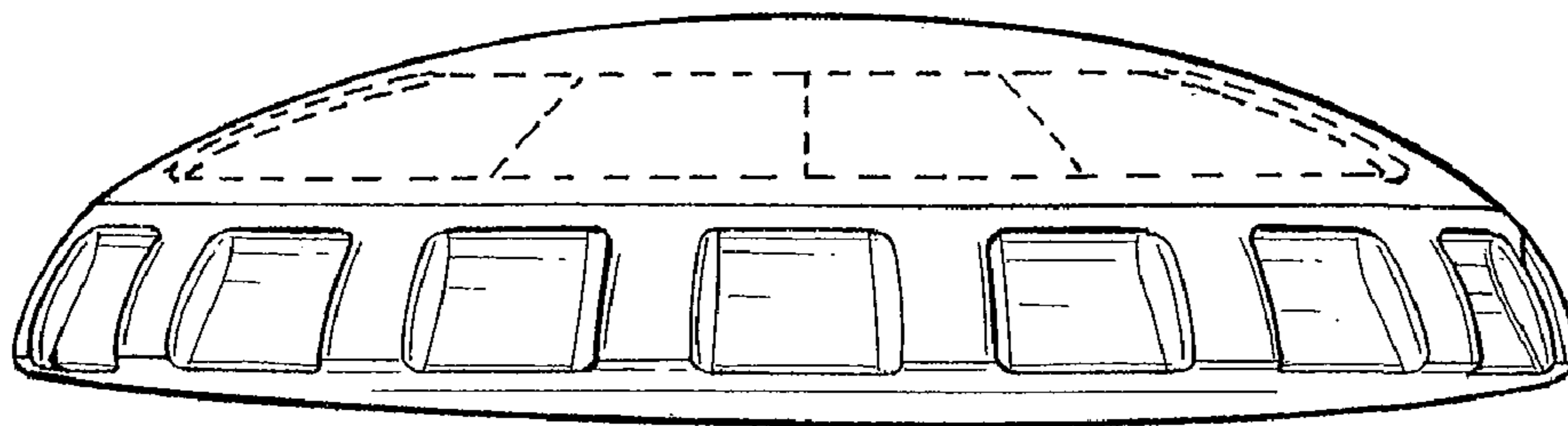

FIG. 4

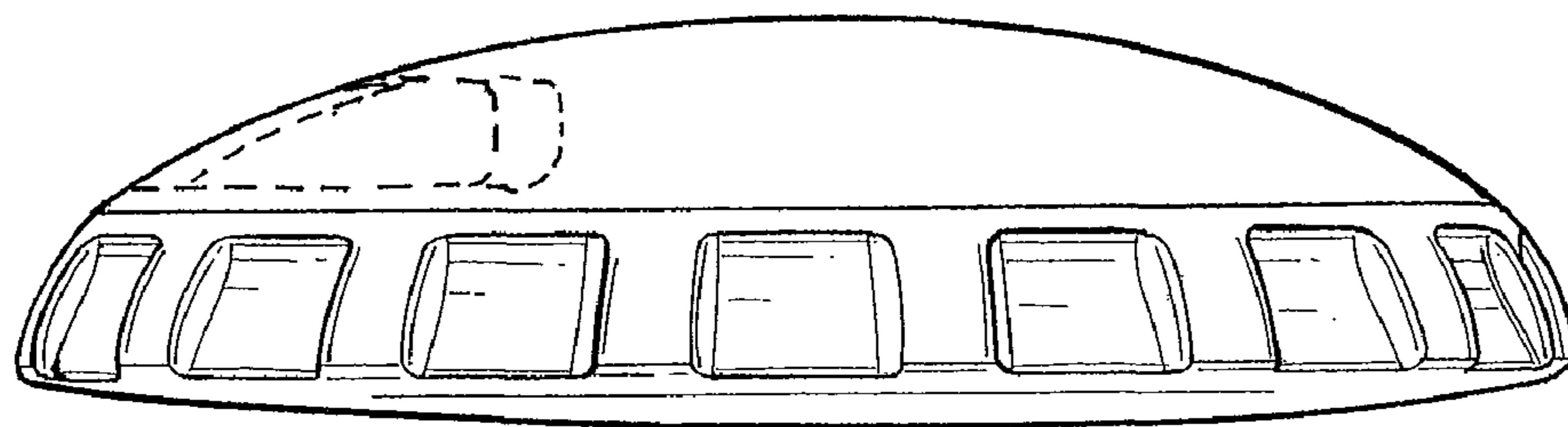

FIG. 5

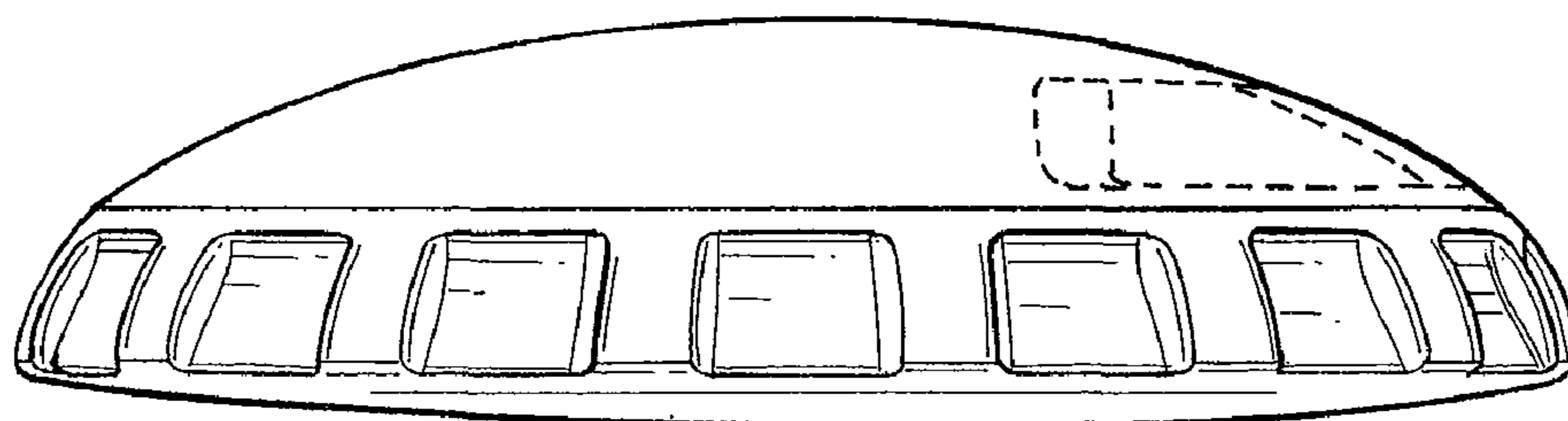

FIG. 6

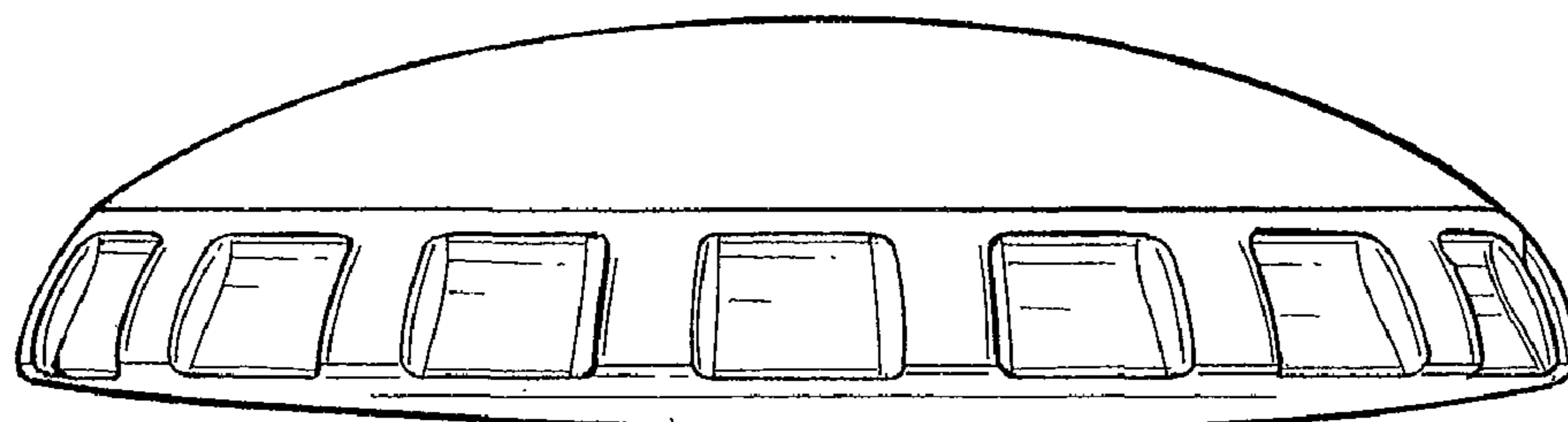

FIG. 7

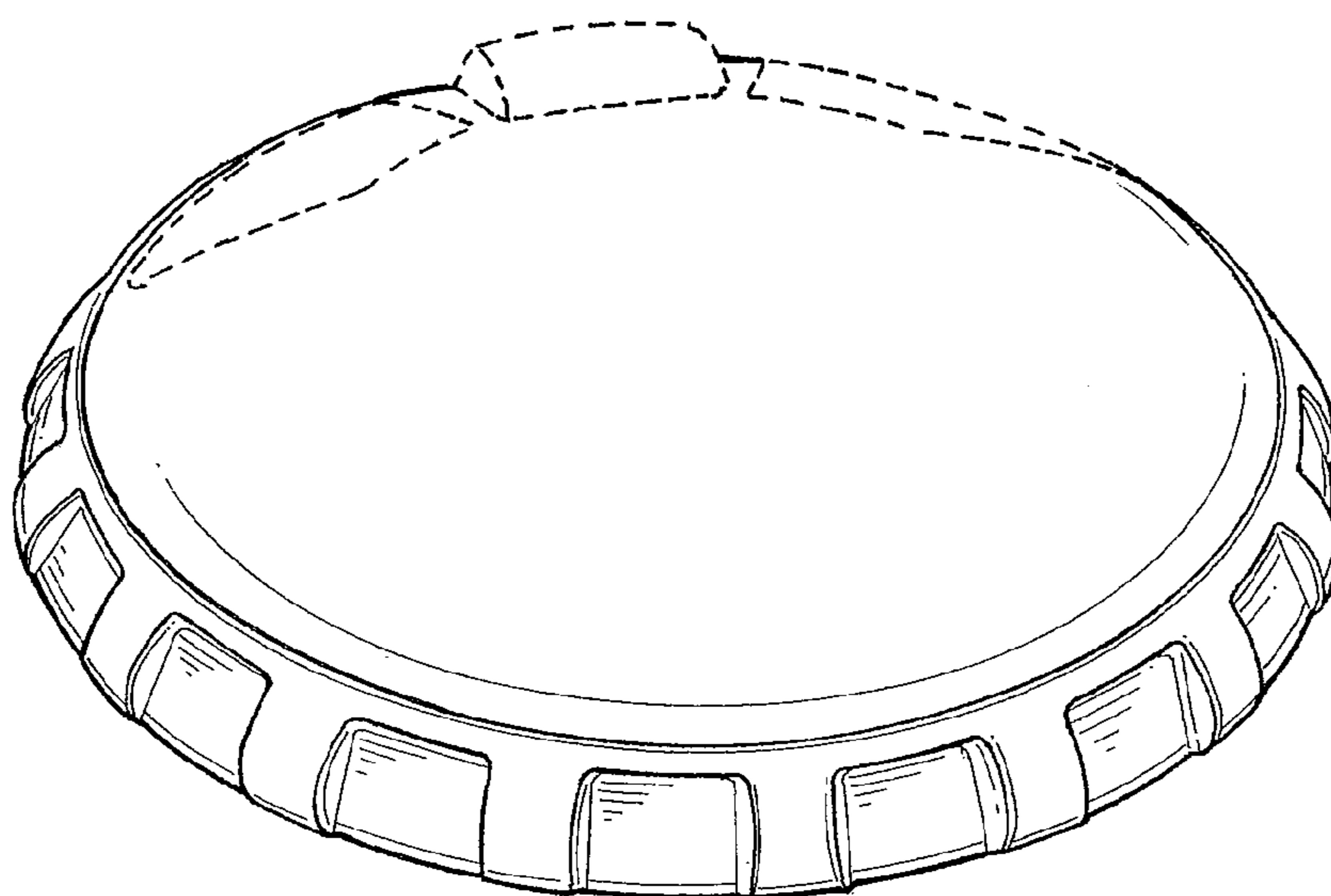

FIG. 8

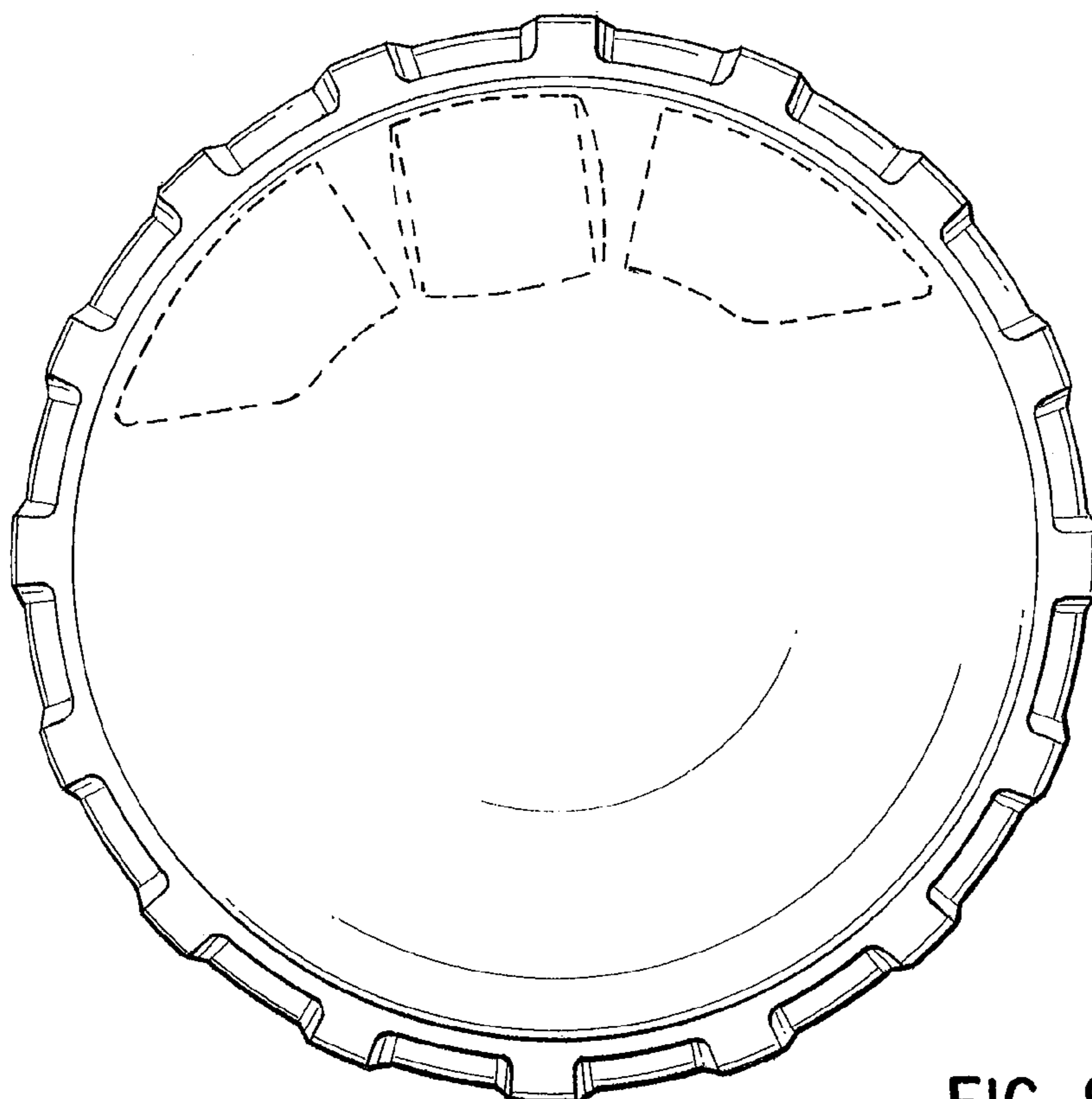

FIG. 9

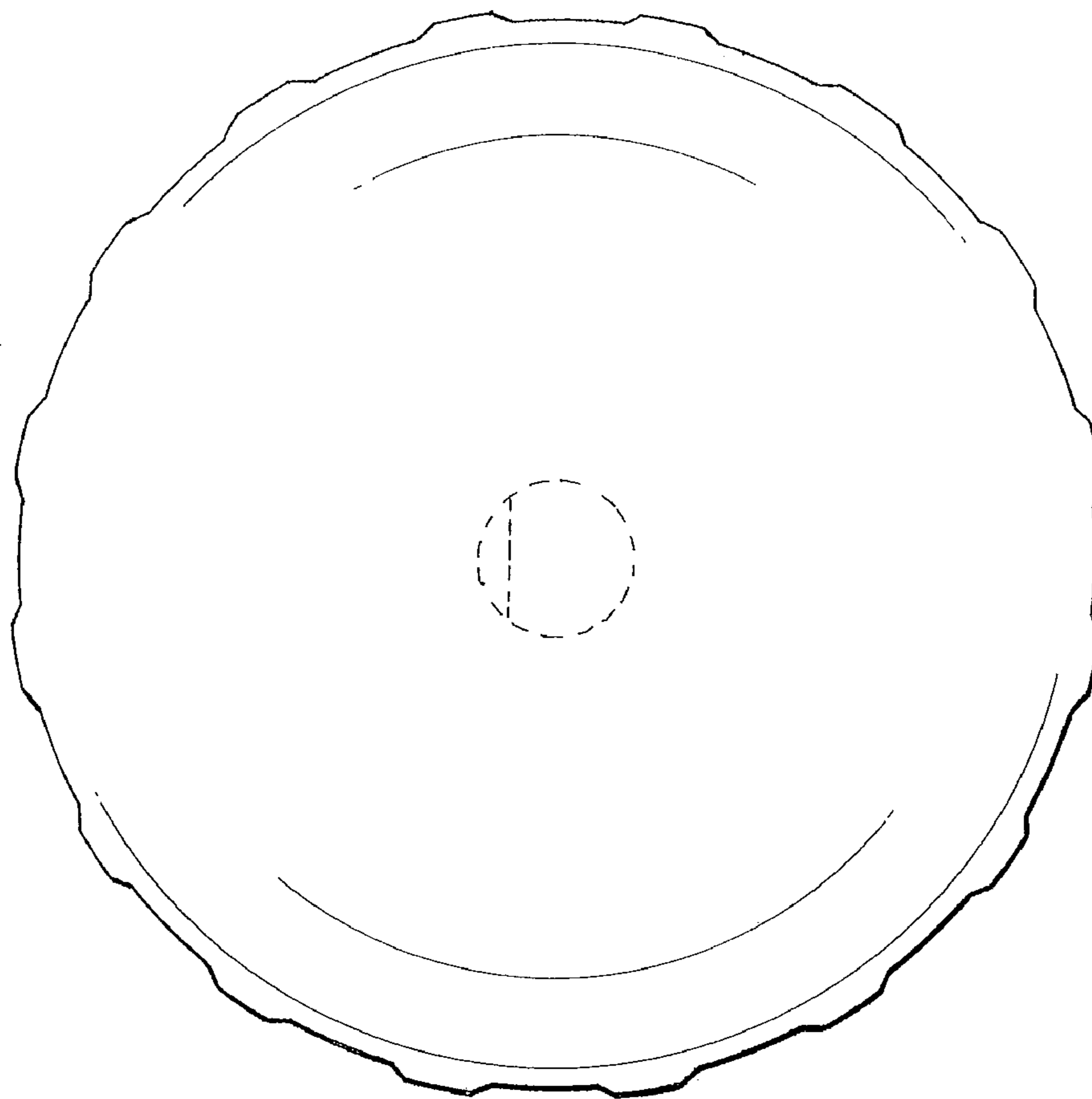

FIG. 10

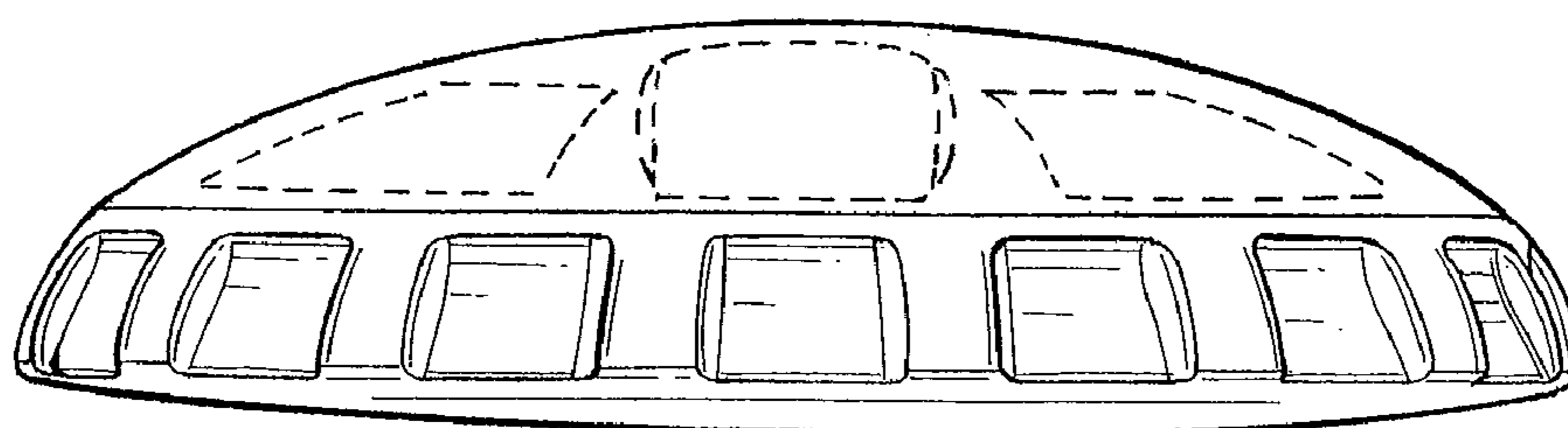

FIG. 11

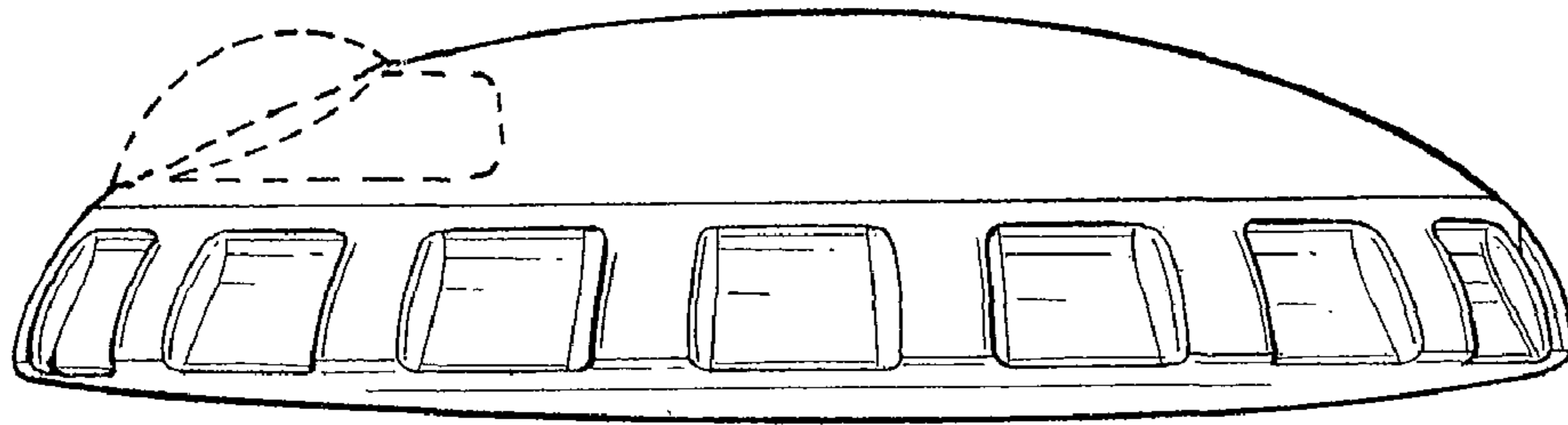

FIG. 12

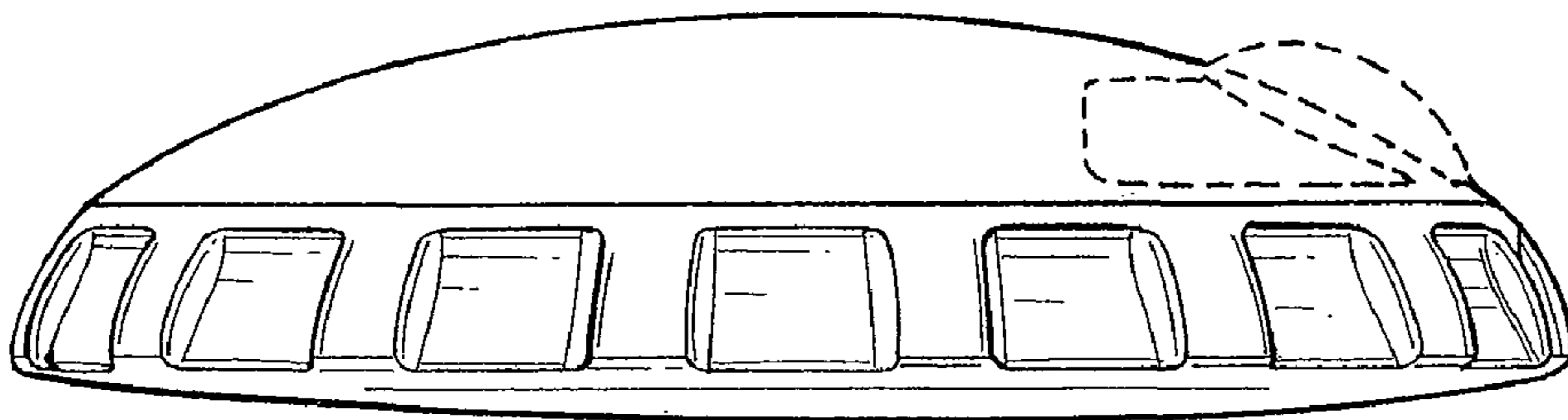

FIG. 13

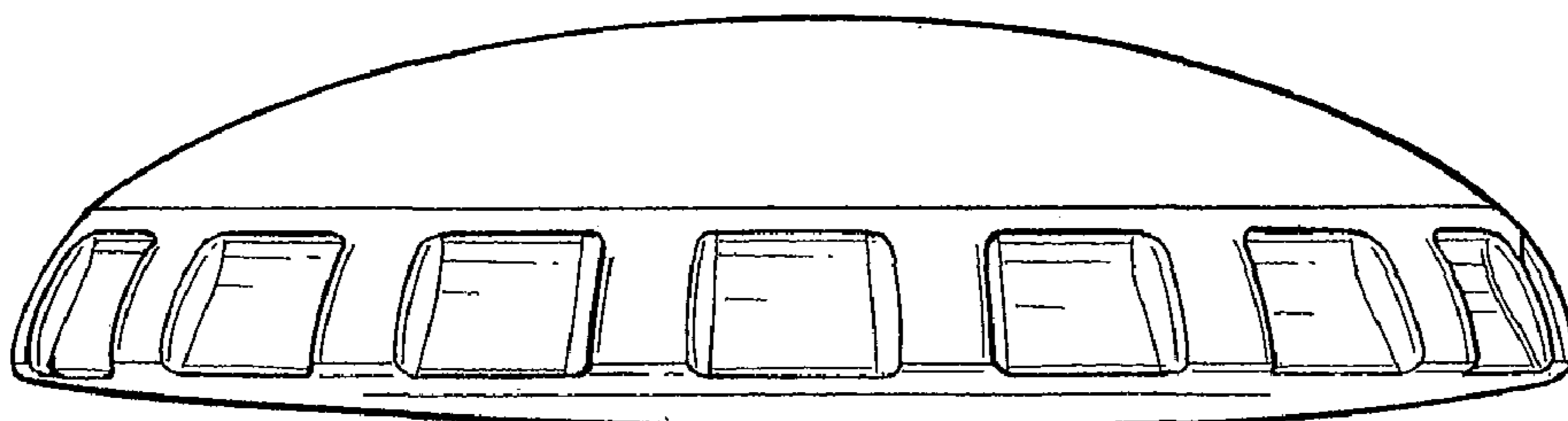

FIG. 14