



US00D575703S

(12) **United States Design Patent**
Jones

(10) **Patent No.:** **US D575,703 S**
(45) **Date of Patent:** **** Aug. 26, 2008**

- (54) **BICYCLE BRAKE**
 - (75) Inventor: **Christopher S. Jones**, Milwaukee, WI (US)
 - (73) Assignee: **Hayes Bicycle Group, Inc.**, Mequon, WI (US)
 - (**) Term: **14 Years**
 - (21) Appl. No.: **29/275,453**
 - (22) Filed: **Dec. 27, 2006**
 - (51) **LOC (8) Cl.** **12-16**
 - (52) **U.S. Cl.** **D12/180**
 - (58) **Field of Classification Search** D12/111, D12/179, 180; 188/73.1, 73.3, 73.31-73.39, 188/73.43, 73.45, 24.11-24.22, 344, 218 XL; 192/217, 217.1
- See application file for complete search history.

- 6,945,369 B1 9/2005 Chen
- D512,667 S 12/2005 Iwasaki
- D527,321 S * 8/2006 Gherardi et al. D12/180
- D548,656 S 8/2007 Hanamura
- 7,261,188 B2 8/2007 Kariyama
- 7,278,519 B2 10/2007 Iwai et al.

FOREIGN PATENT DOCUMENTS

TW 596059 6/2004

OTHER PUBLICATIONS

Taiwan Bicycles Guide Parts & Accessories 2005-2006, p. 473.

* cited by examiner

Primary Examiner—Cathron Brooks
Assistant Examiner—Linda Brooks
(74) *Attorney, Agent, or Firm*—Whyte Hirschboeck Dudek SC

(57) **CLAIM**

The ornamental design for a bicycle brake, as shown and described.

DESCRIPTION

FIG. 1 is a perspective view of the design;
FIG. 2 is a side elevational view of FIG. 1;
FIG. 3 is a side elevational view of the opposite side of FIG. 2, but rotated clockwise 180 degrees from the position shown in FIG. 2;
FIG. 4 is a top view of FIG. 1;
FIG. 5 is a bottom view of FIG. 1;
FIG. 6 is a front view of FIG. 1; and,
FIG. 7 is a rear view of FIG. 1.
The broken lines showing portions of the bicycle brake form no part of the claimed design.

(56) **References Cited**

U.S. PATENT DOCUMENTS

- D351,365 S * 10/1994 Powers D12/180
- D354,469 S * 1/1995 Powers D12/180
- 6,003,639 A 12/1999 Buckley et al.
- 6,119,818 A 9/2000 Krumbeck et al.
- 6,164,421 A 12/2000 Nakamura et al.
- D436,904 S 1/2001 Terasawa
- D437,274 S 2/2001 Terasawa
- D437,813 S 2/2001 Terasawa
- D439,872 S 4/2001 Terasawa
- D439,873 S 4/2001 Terasawa
- 6,340,074 B1 1/2002 Lumpkin et al.
- 6,394,236 B1 5/2002 Matsuishita
- 6,401,882 B1 6/2002 Ueda et al.
- 6,425,464 B2 7/2002 Lumpkin et al.
- 6,491,137 B2 12/2002 Lumpkin et al.
- 6,564,910 B1 5/2003 Chen et al.
- 6,761,251 B1 * 7/2004 Wen 188/26

1 Claim, 3 Drawing Sheets

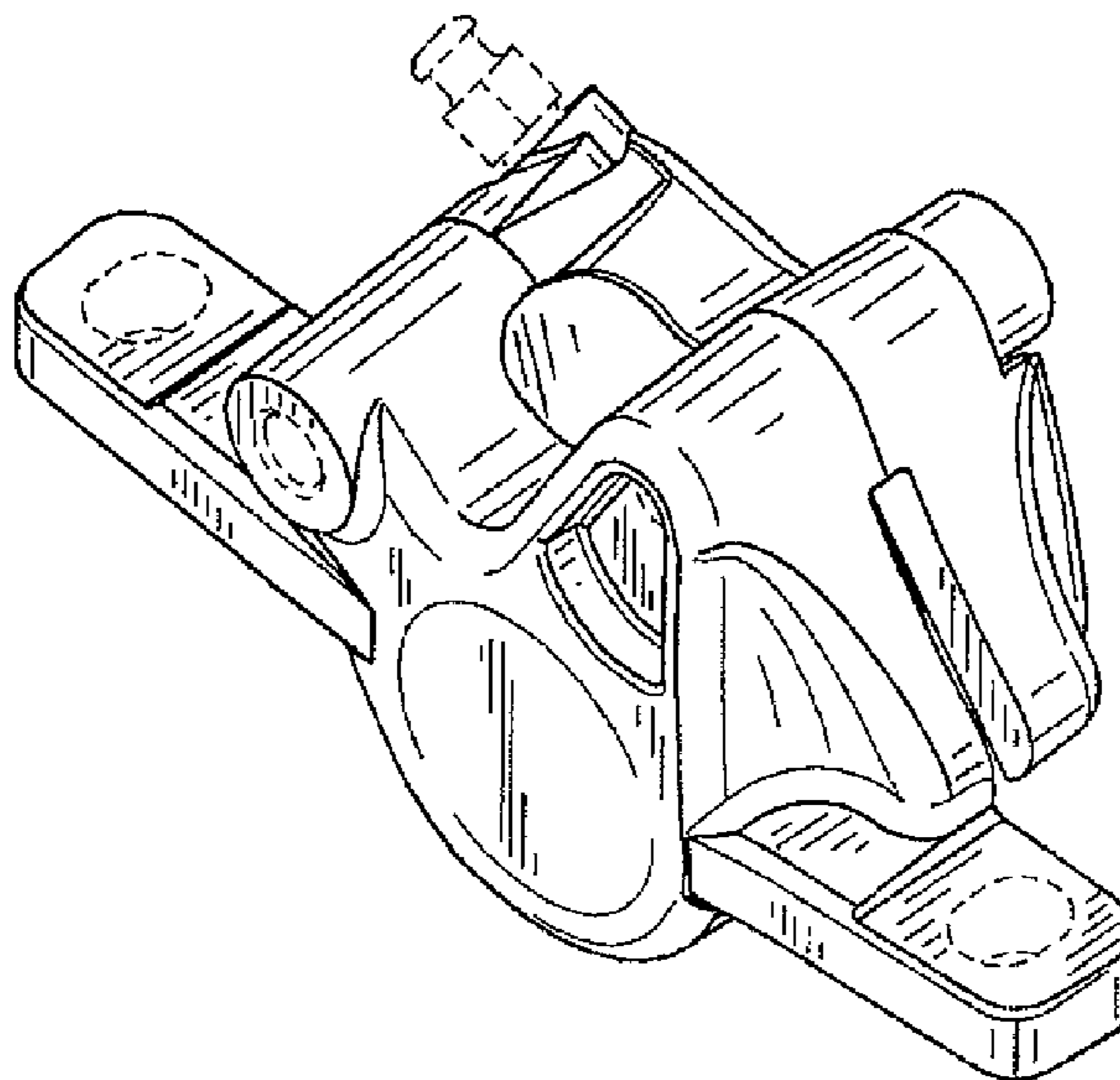

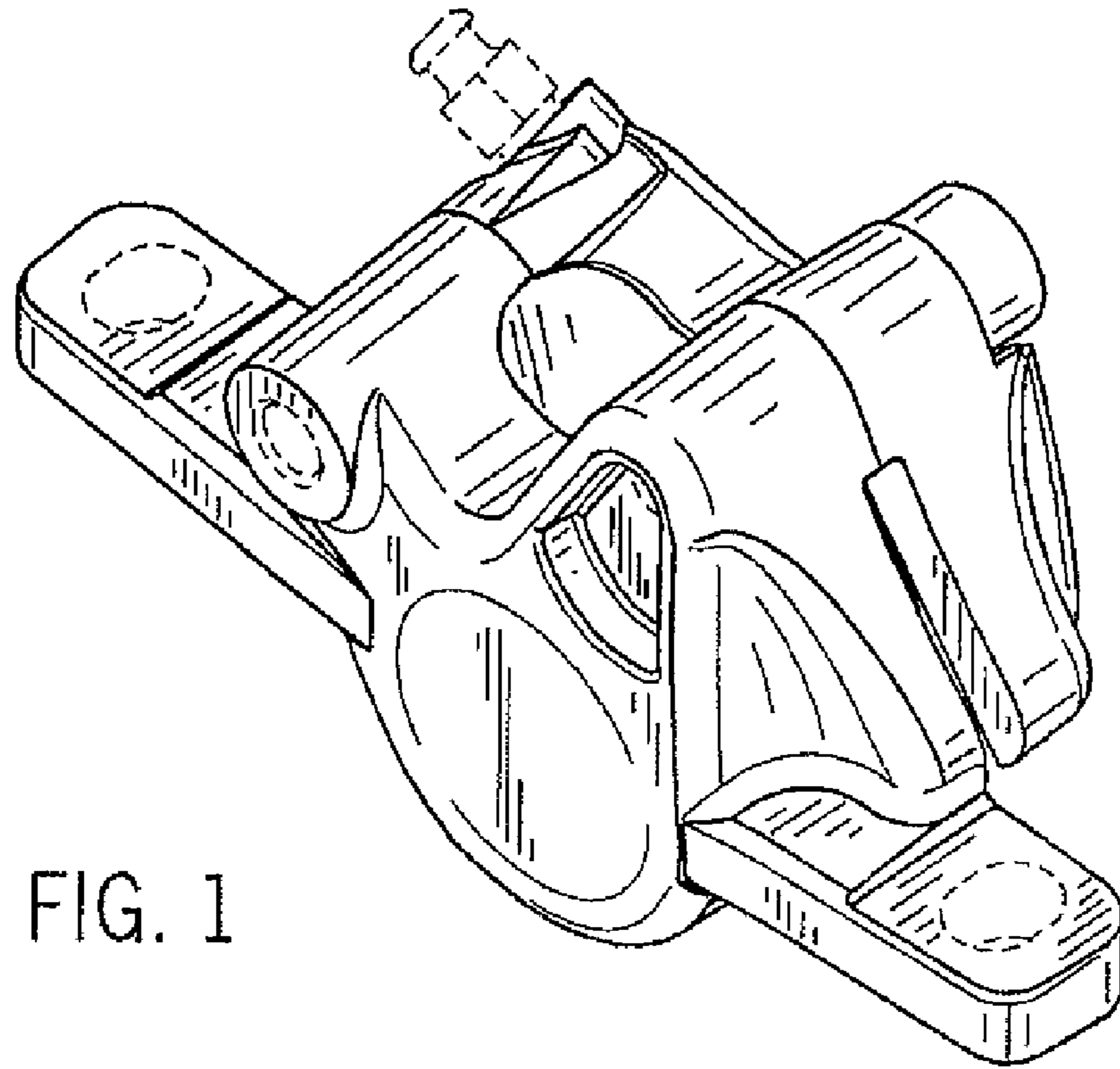

FIG. 1

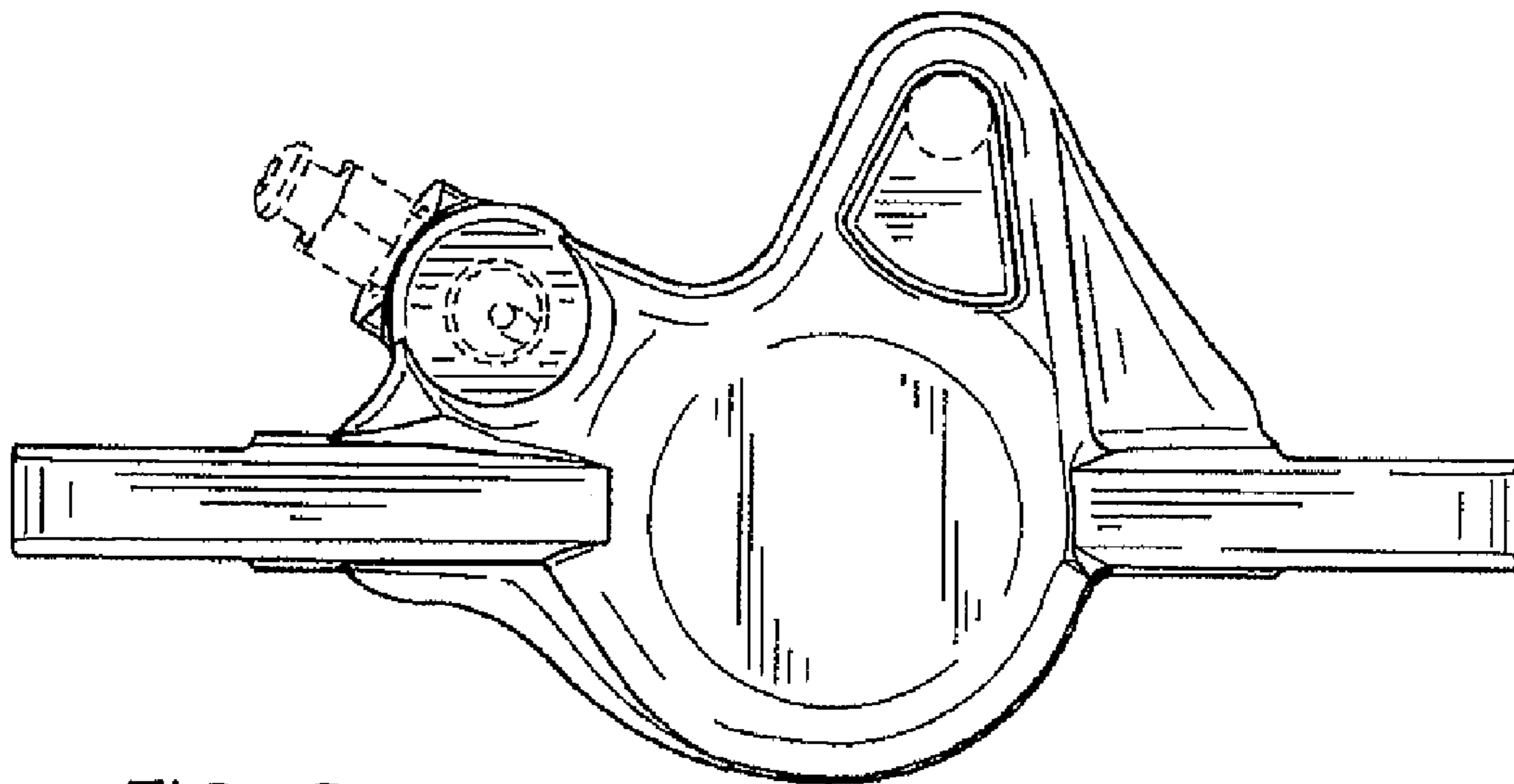

FIG. 2

FIG. 3

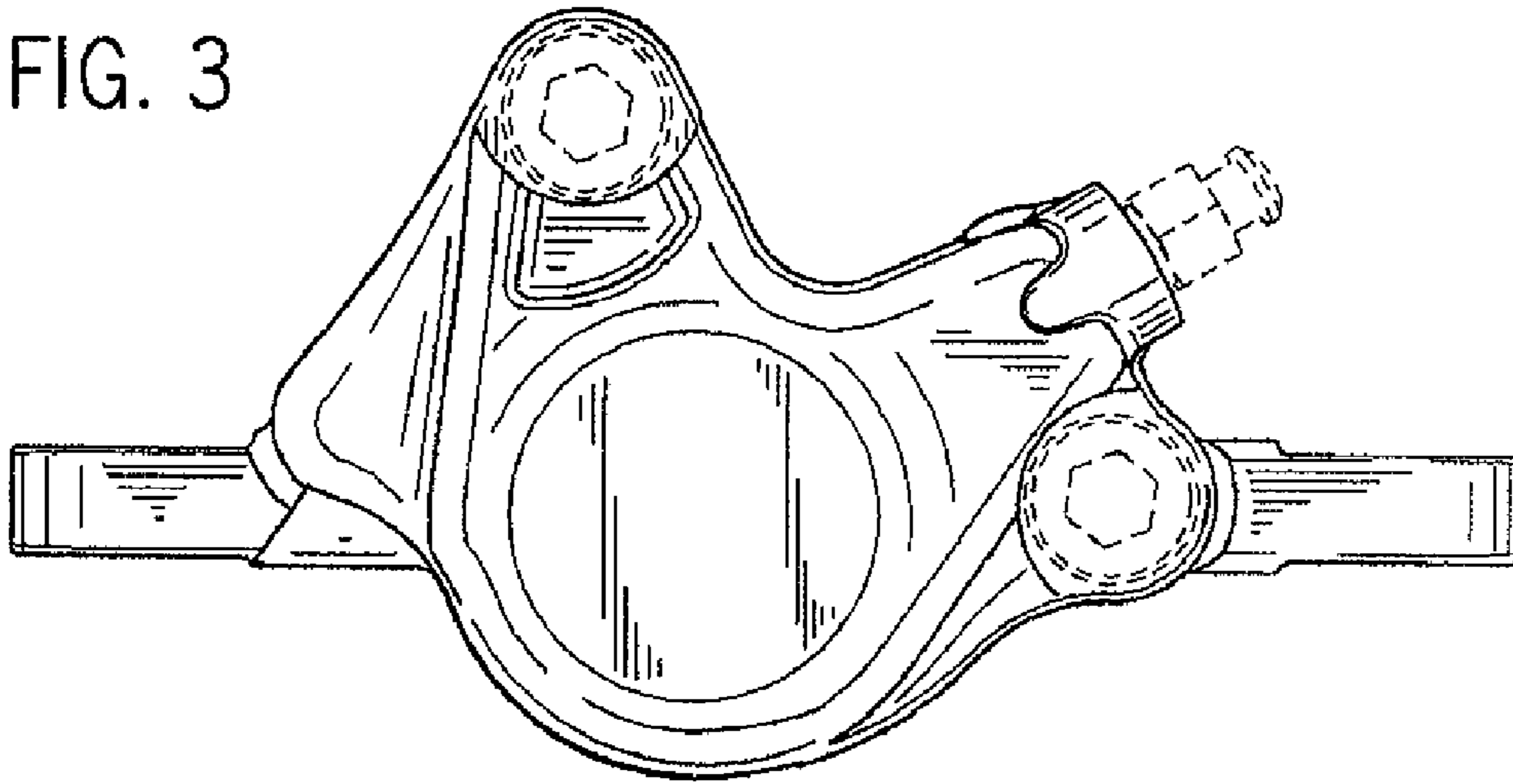

FIG. 4

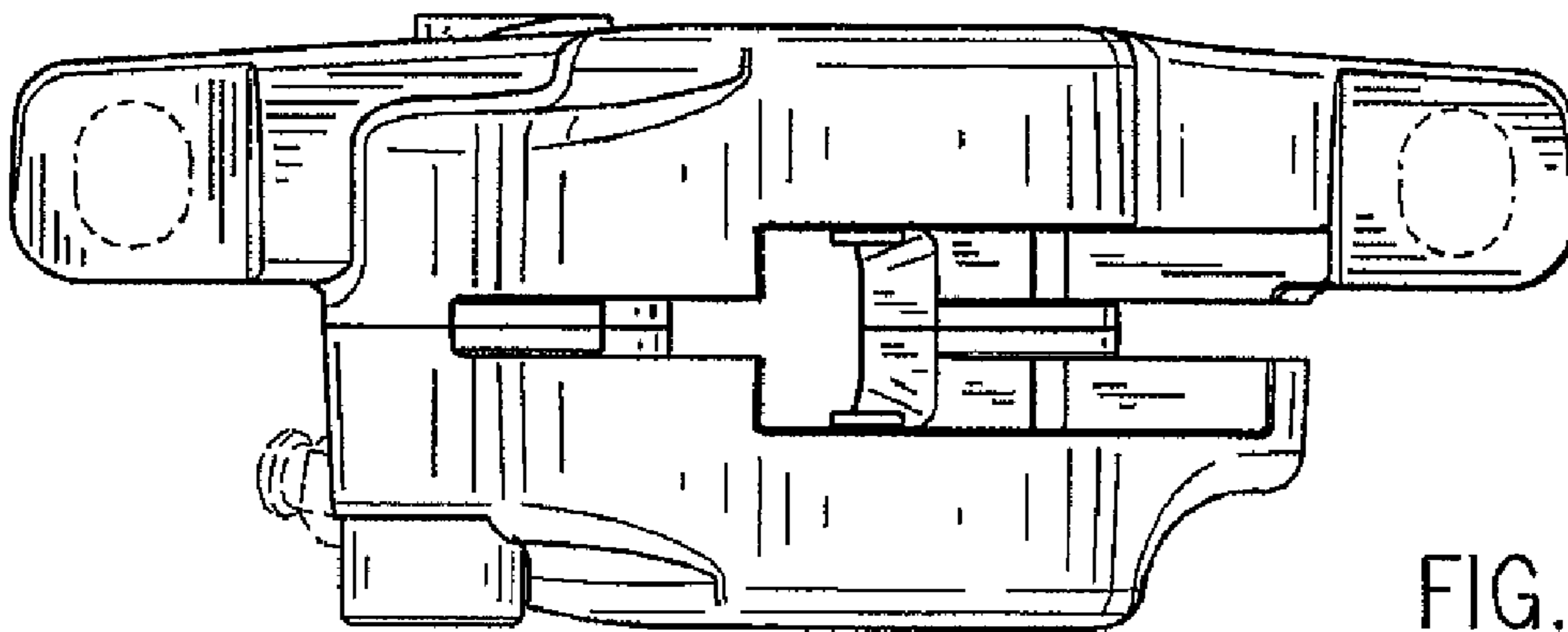
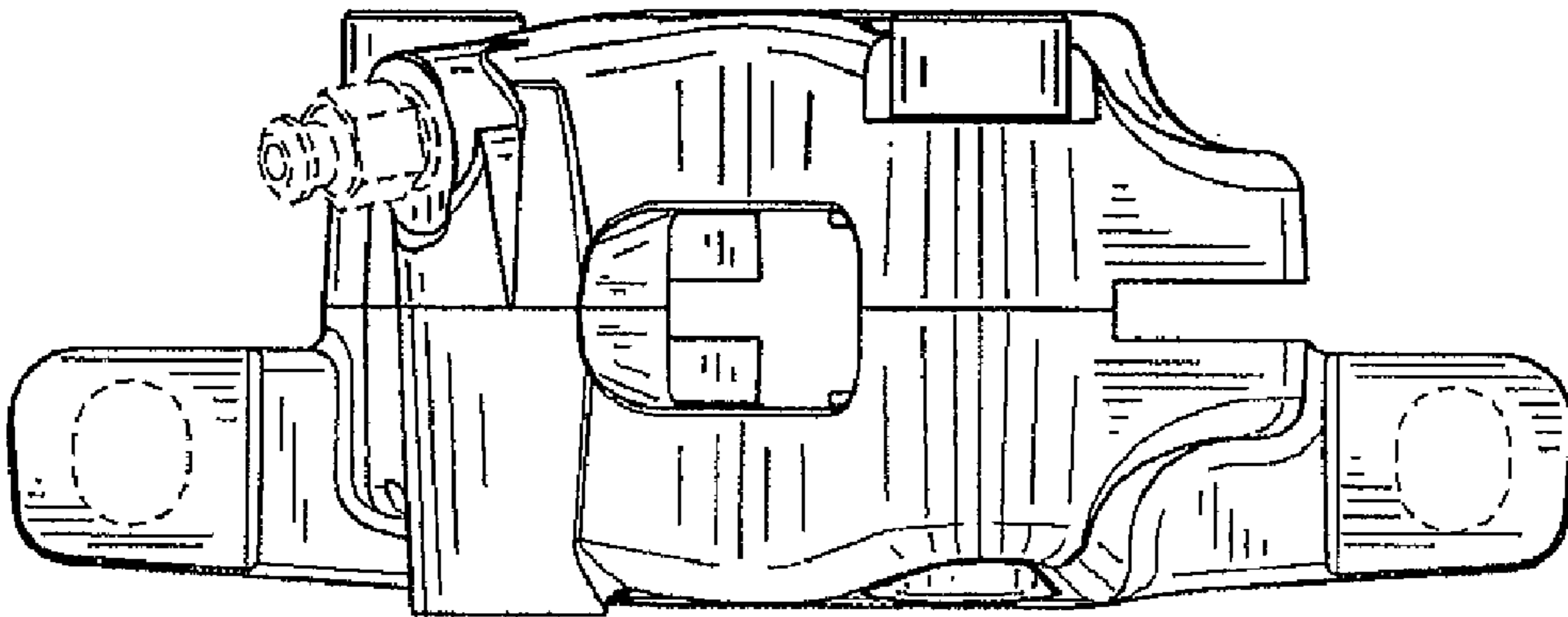

FIG. 5

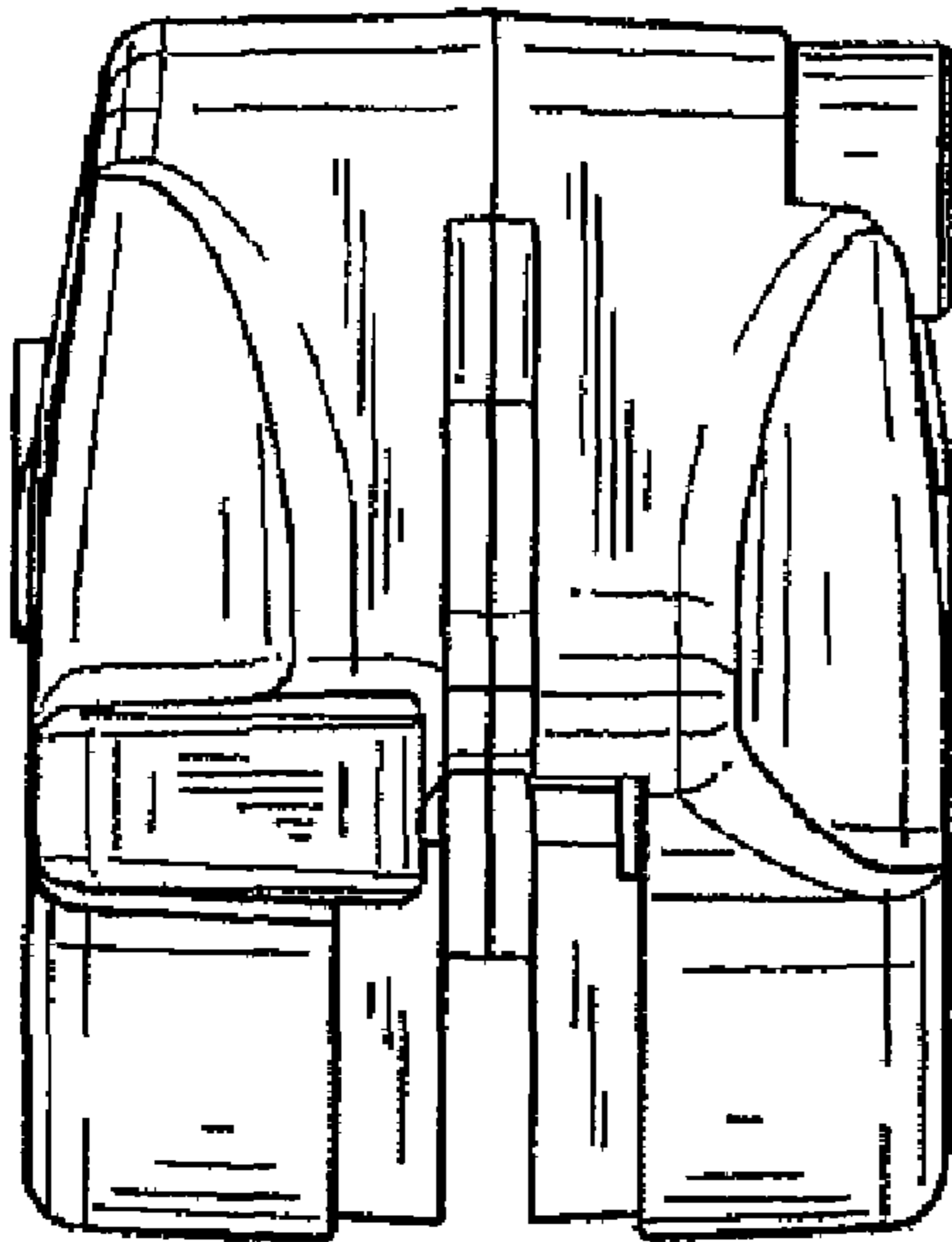

FIG. 6

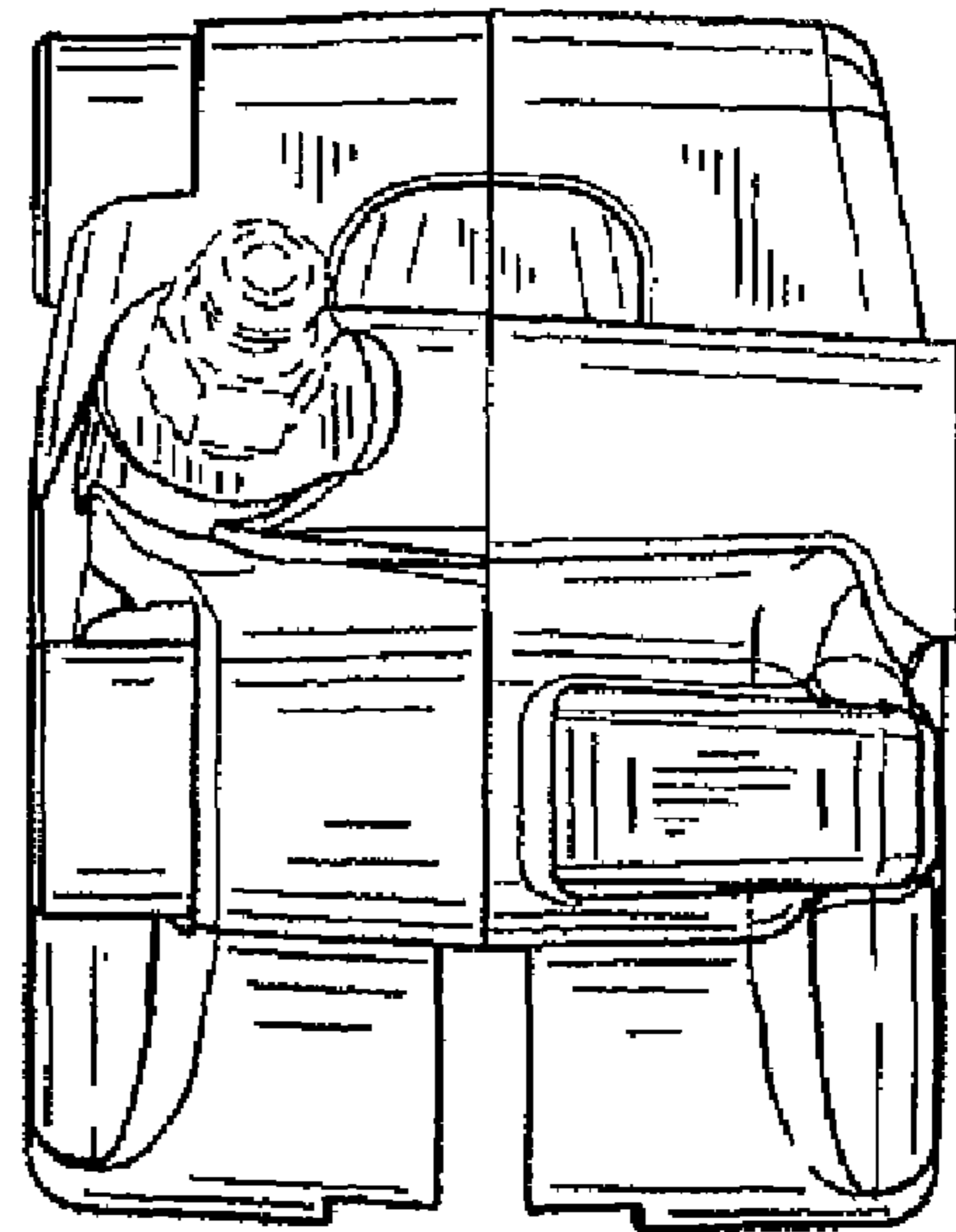

FIG. 7