

US00D575694S

(12) **United States Design Patent**  
**Opfer et al.**

(10) **Patent No.:** **US D575,694 S**

(45) **Date of Patent:** **\*\* Aug. 26, 2008**

(54) **VEHICLE FRONT BUMPER**

D553,049 S \* 10/2007 Opfer et al. .... D12/91  
D571,265 S \* 6/2008 Suzuki et al. .... D12/169

(75) Inventors: **John G Opfer**, Rochester, MI (US);  
**Timothy W Anness**, Rochester Hills, MI  
(US)

\* cited by examiner

*Primary Examiner*—Melody N Brown

(74) *Attorney, Agent, or Firm*—Ralph E. Smith

(73) Assignee: **Chrysler LLC**, Auburn Hills, MI (US)

(57) **CLAIM**

(\*\*) Term: **14 Years**

The ornamental design for a vehicle front bumper, as shown and described.

(21) Appl. No.: **29/296,187**

(22) Filed: **Oct. 16, 2007**

**DESCRIPTION**

**Related U.S. Application Data**

FIG. 1 is a front perspective view of a vehicle front bumper showing my new design;

(63) Continuation-in-part of application No. 29/249,266, filed on Sep. 29, 2006, now Pat. No. Des. 553,049.

FIG. 2 is a rear perspective view thereof;

(51) **LOC (8) Cl.** ..... **12-16**

FIG. 3 is a front view thereof;

(52) **U.S. Cl.** ..... **D12/169**

FIG. 4 is a rear view thereof;

(58) **Field of Classification Search** ..... D12/169,  
D12/196, 171, 163, 216, 90-92, 86; 293/102,  
293/113, 115, 117, 120; 296/180.1, 180.2

FIG. 5 is a top plan view thereof;

See application file for complete search history.

FIG. 6 is a bottom plan view thereof; and,

FIG. 7 is a side view thereof, the opposite side view being a mirror image thereof.

(56) **References Cited**

It will be understood that the broken lines presented in the drawings are for illustration only, and do not form a part of the claimed design.

**U.S. PATENT DOCUMENTS**

D463,334 S \* 9/2002 Koman ..... D12/169

**1 Claim, 7 Drawing Sheets**

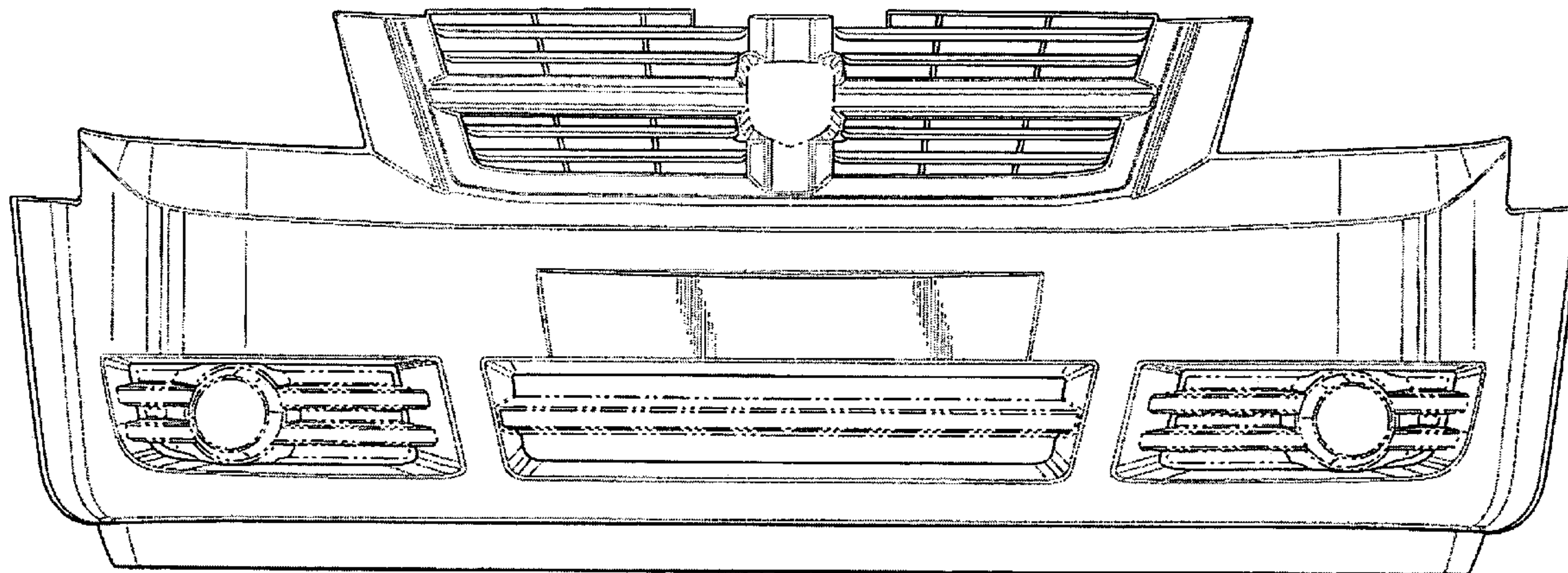

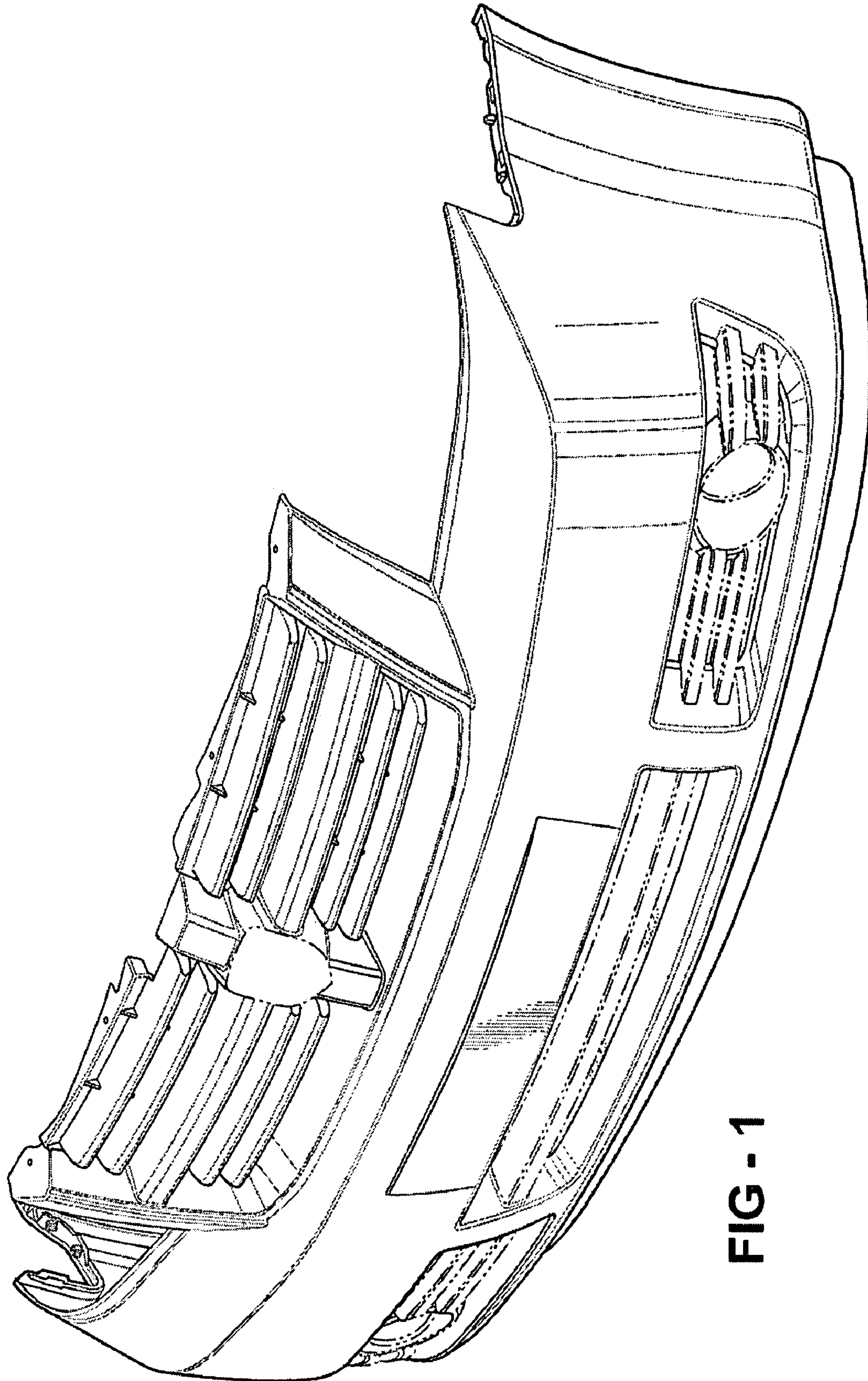

FIG - 1



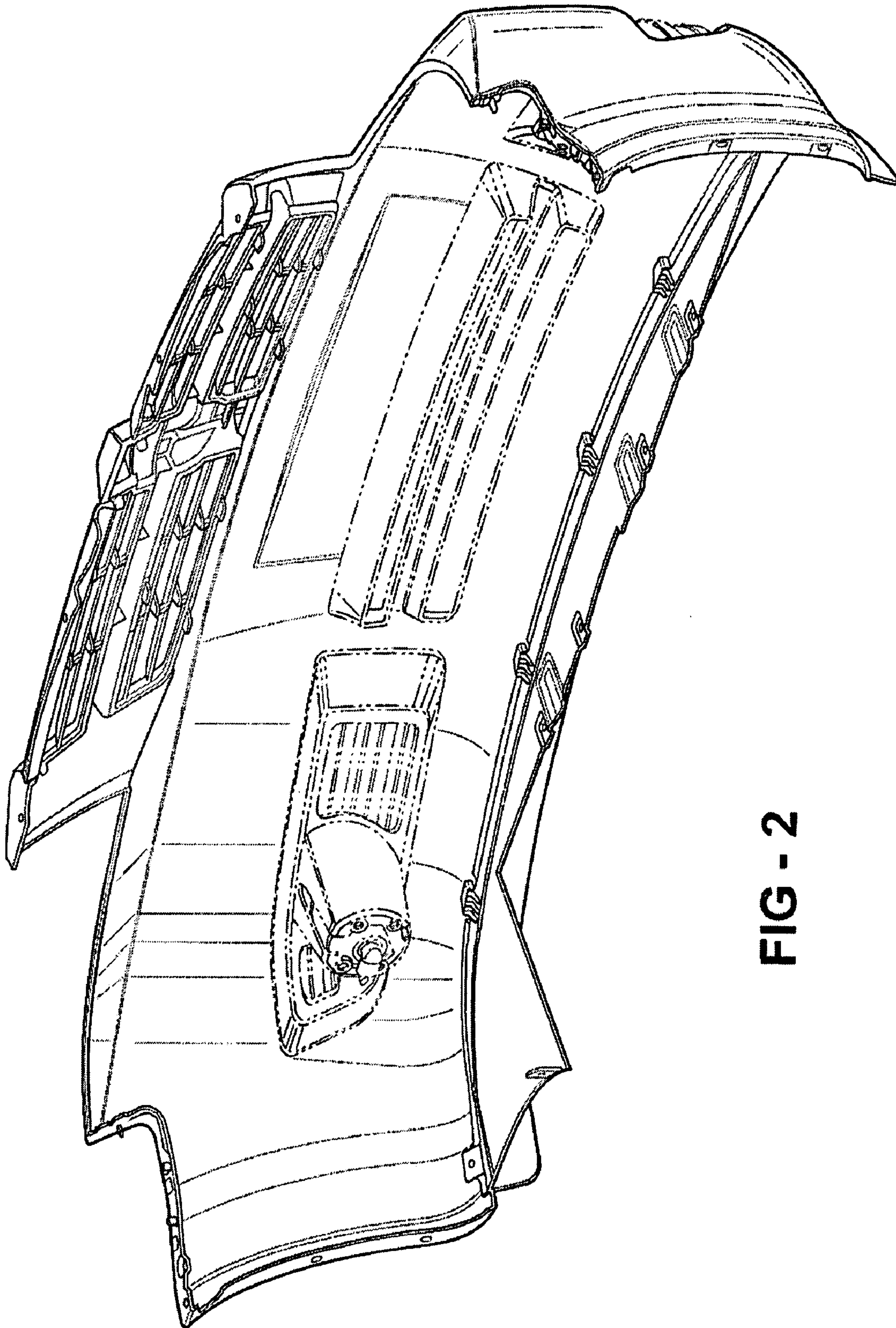

FIG - 2

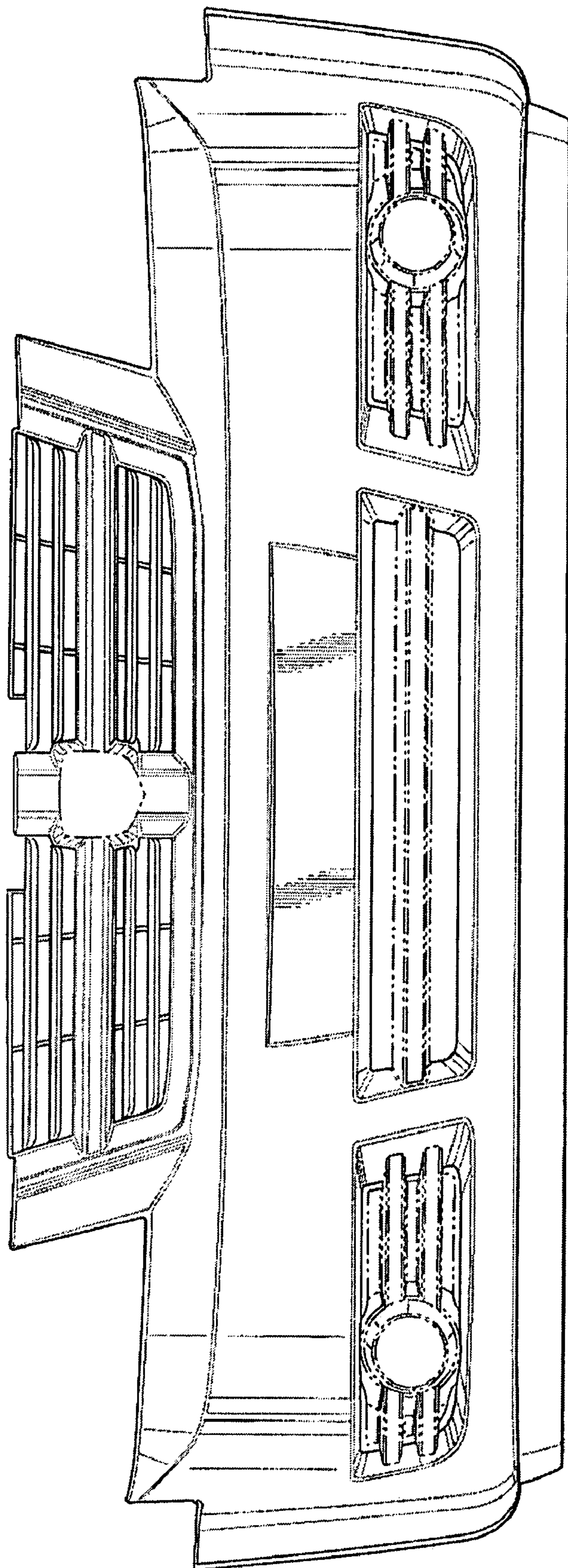

FIG - 3



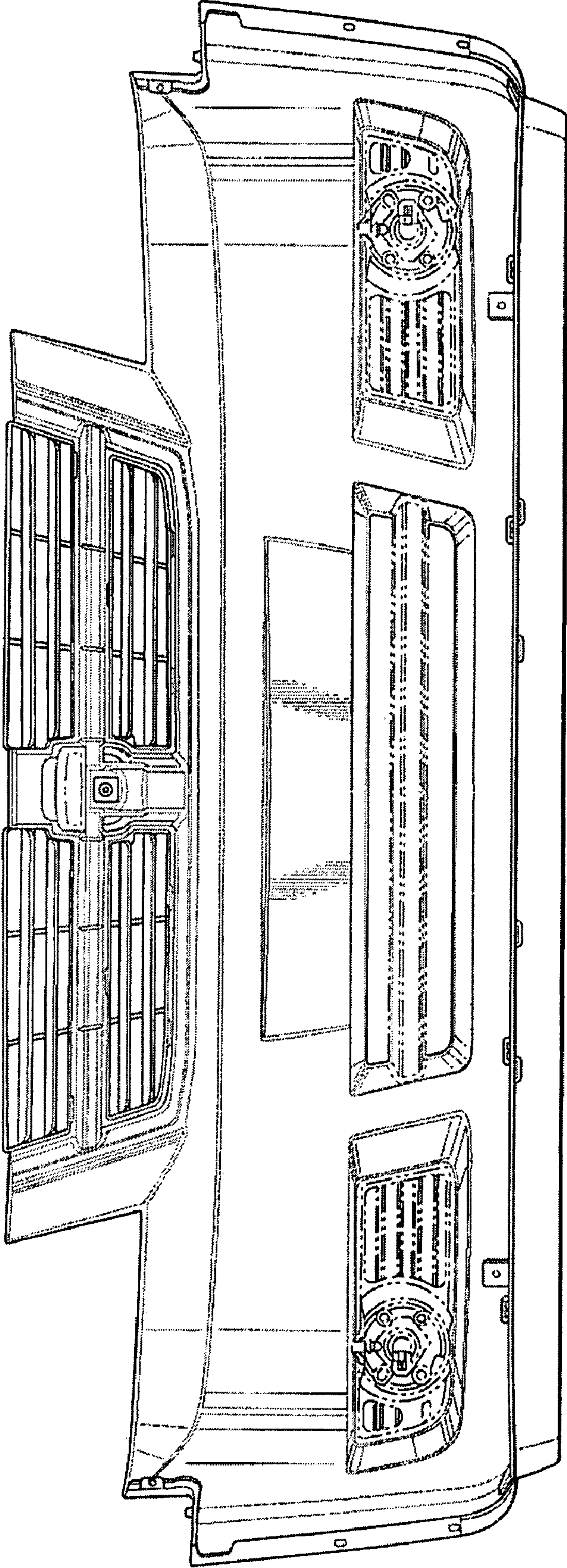

FIG - 4

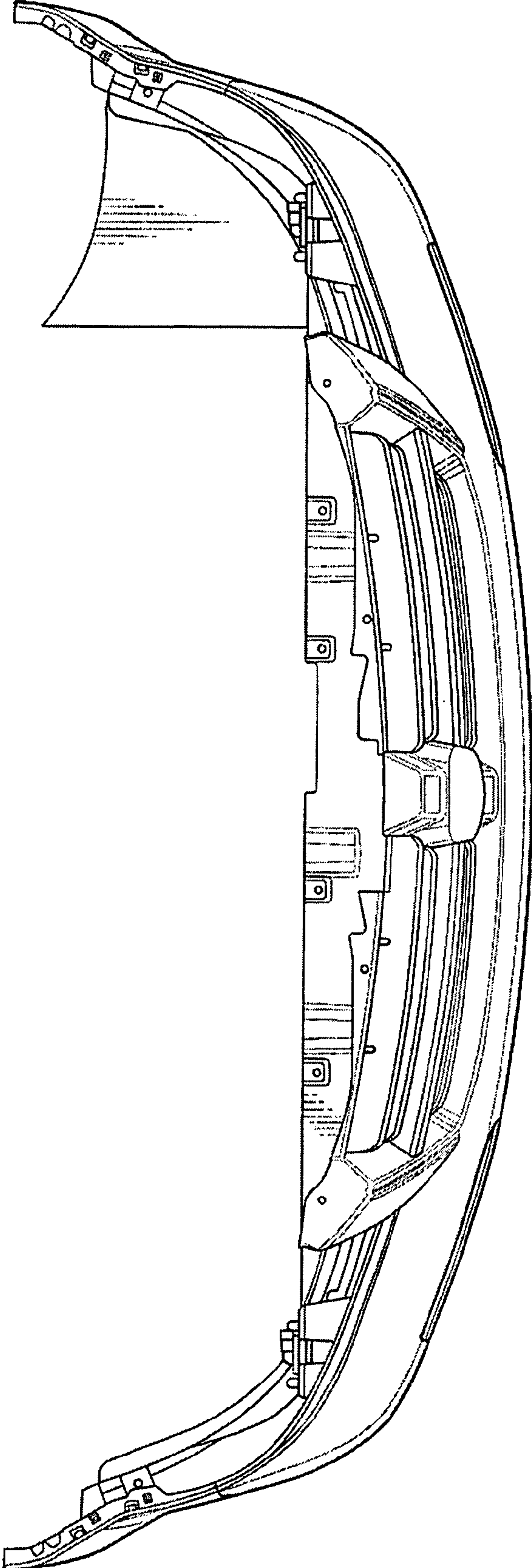

FIG - 5

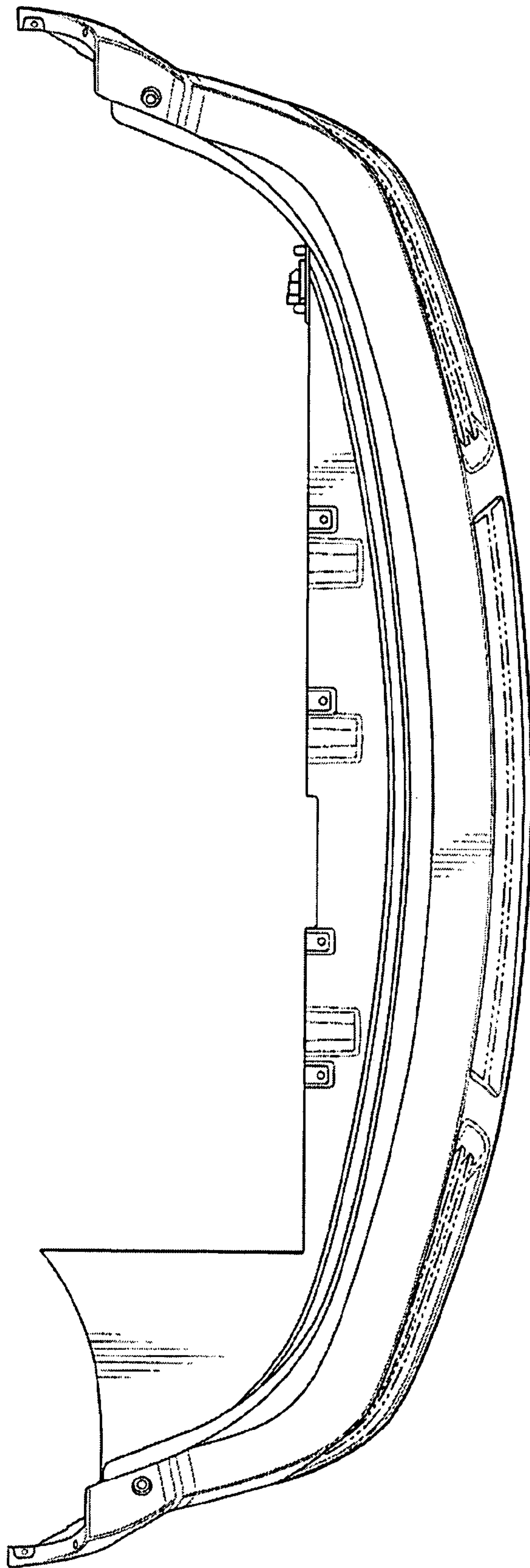

FIG - 6



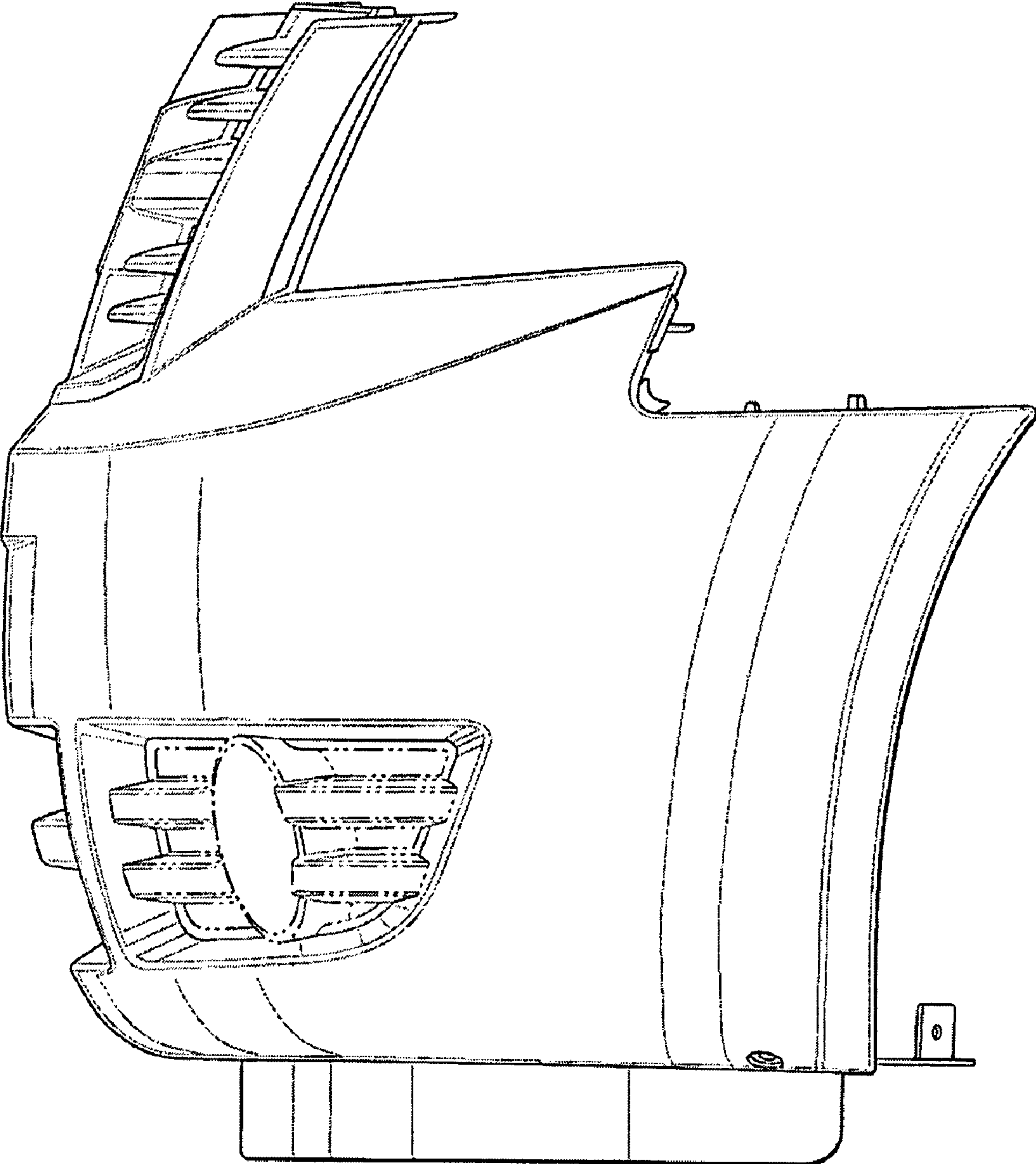

FIG - 7