



US00D575505S

(12) **United States Design Patent**
Morelli

(10) **Patent No.:** **US D575,505 S**

(45) **Date of Patent:** **** Aug. 26, 2008**

(54) **HANDBAG**

(74) *Attorney, Agent, or Firm*—Kalow & Springut, LLP

(75) **Inventor:** **Giovanni Morelli, Milan (IT)**

(57) **CLAIM**

(73) **Assignee:** **Chloe Societe Anonyme, Paris (FR)**

The ornamental design for a handbag, as shown and described.

(**) **Term:** **14 Years**

(21) **Appl. No.:** **29/243,187**

DESCRIPTION

(22) **Filed:** **Nov. 21, 2005**

FIG. 1 is a front perspective view of a handbag showing my new design;

(30) **Foreign Application Priority Data**

FIG. 2 is a front elevational view thereof;

Oct. 7, 2005 (EM) 000354527

FIG. 3 is a rear elevational view thereof;

(51) **LOC (8) Cl.** **03-01**

FIG. 4 is a right side perspective view thereof;

(52) **U.S. Cl.** **D3/243**

FIG. 5 is left side perspective view thereof;

(58) **Field of Classification Search** D3/232,
D3/234, 235, 237, 238, 239, 240, 241, 242,
D3/243, 244, 245, 246, 303, 318, 321, 323,
D3/324, 325, 326, 901; 150/100, 106, 107,
150/110, 111, 112, 114, 115, 117, 118, 119,
150/120, 123, 124, 125, 900; 190/100, 108,
190/109, 112, 113, 115, 116, 119, 121, 122,
190/123, 902; 383/6, 12, 13, 15, 16, 22,
383/24, 25, 30, 31, 37, 38, 40, 41, 42

FIG. 6 is a top plan view thereof;

FIG. 7 is a bottom plan view thereof;

See application file for complete search history.

FIG. 8 is a front perspective view of a second embodiment thereof;

FIG. 9 is an enlarged perspective view of the lock portion thereof;

FIG. 10 is alternate enlarged perspective view of the lock portion thereof;

FIG. 11 is an enlarged perspective view of the key and key strap portion thereof;

(56) **References Cited**

U.S. PATENT DOCUMENTS

D487,969 S * 4/2004 Galliano D3/243
D492,482 S * 7/2004 Hanley D3/243
D522,236 S * 6/2006 Stulman D3/239
D525,783 S * 8/2006 Martilla D3/239
D532,969 S * 12/2006 Fendi D3/243
D534,723 S * 1/2007 Fusi D3/243

FIG. 12 is an enlarged elevational view of the strap fastener portion thereof; and,

FIG. 13 is an enlarged elevational view of the buckle attachment portion thereof.

The broken lines showing a handbag are for the illustrative purposes only and form no part of the claimed design. The broken lines shown within the full line disclosure portions of the claimed design are understood to represent stitching and form no part of the claimed design.

* cited by examiner

Primary Examiner—Lou Zarfes

Assistant Examiner—Monica A Weingart

1 Claim, 13 Drawing Sheets

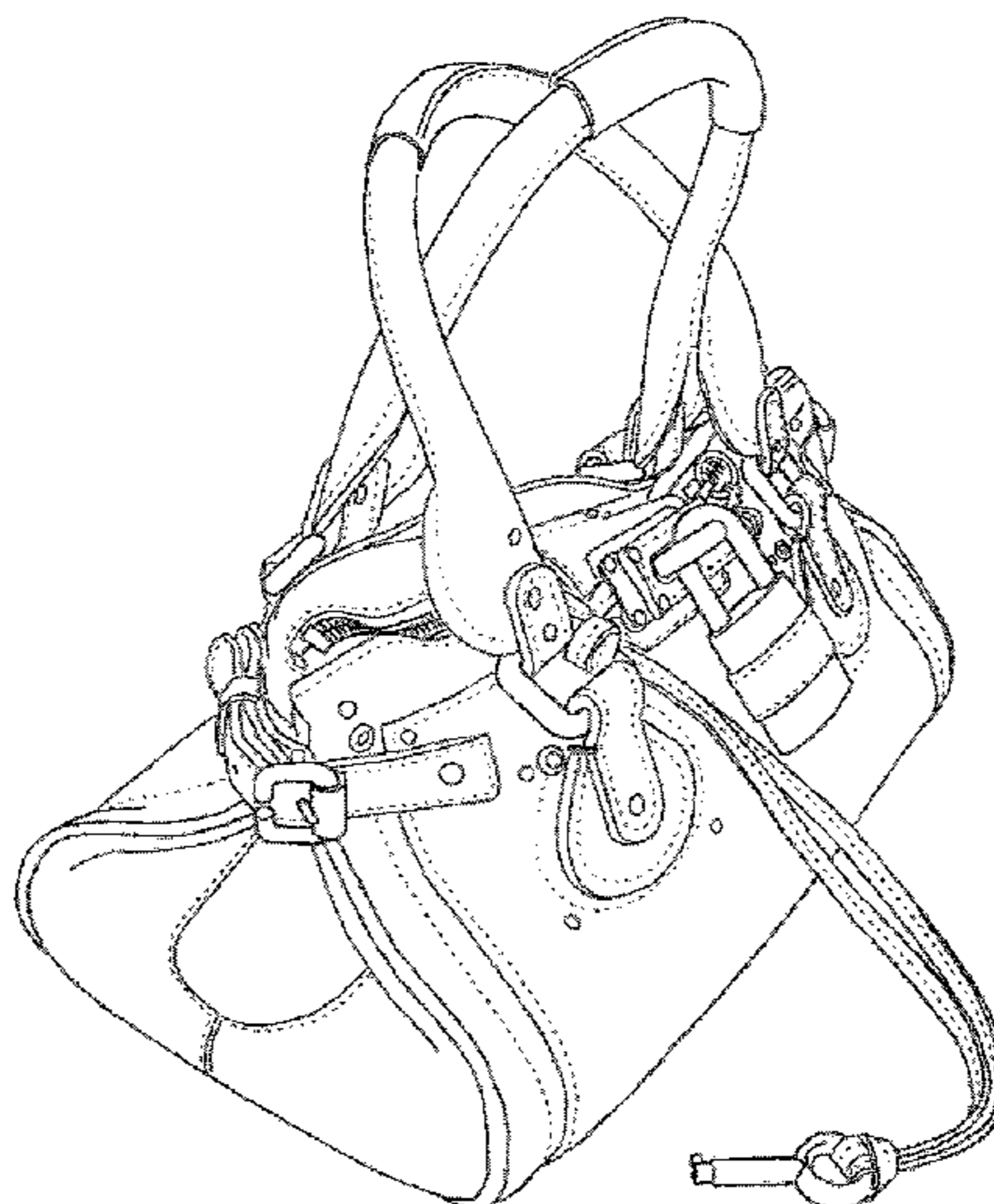

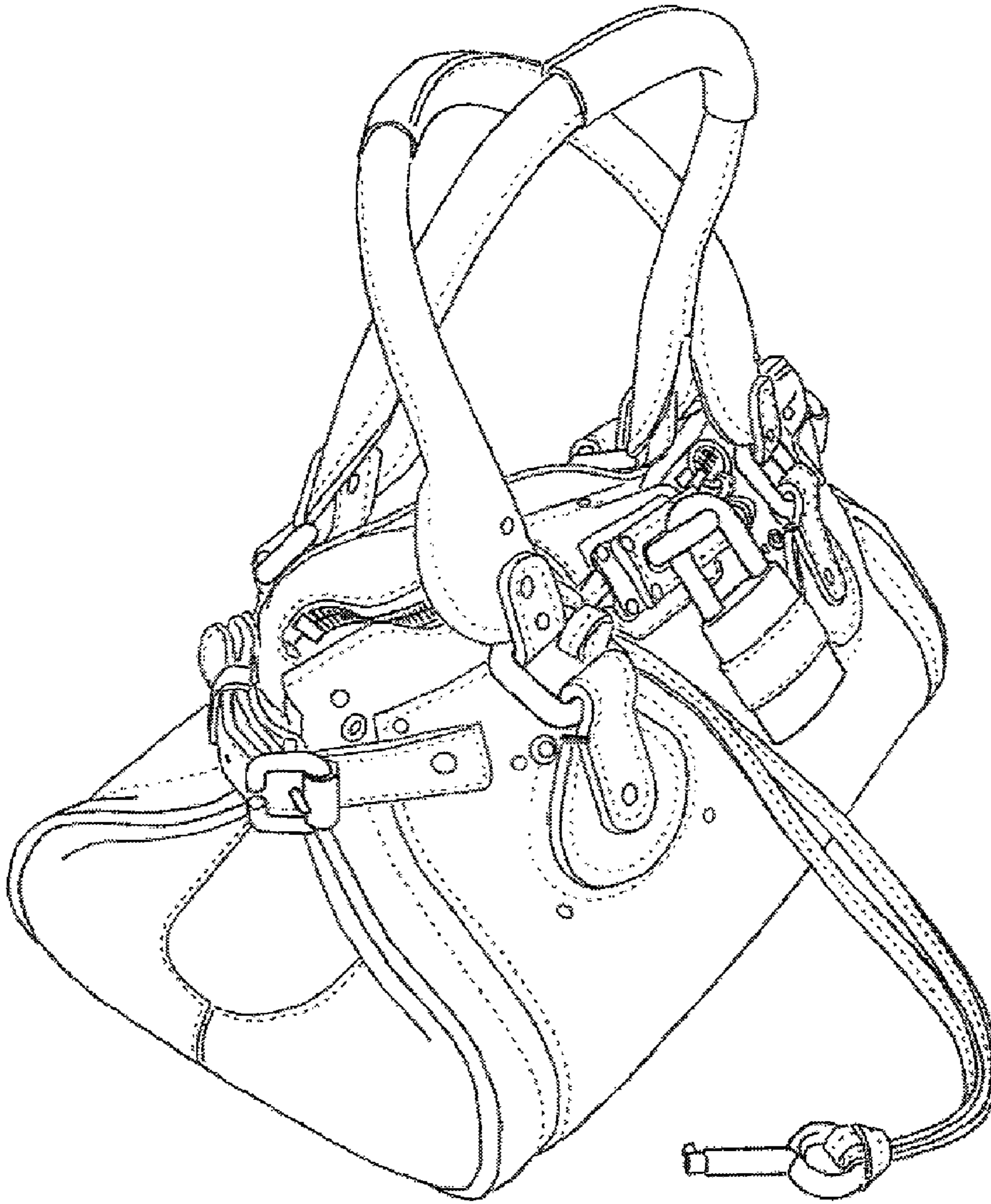

Fig. 1

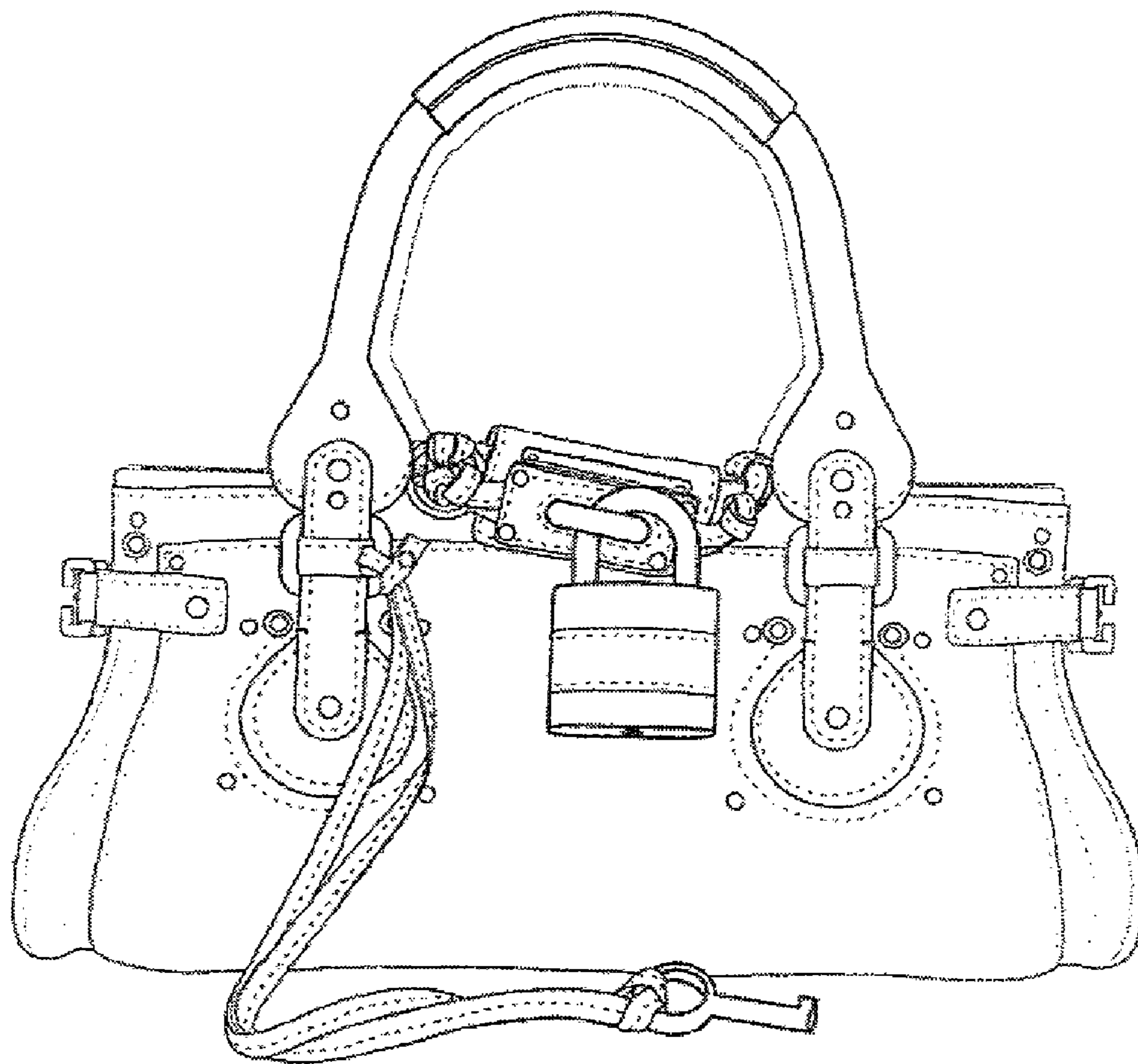

Fig. 2

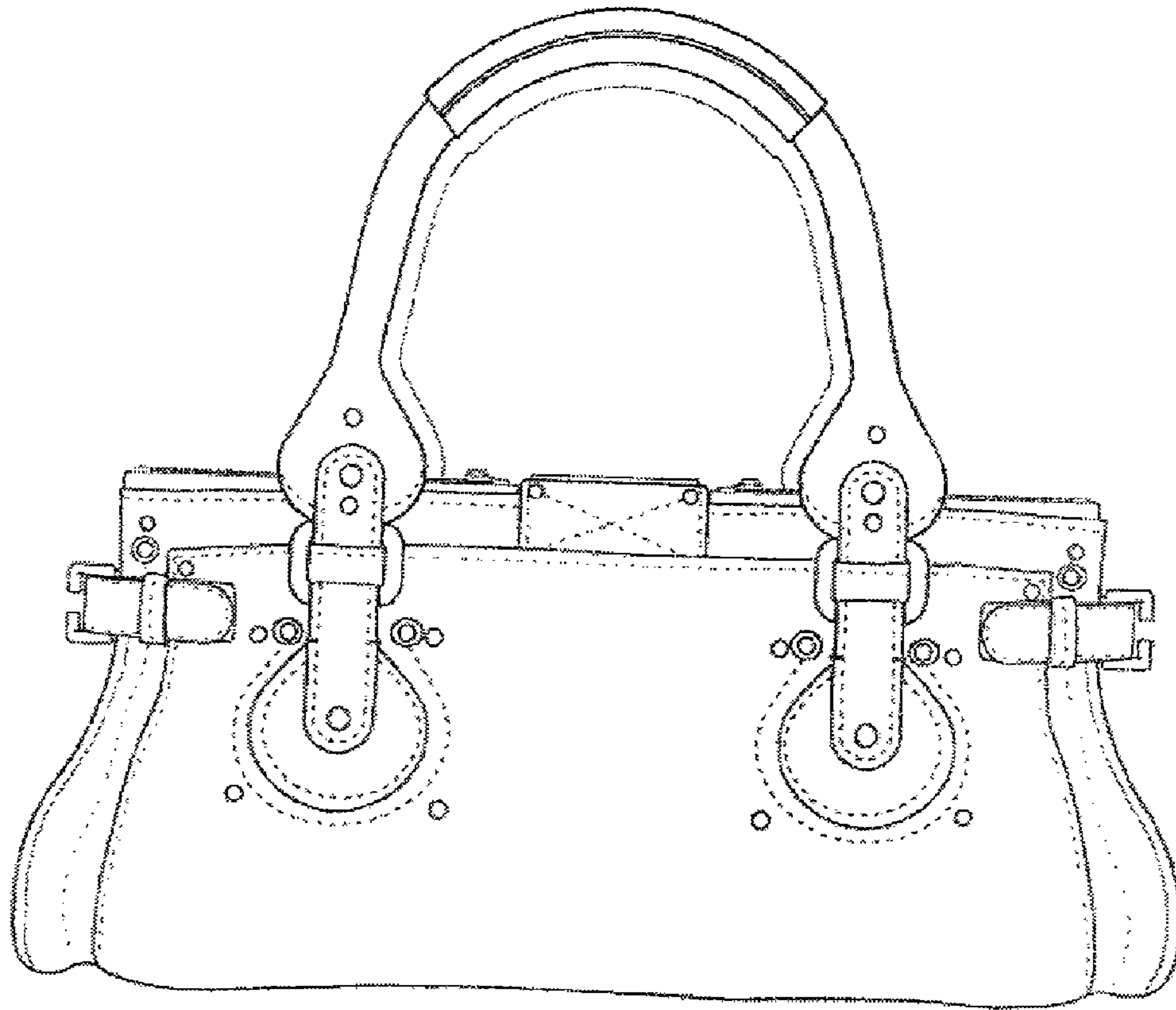

Fig. 3

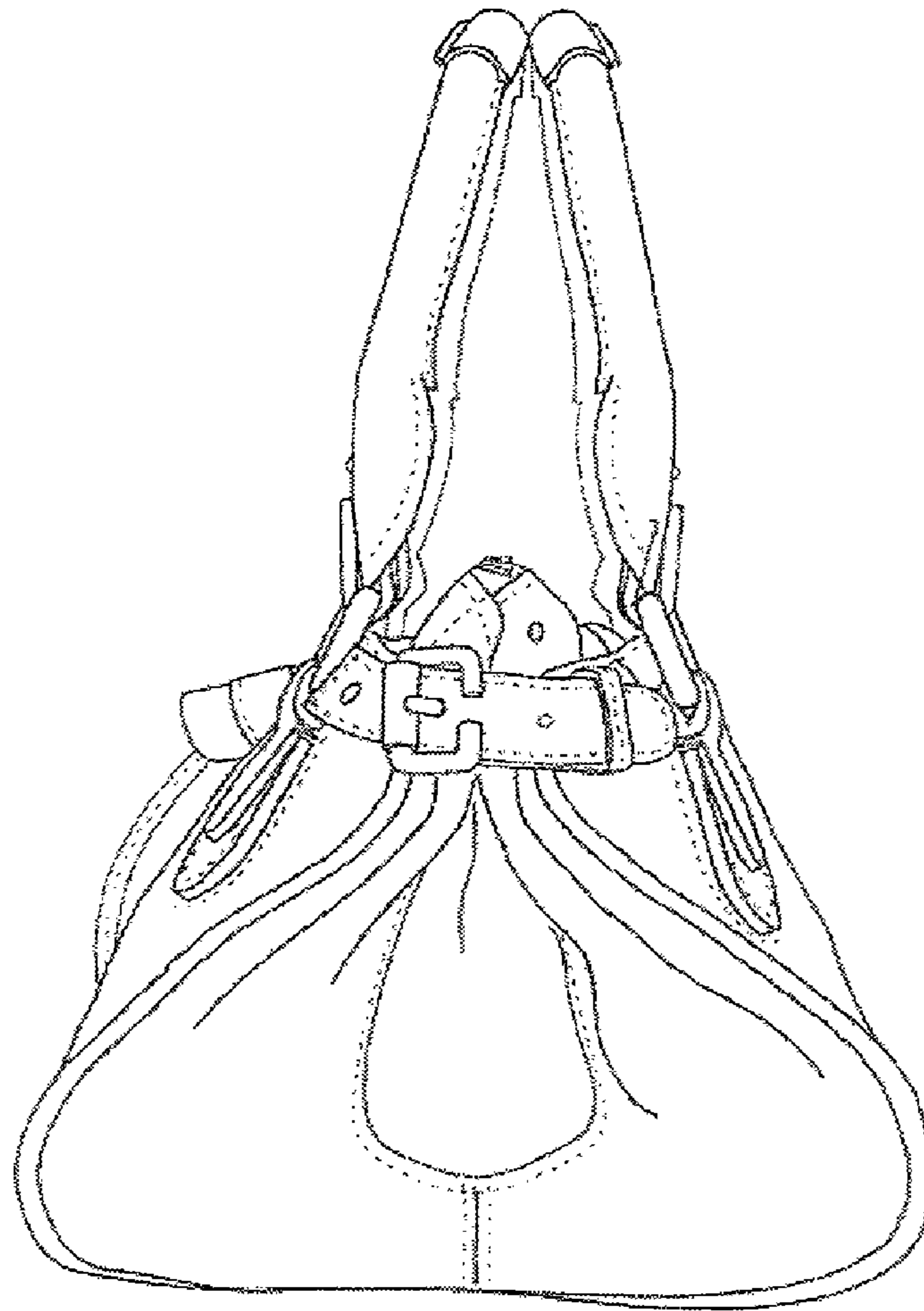

Fig. 4

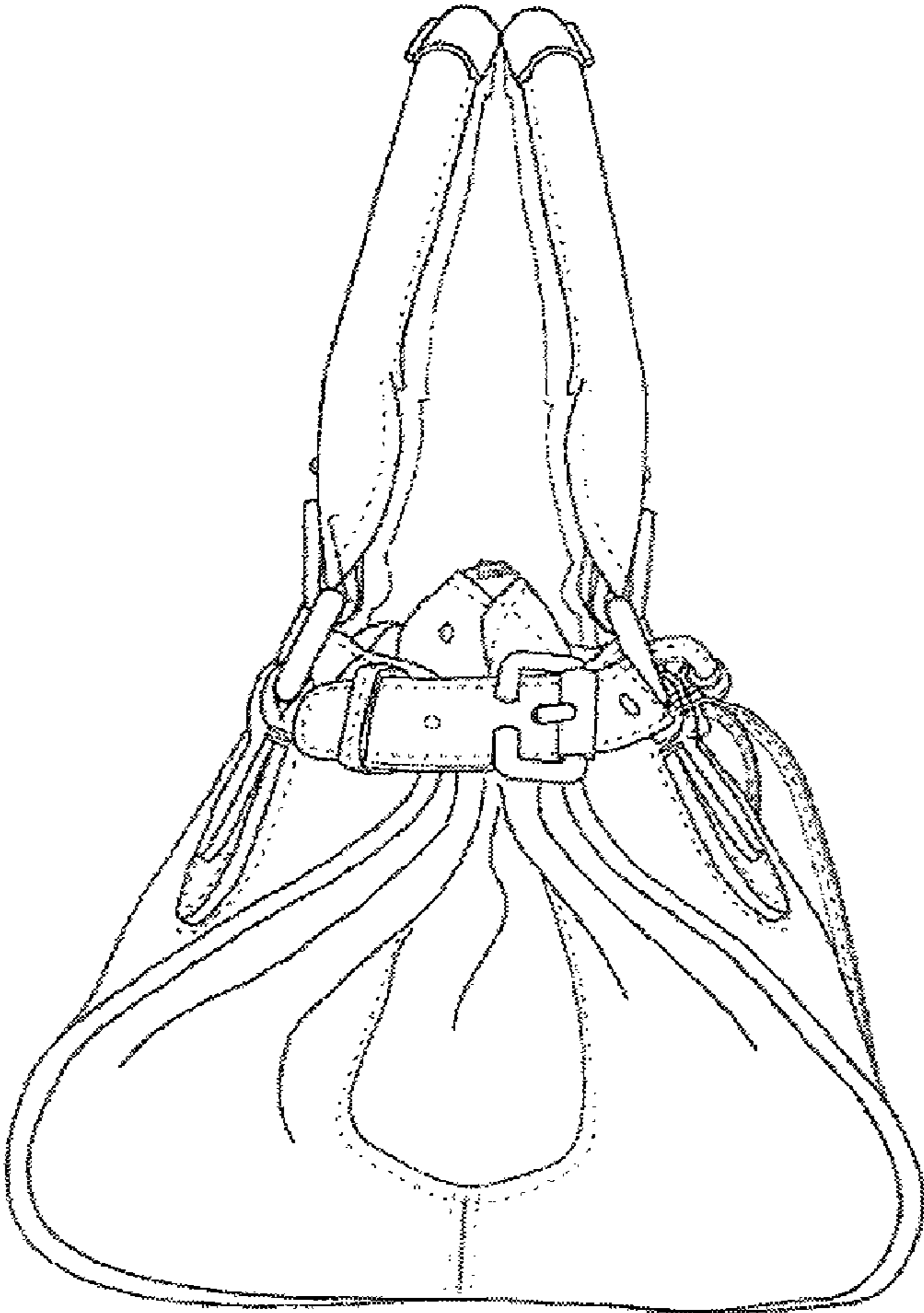

Fig. 5

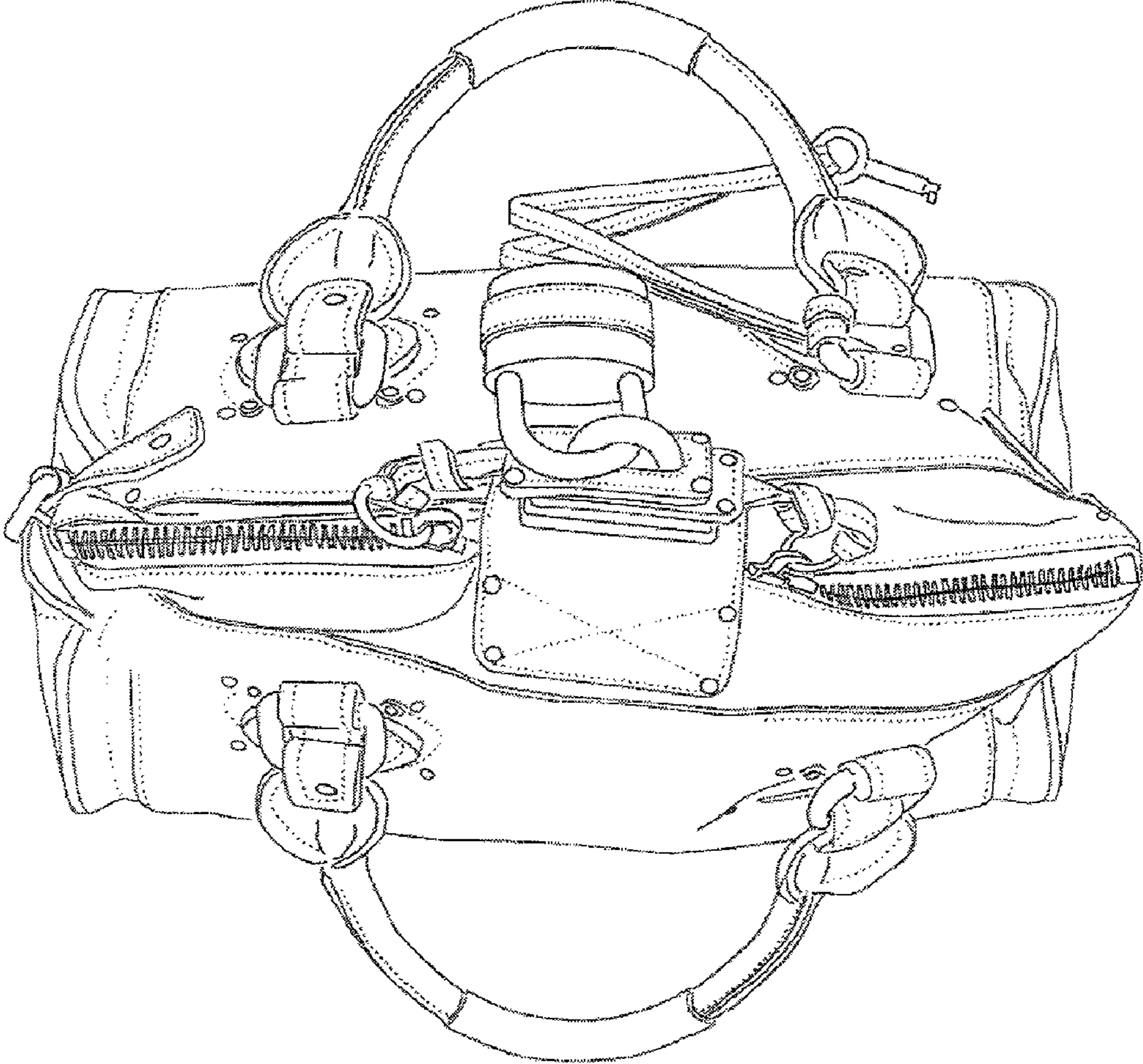

Fig. 6

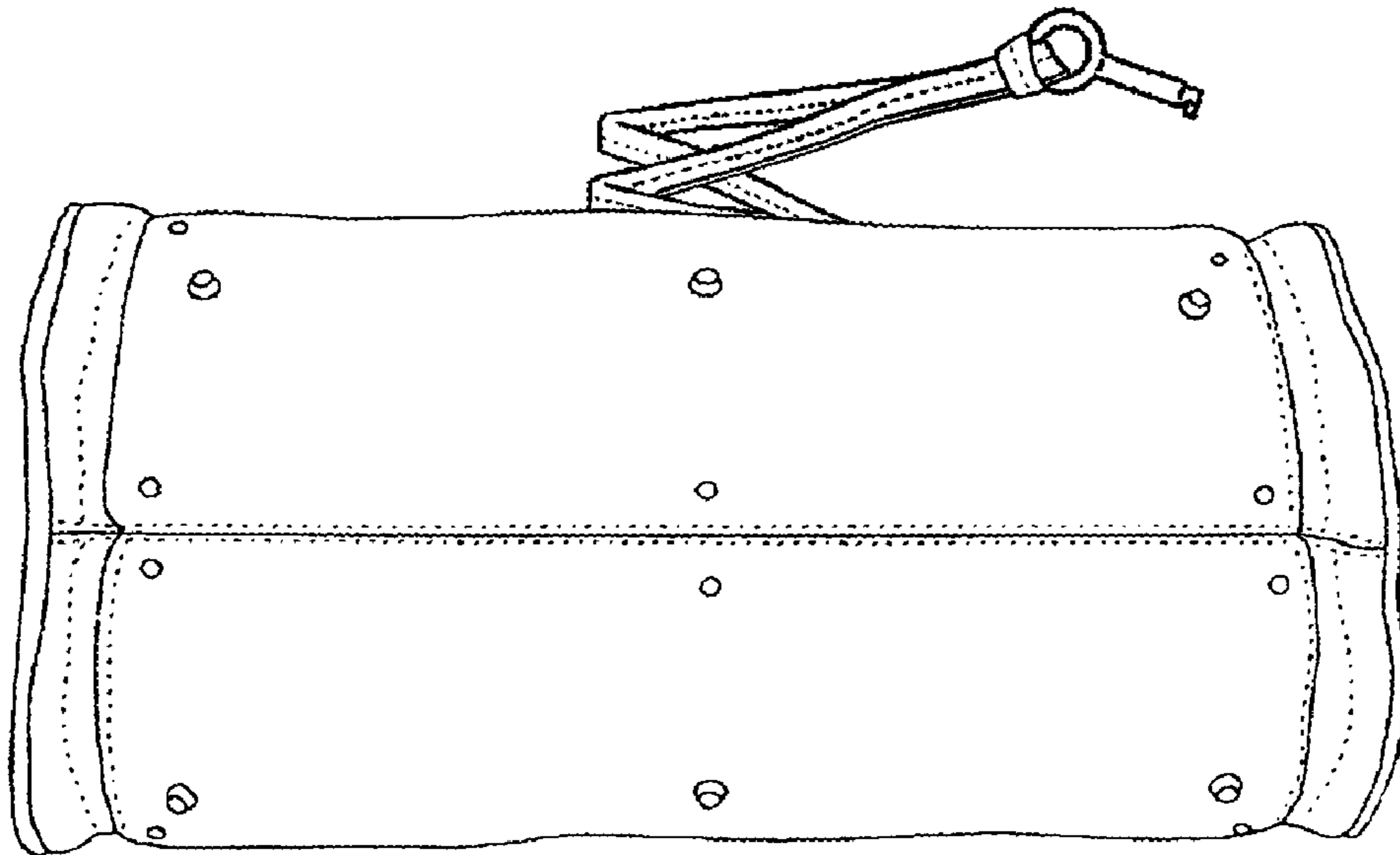

FIG. 7

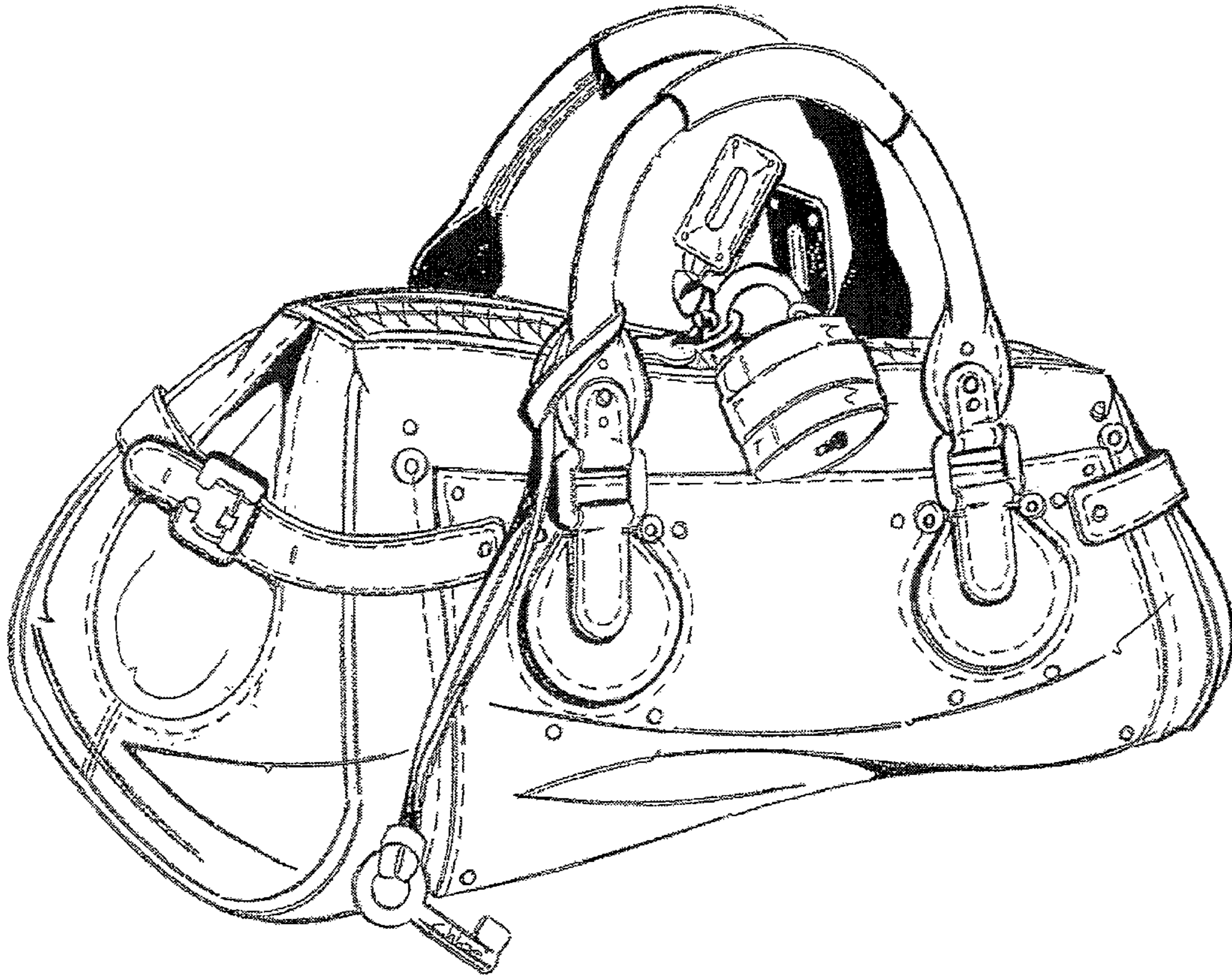

Fig. 8

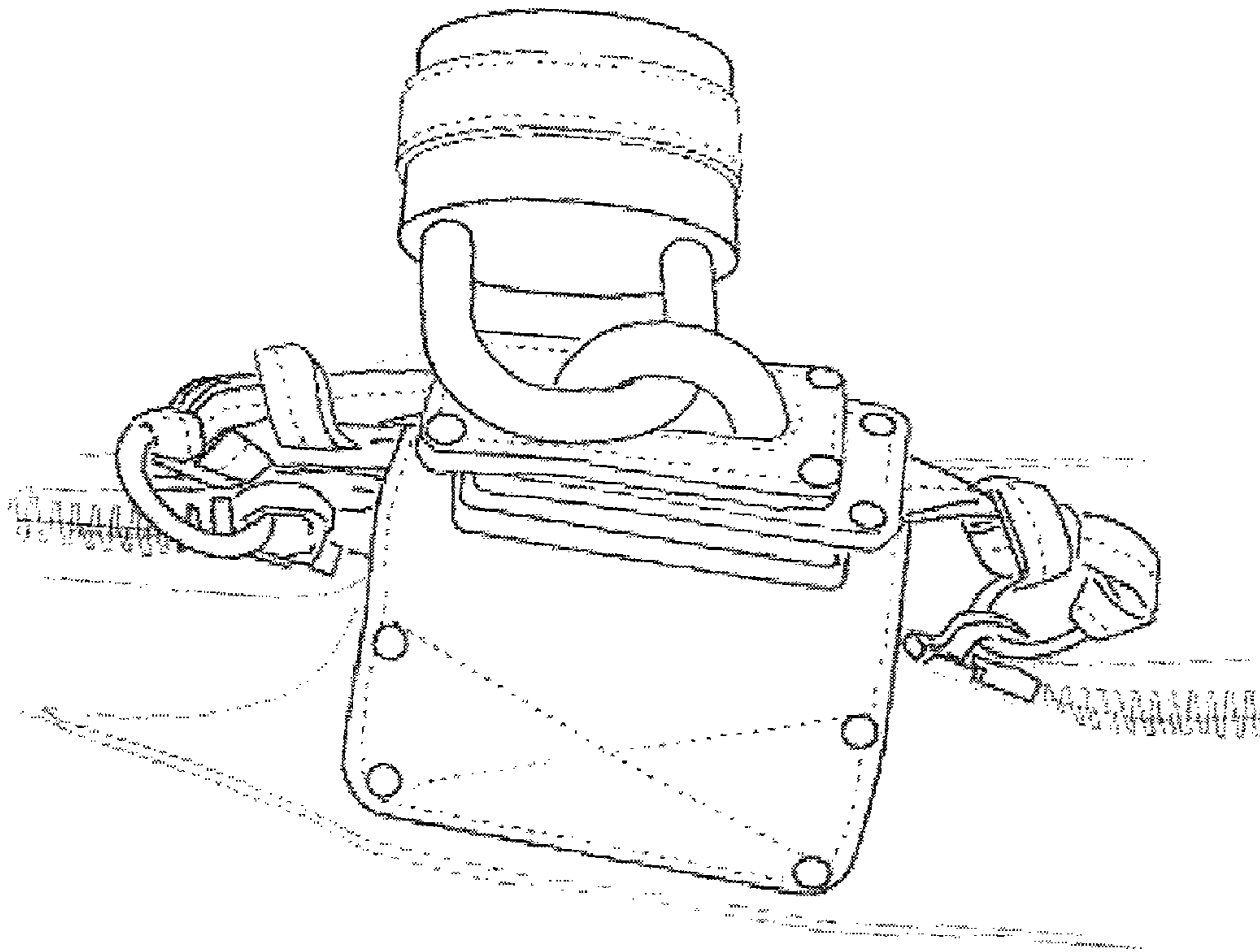

Fig. 9

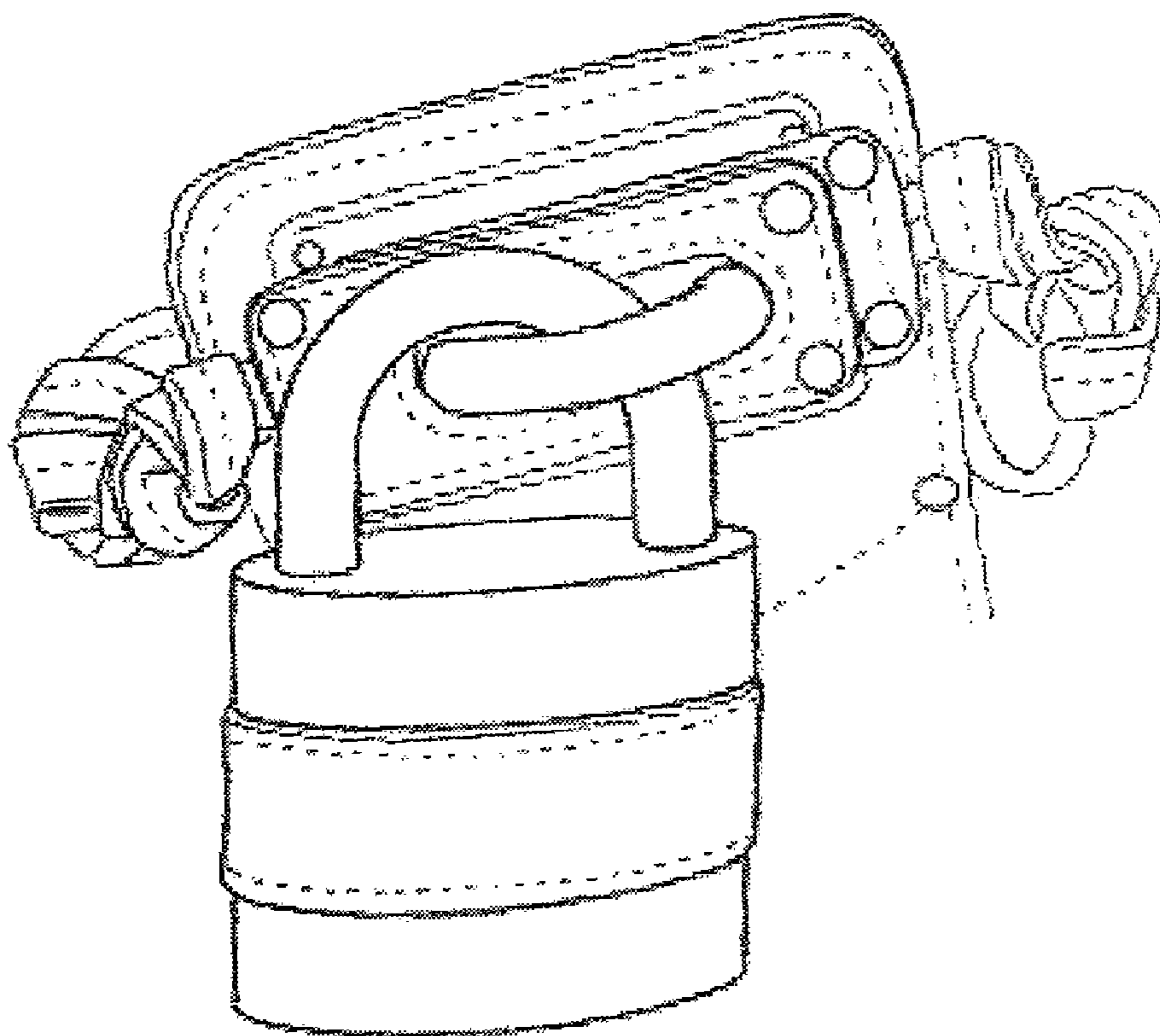

Fig. 10

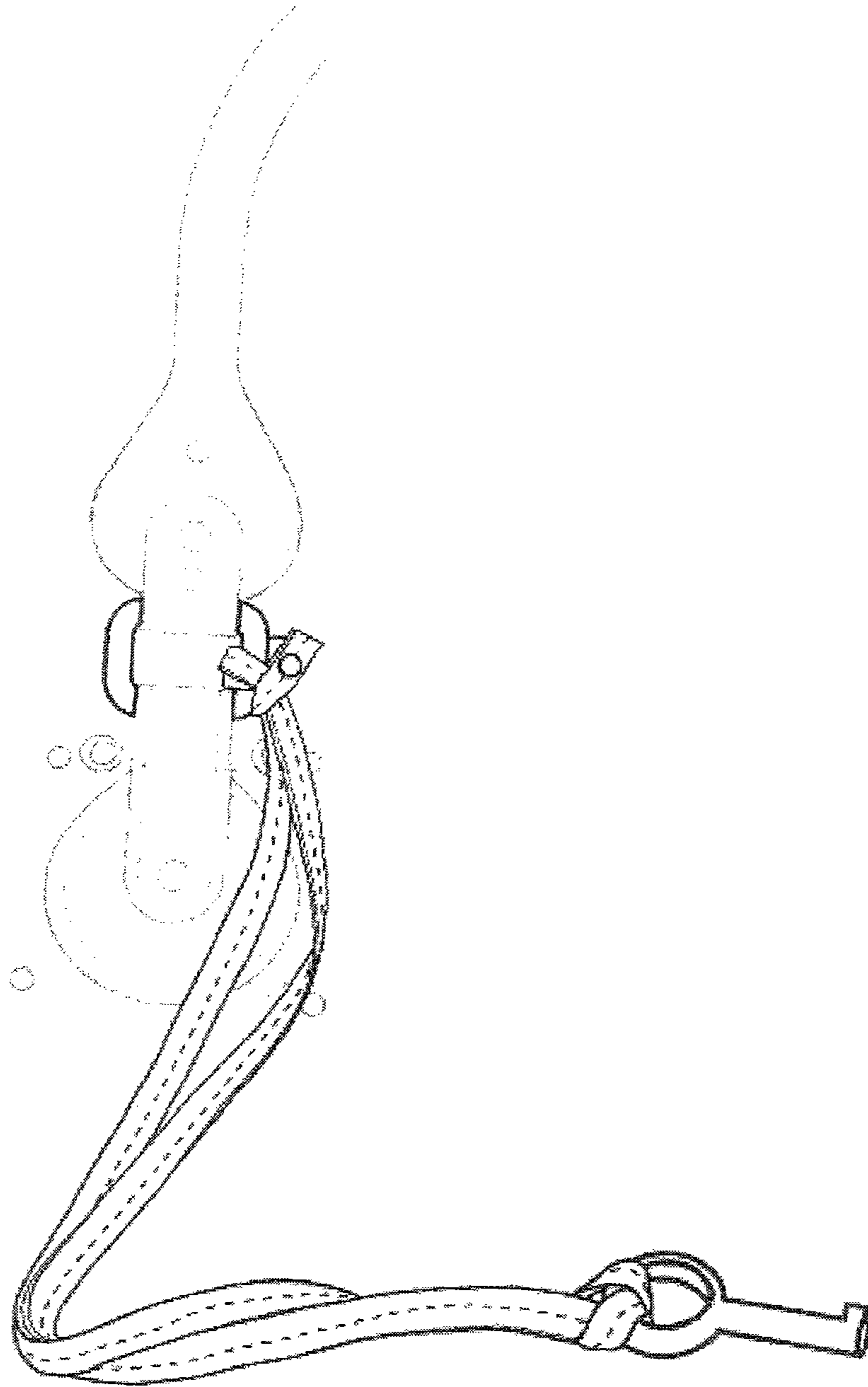

Fig. 11

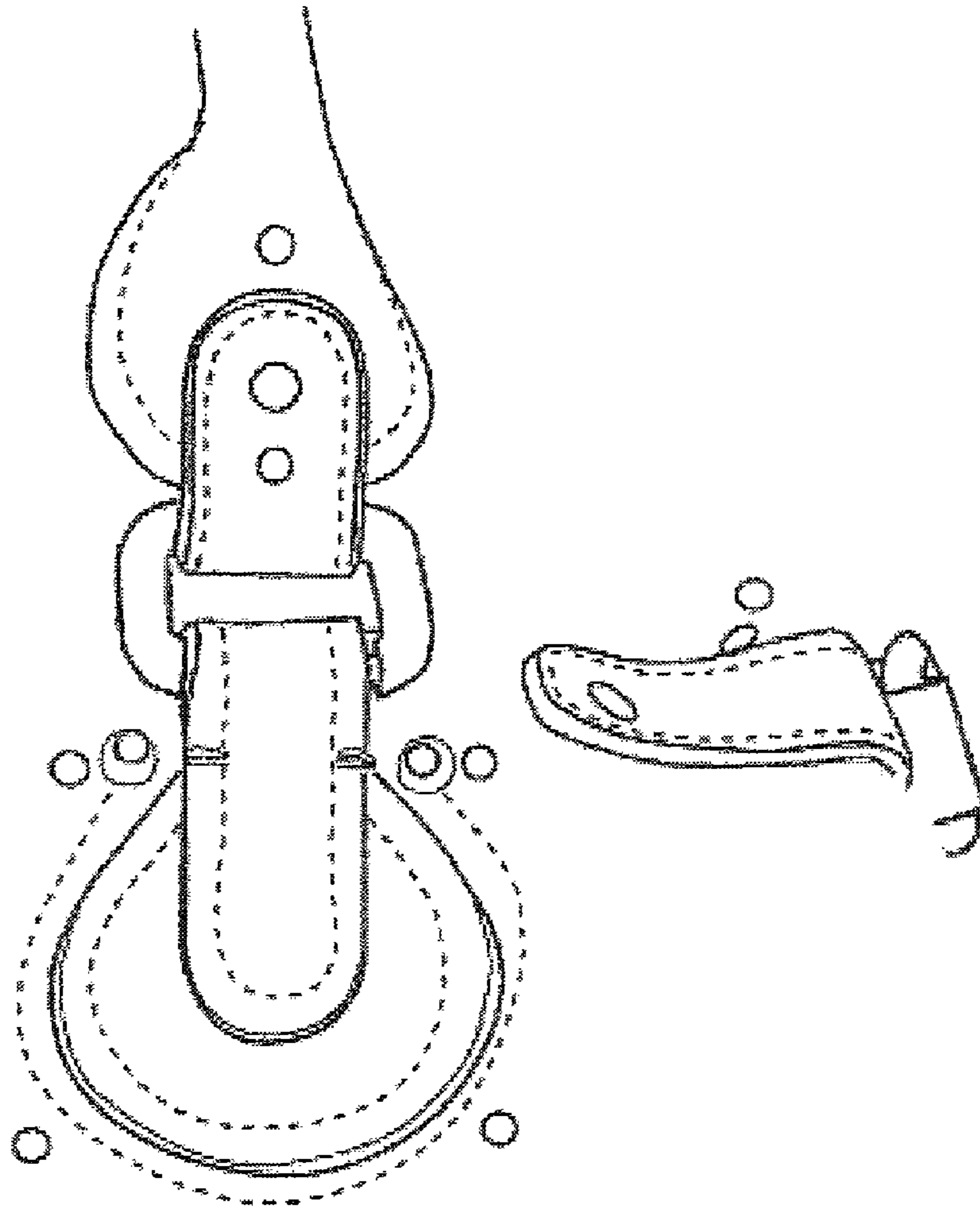

Fig. 12

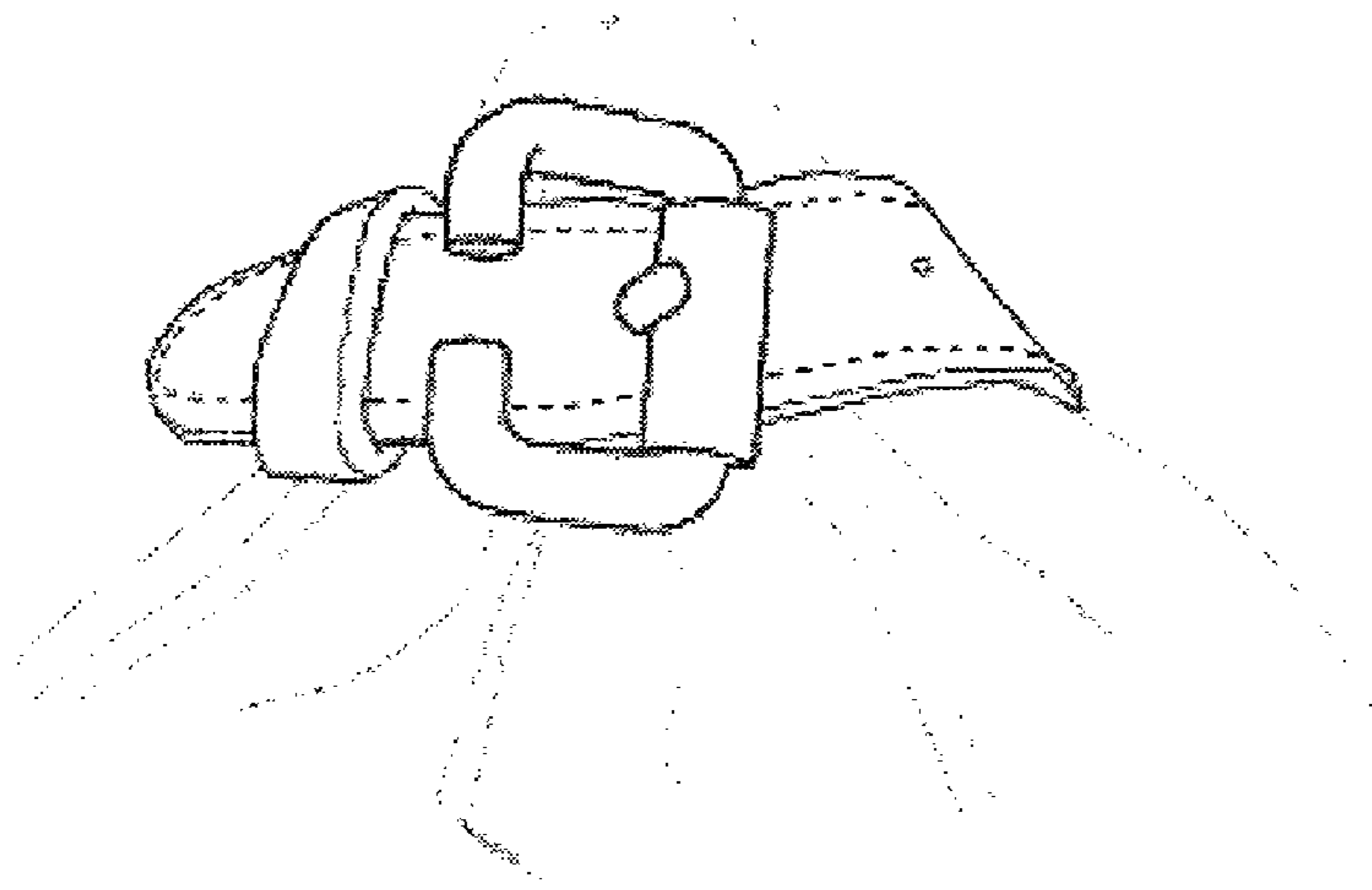

Fig. 13