



US00D575458S

(12) **United States Design Patent**  
**Ho**

(10) **Patent No.:** **US D575,458 S**

(45) **Date of Patent:** **\*\* Aug. 19, 2008**

(54) **BASEBALL HELMET**

(76) Inventor: **Chang Hsien Ho**, No. 158, Sec. 2,  
Dongning Rd., Jhudong Township,  
Hsinchu county 310 (TW)

(\*\*) Term: **14 Years**

(21) Appl. No.: **29/271,455**

(22) Filed: **Jan. 19, 2007**

(51) **LOC (8) Cl.** ..... **29-02**

(52) **U.S. Cl.** ..... **D29/106**

(58) **Field of Classification Search** ..... D29/102-111,  
D29/122; 2/410-414, 416-425, 5, 6.6-6.8,  
2/9

See application file for complete search history.

(56) **References Cited**

**U.S. PATENT DOCUMENTS**

D289,569 S *	4/1987	Nimmons	.....	D29/111
D309,512 S *	7/1990	Crow	.....	D29/105
D358,686 S *	5/1995	Kraemer	.....	D29/111
D385,662 S *	10/1997	Paglucci et al.	.....	D29/105
D389,958 S *	1/1998	Kinthead	.....	D29/102
D402,414 S *	12/1998	Smith	.....	D29/106
D479,019 S *	8/2003	Lishen	.....	D29/102
D508,298 S *	8/2005	Bernacchi et al.	.....	D29/111

D511,225 S *	11/2005	Brown et al.	.....	D29/106
D512,534 S *	12/2005	Maddux et al.	.....	D29/106
D514,259 S *	1/2006	Brown et al.	.....	D29/106
D552,800 S *	10/2007	Ho	.....	D29/105

\* cited by examiner

*Primary Examiner*—Ruth McInroy

(74) *Attorney, Agent, or Firm*—Troxell Law Office, PLLC

(57) **CLAIM**

The ornamental design for baseball helmet, shown and described.

**DESCRIPTION**

FIG. 1 is a front and right-side perspective view of a baseball helmet showing my new design;

FIG. 2 is a rear side perspective view thereof;

FIG. 3 is a front elevational view thereof;

FIG. 4 is a rear elevational view thereof;

FIG. 5 is a left side elevational view thereof;

FIG. 6 is a right side elevational view thereof;

FIG. 7 is a top view thereof; and,

FIG. 8 is a bottom view thereof.

**1 Claim, 5 Drawing Sheets**

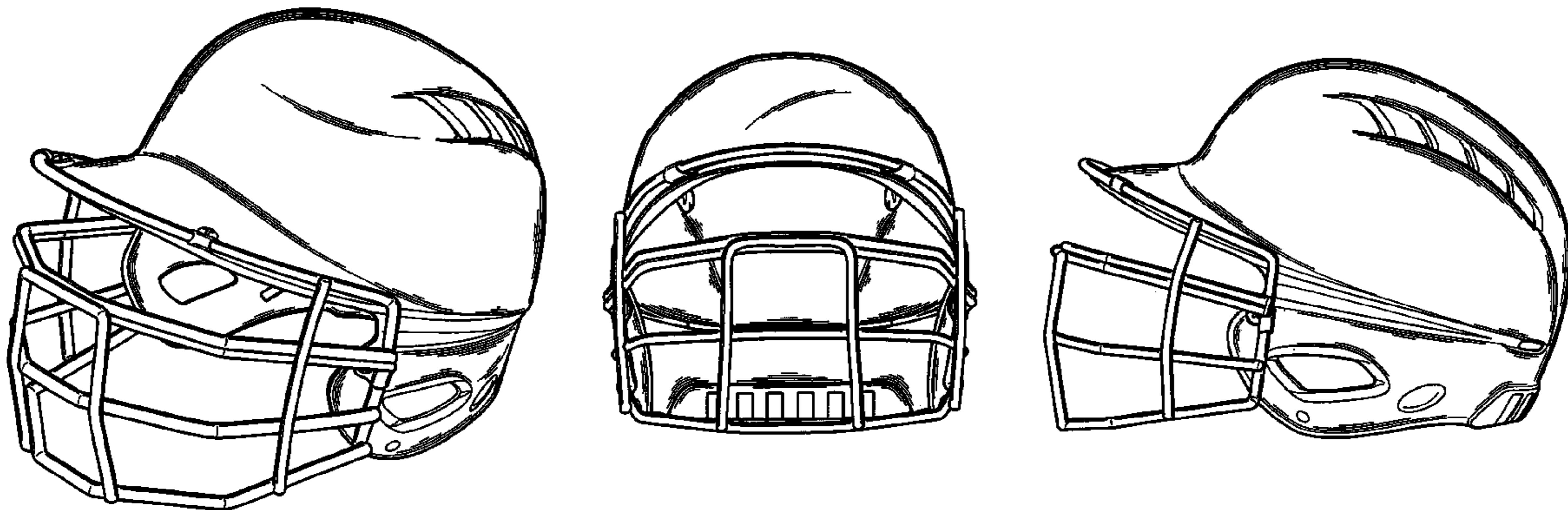

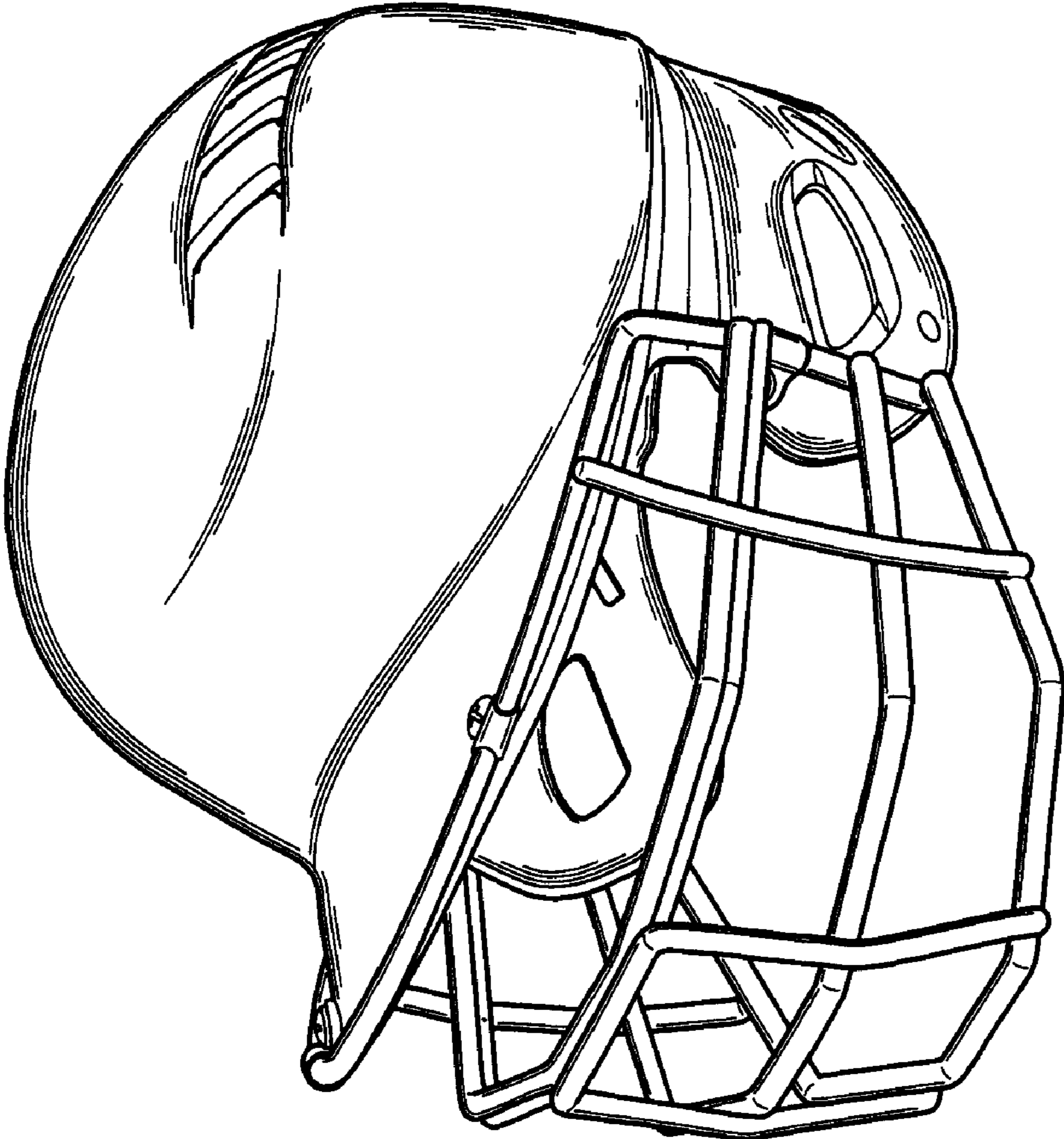

Fig. 1

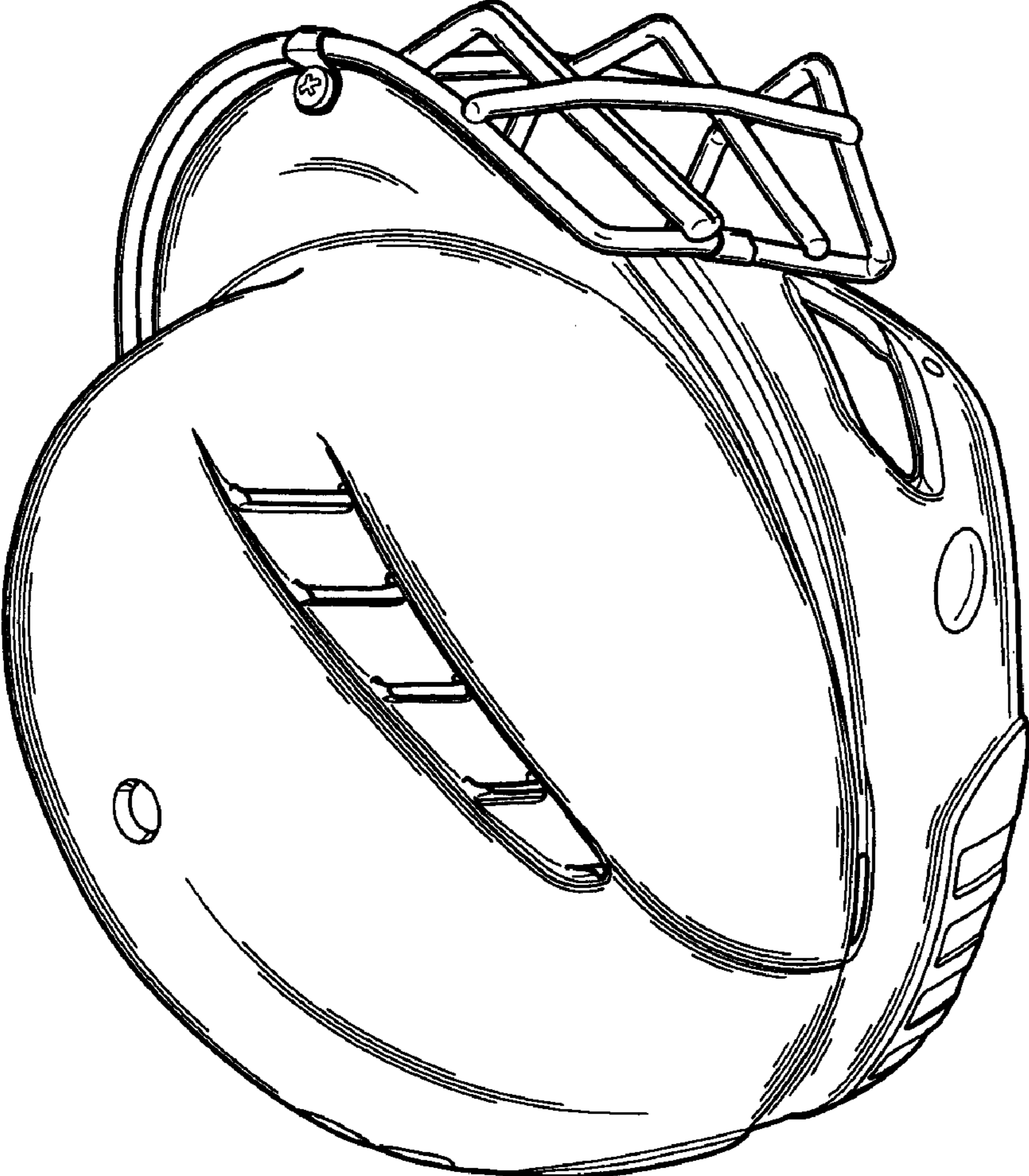

Fig. 2

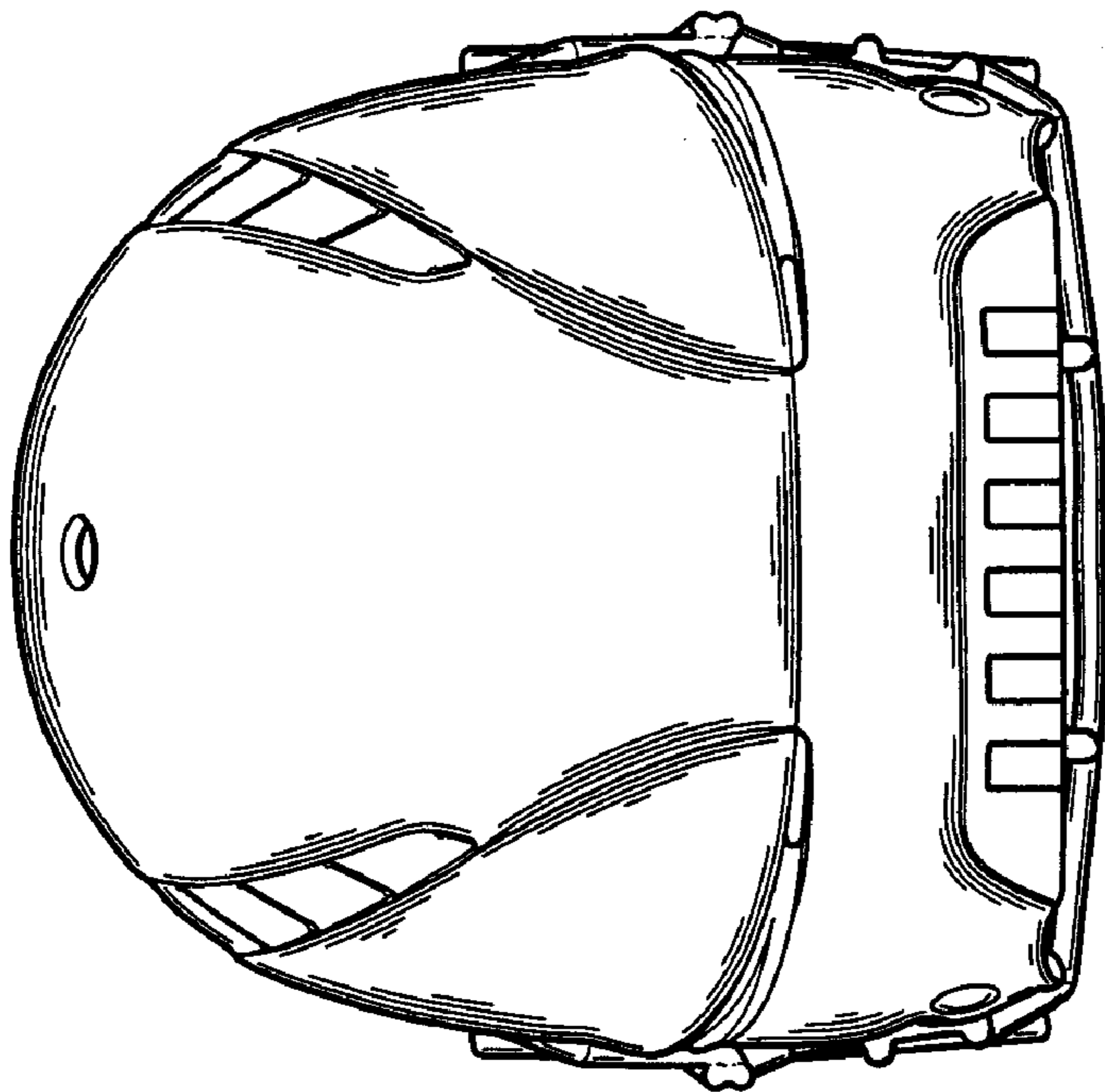

Fig. 4

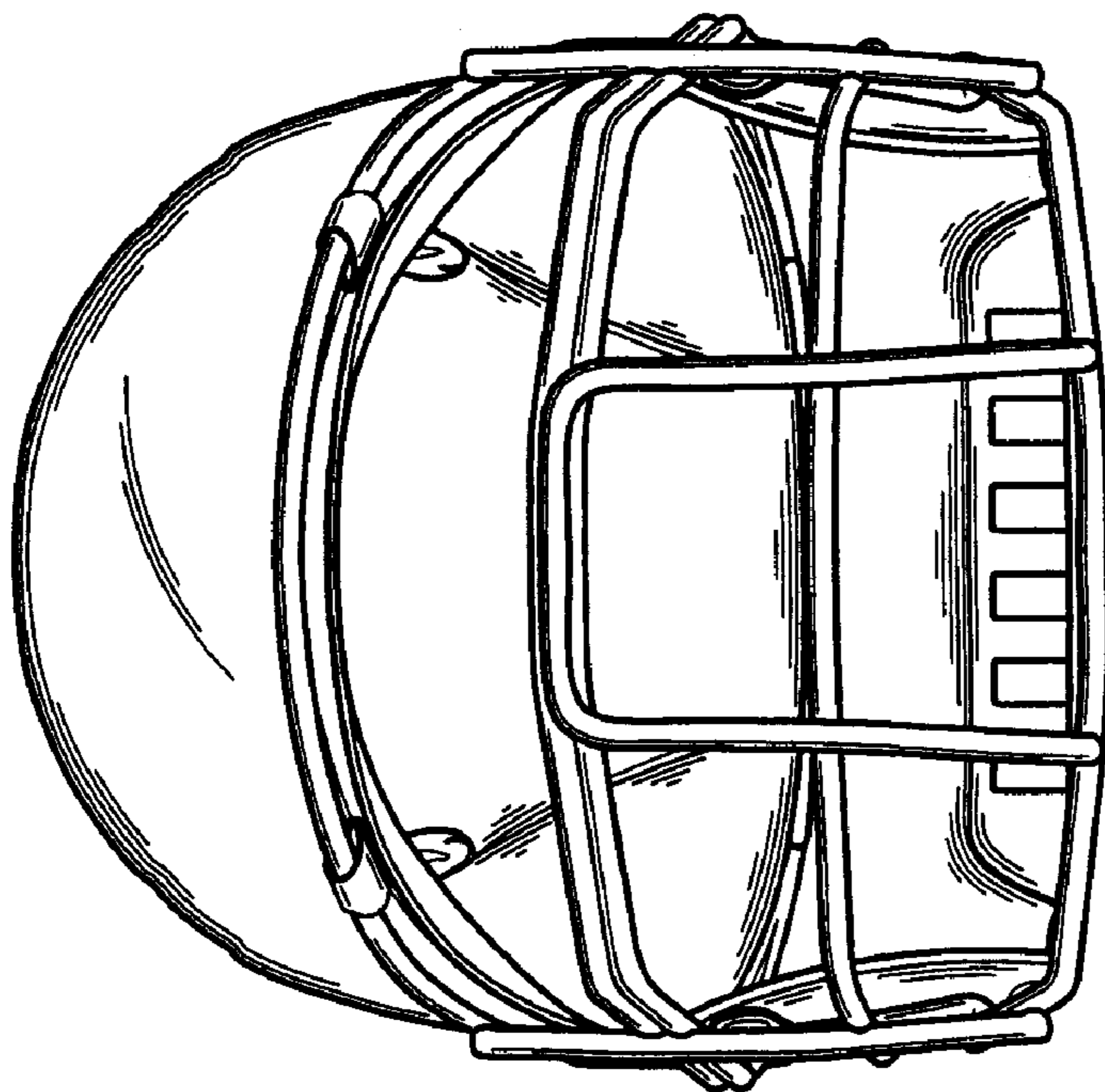

Fig. 3

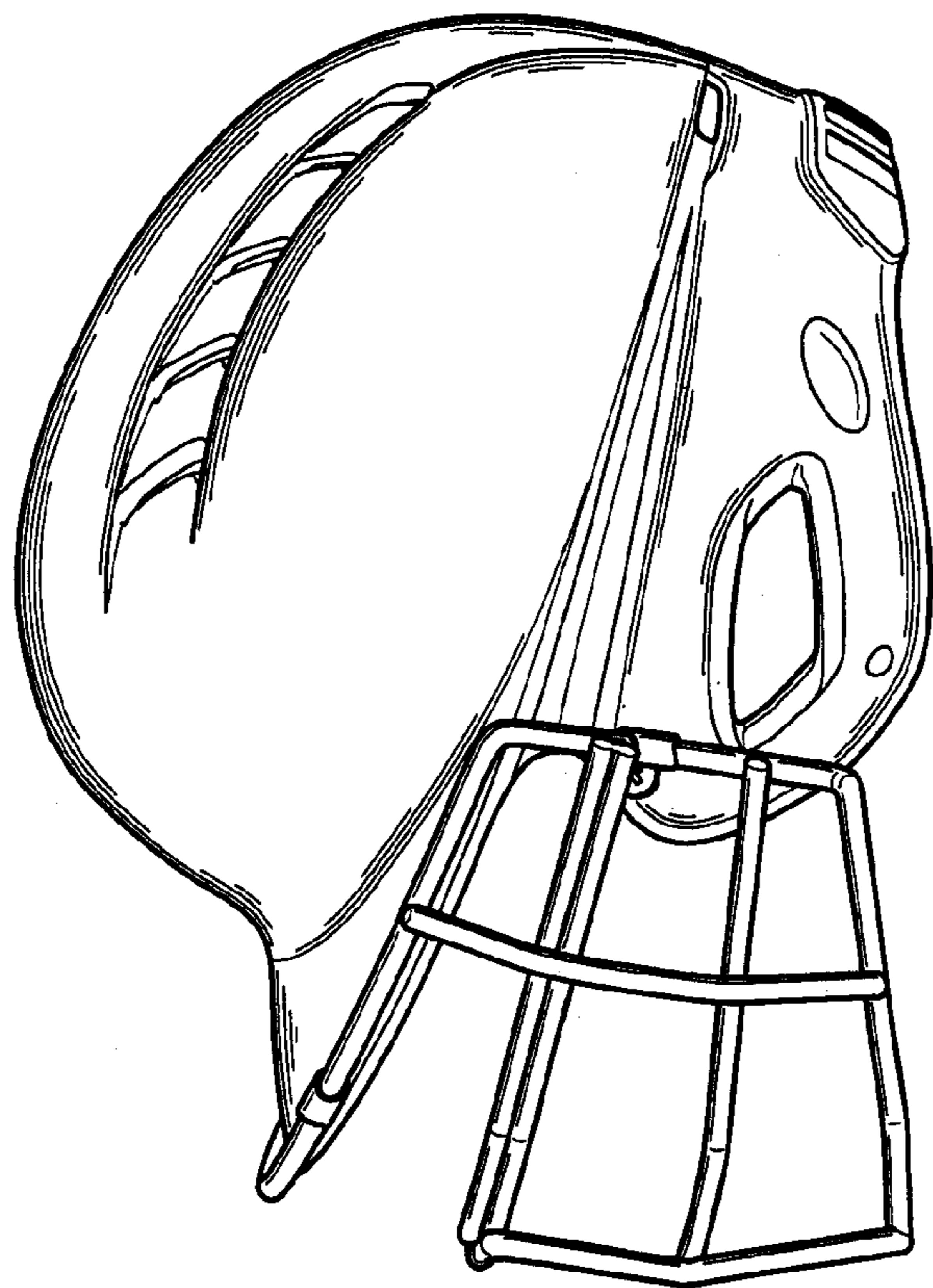

Fig. 6

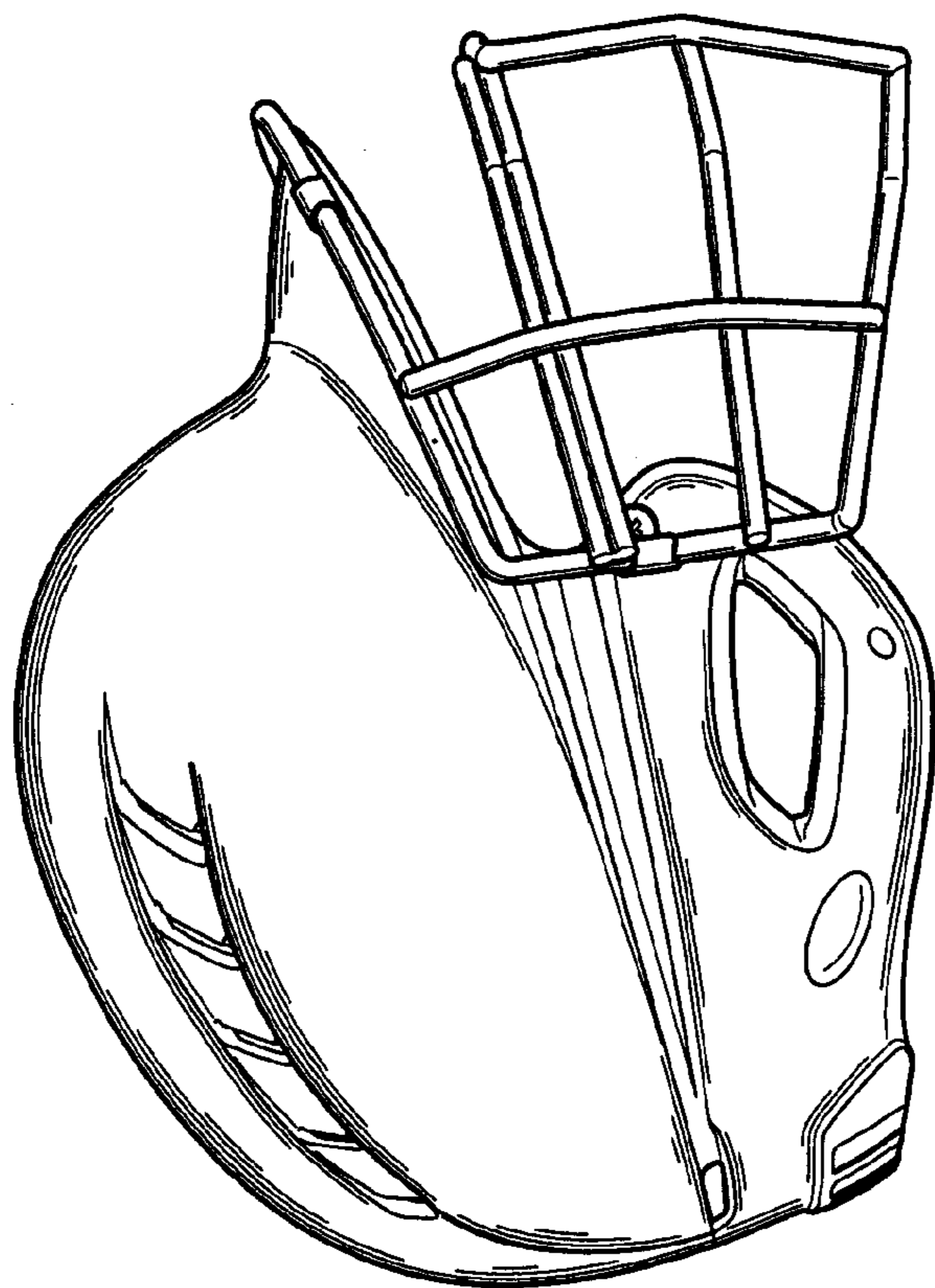

Fig. 5

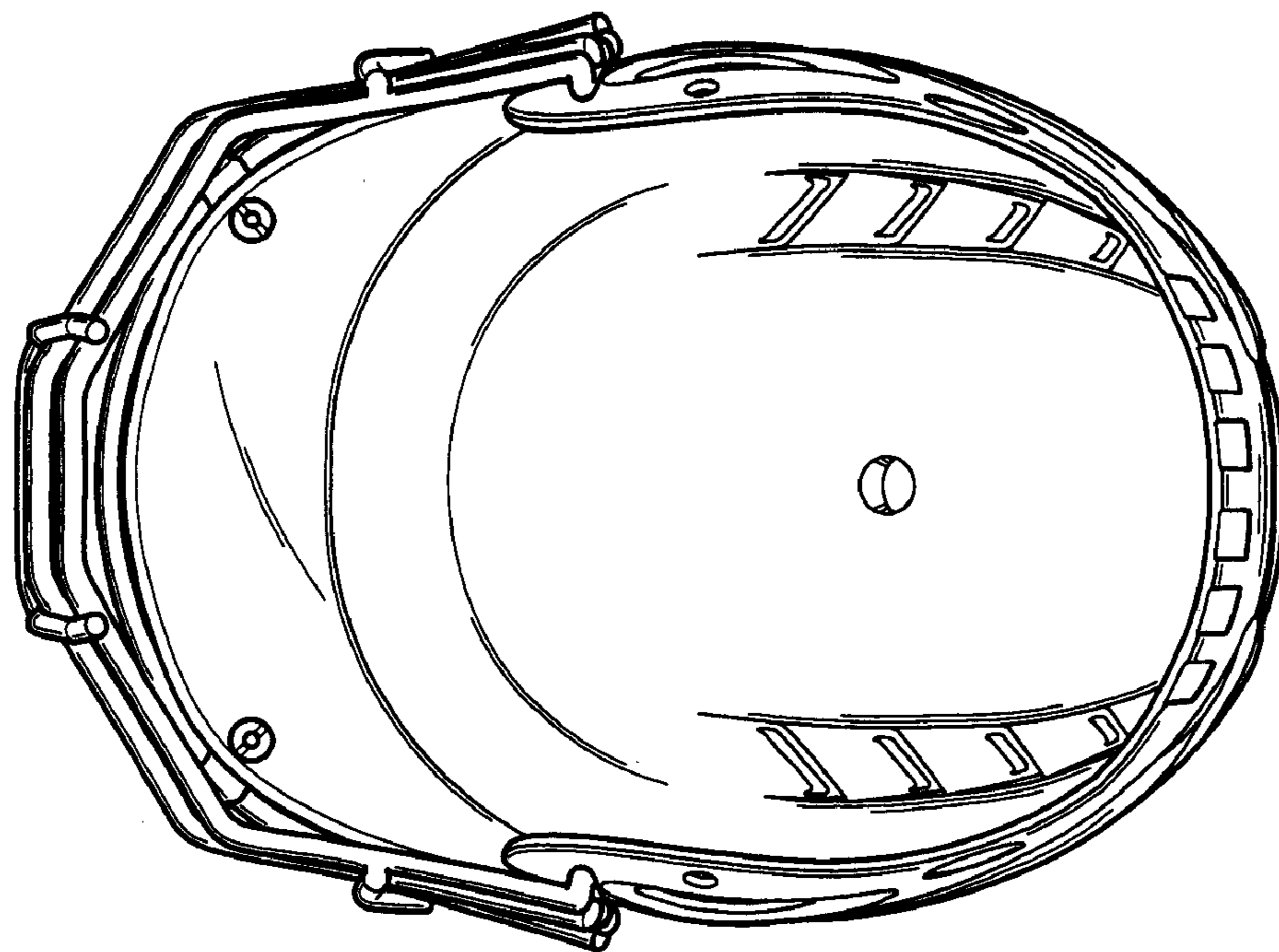

Fig. 8

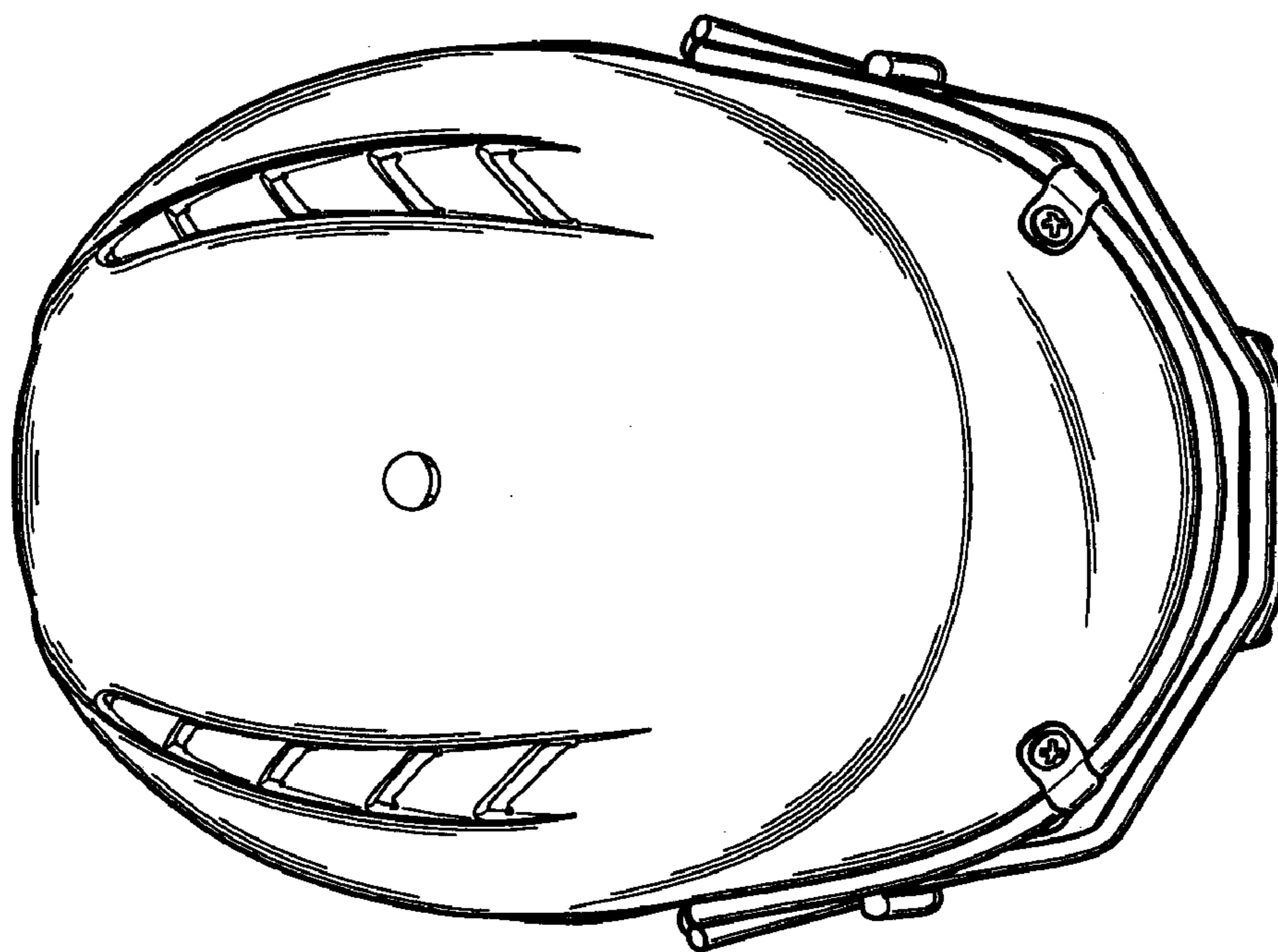

Fig. 7