



US00D575454S

(12) **United States Design Patent**
Keene et al.

(10) **Patent No.:** **US D575,454 S**
(45) **Date of Patent:** **** Aug. 19, 2008**

(54) **SHAVING BLADE UNIT**

(75) Inventors: **Andrew Russell Keene**, Stoneham, MA
(US); **Stephen Leonard Rawle**,
Newbury (GB)

(73) Assignee: **The Gillette Company**, Boston, MA
(US)

(**) Term: **14 Years**

(21) Appl. No.: **29/285,486**

(22) Filed: **Mar. 30, 2007**

(51) **LOC (8) Cl.** **28-03**

(52) **U.S. Cl.** **D28/47**

(58) **Field of Classification Search** D28/44-54;
30/30, 32, 34.05, 34.1, 34.2, 41-41.9, 44,
30/45, 47-51, 57, 58, 526, 527, 532, 533,
30/537-540, 346.5, 346.51-346.61
See application file for complete search history.

(56) **References Cited**

U.S. PATENT DOCUMENTS

D415,315 S 10/1999 Swanson et al.
D524,986 S * 7/2006 Prudden, Jr. D28/47
D533,684 S 12/2006 Gray et al.
D550,400 S * 9/2007 Orloff et al. D28/47

D556,378 S * 11/2007 Watson et al. D28/47
2005/0188539 A1 9/2005 Prudden et al.
2005/0198841 A1 9/2005 Worrick
2006/0080837 A1* 4/2006 Johnson et al. 30/50
2007/0062044 A1* 3/2007 Walker et al. 30/50

* cited by examiner

Primary Examiner—Jennifer Rivard

(74) *Attorney, Agent, or Firm*—Brion A. Berman; Kevin C. Johnson

(57) **CLAIM**

The ornamental design for a shaving blade unit, as shown and described.

DESCRIPTION

FIG. 1 is a top perspective view of a shaving blade unit showing our new design;

FIG. 2 is a top plan view thereof;

FIG. 3 is a left side elevational view, the right side elevational view being a mirror image thereof;

FIG. 4 is a bottom plan view thereof;

FIG. 5 is a front elevation view thereof; and,

FIG. 6 is a rear elevation view thereof.

1 Claim, 6 Drawing Sheets

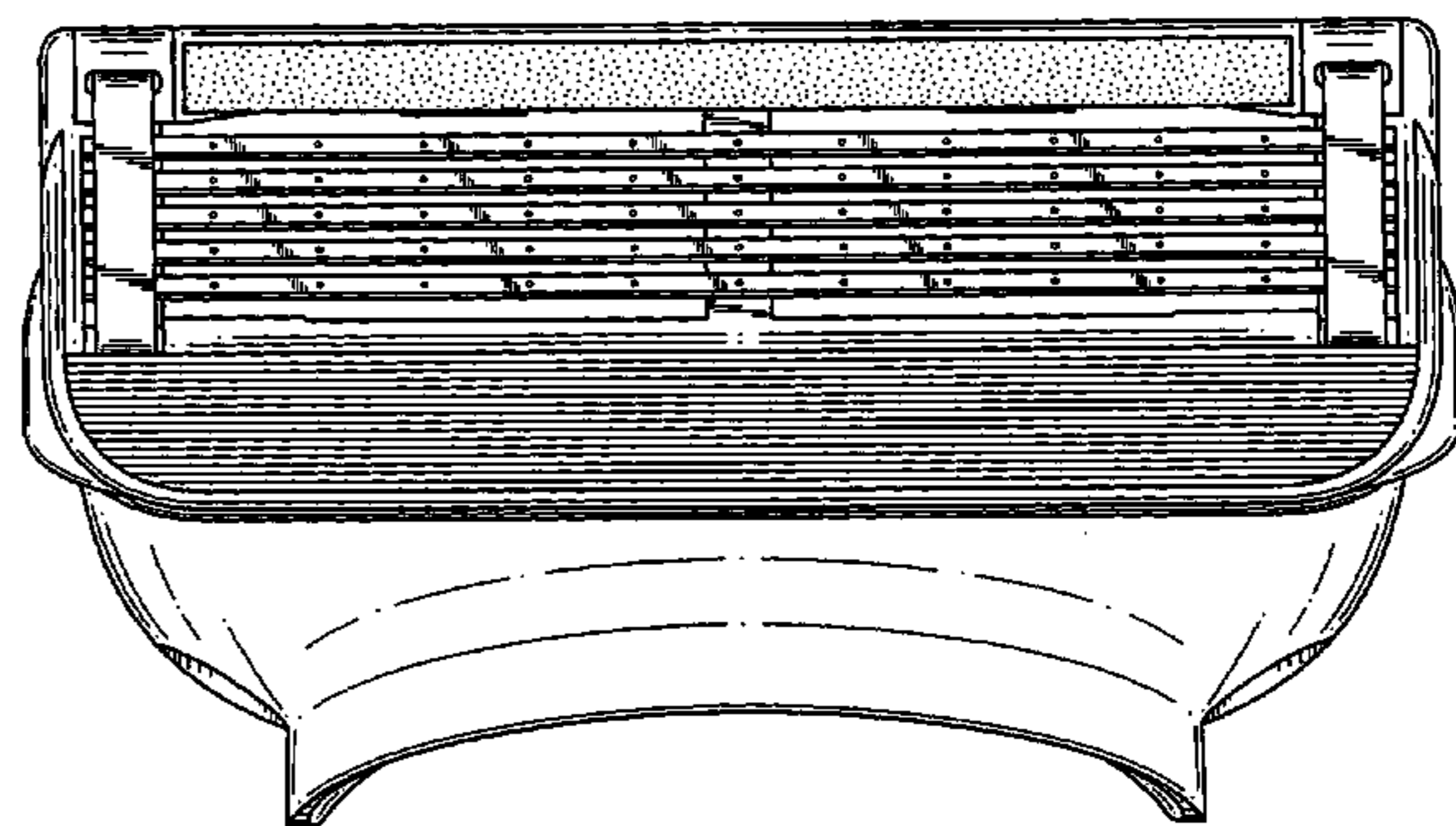
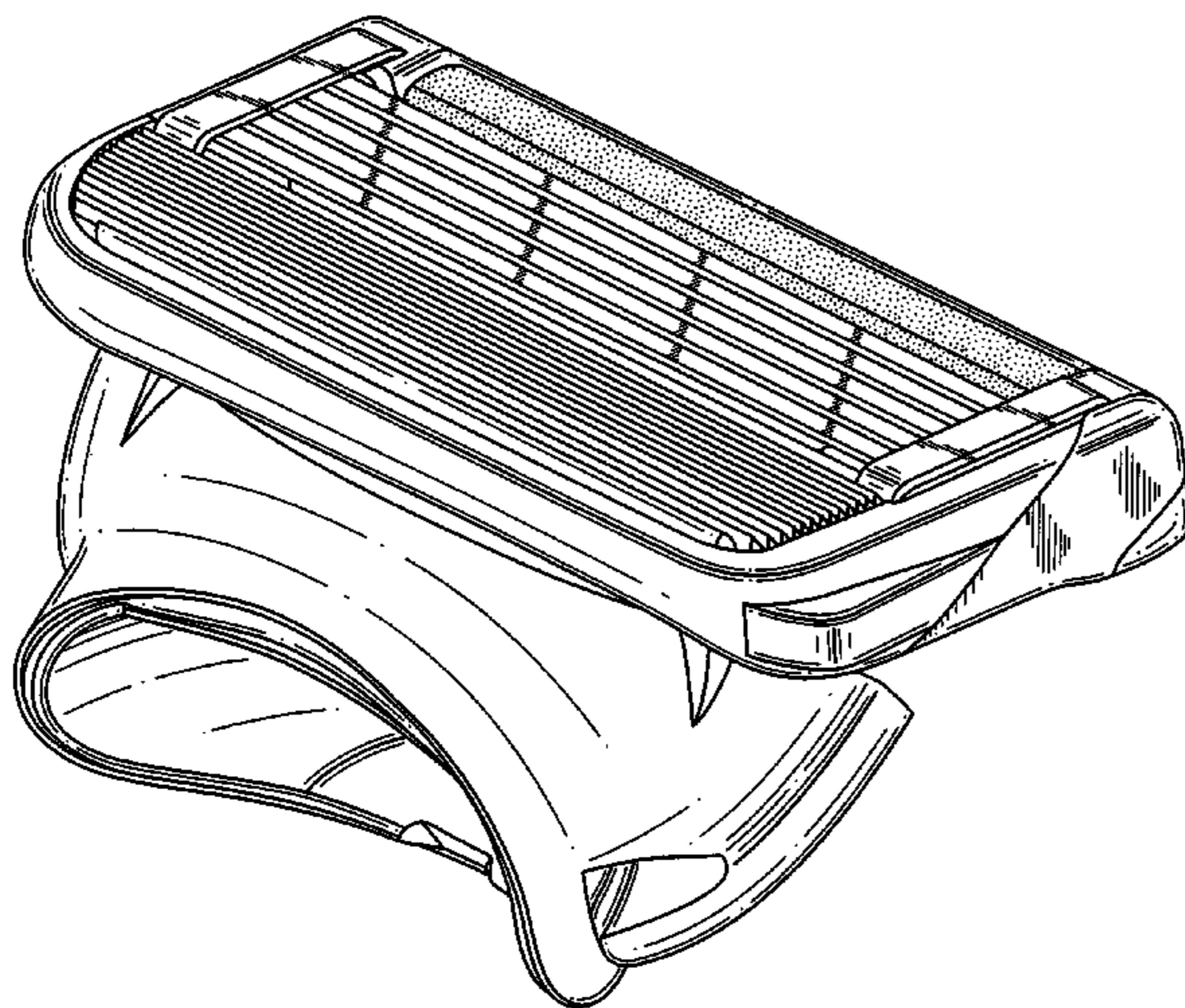

FIG. 1

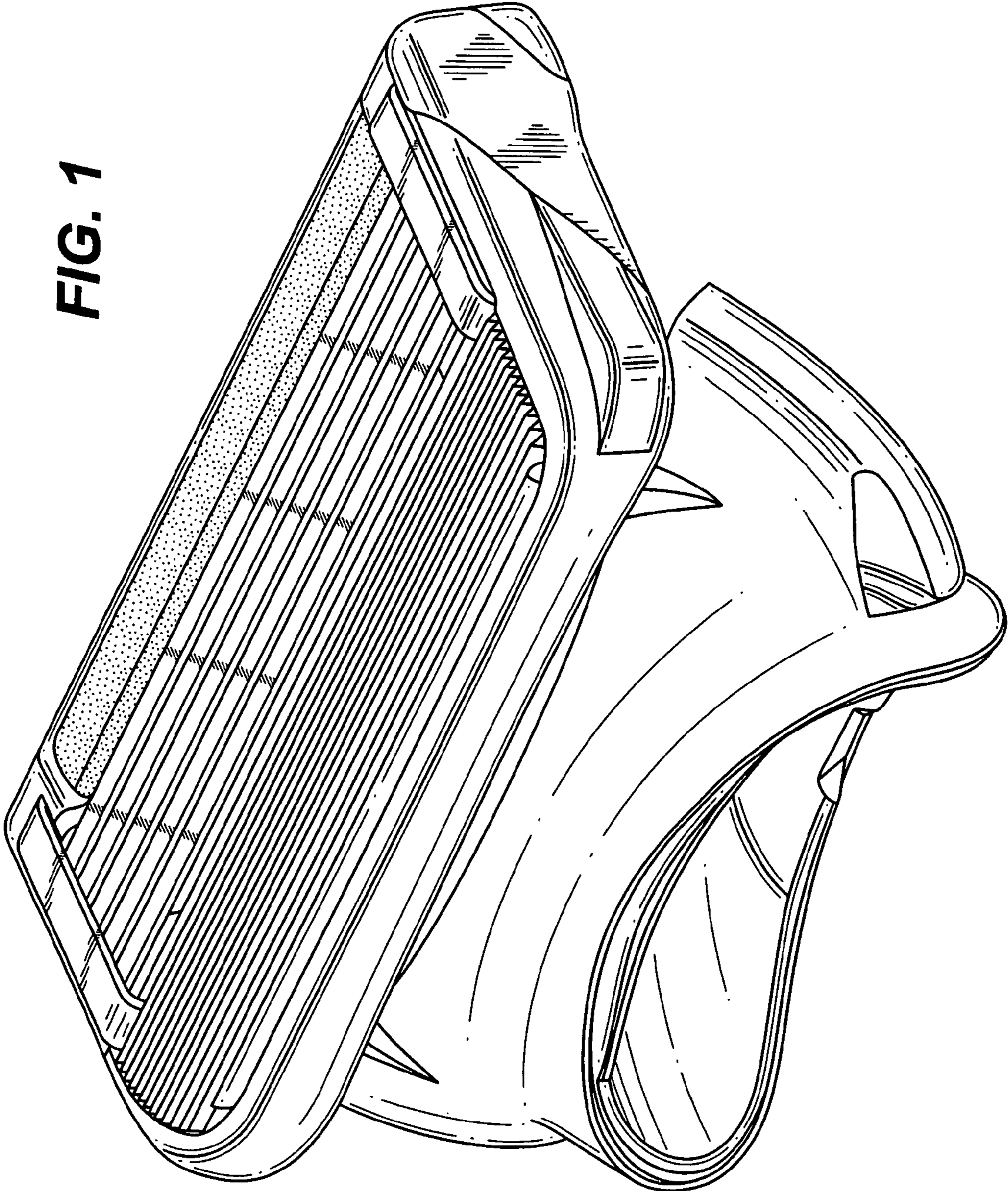

FIG. 2

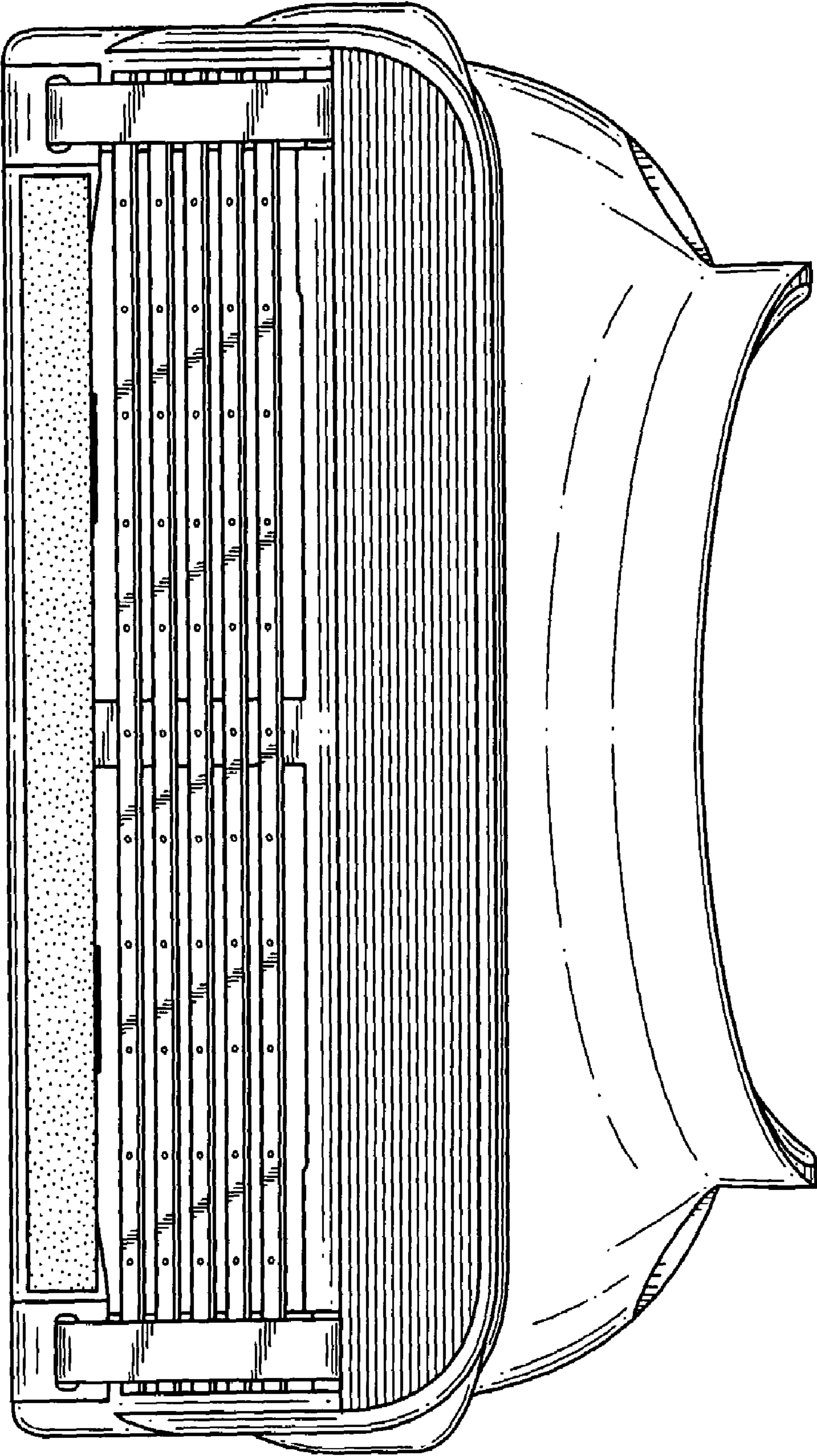

FIG. 3

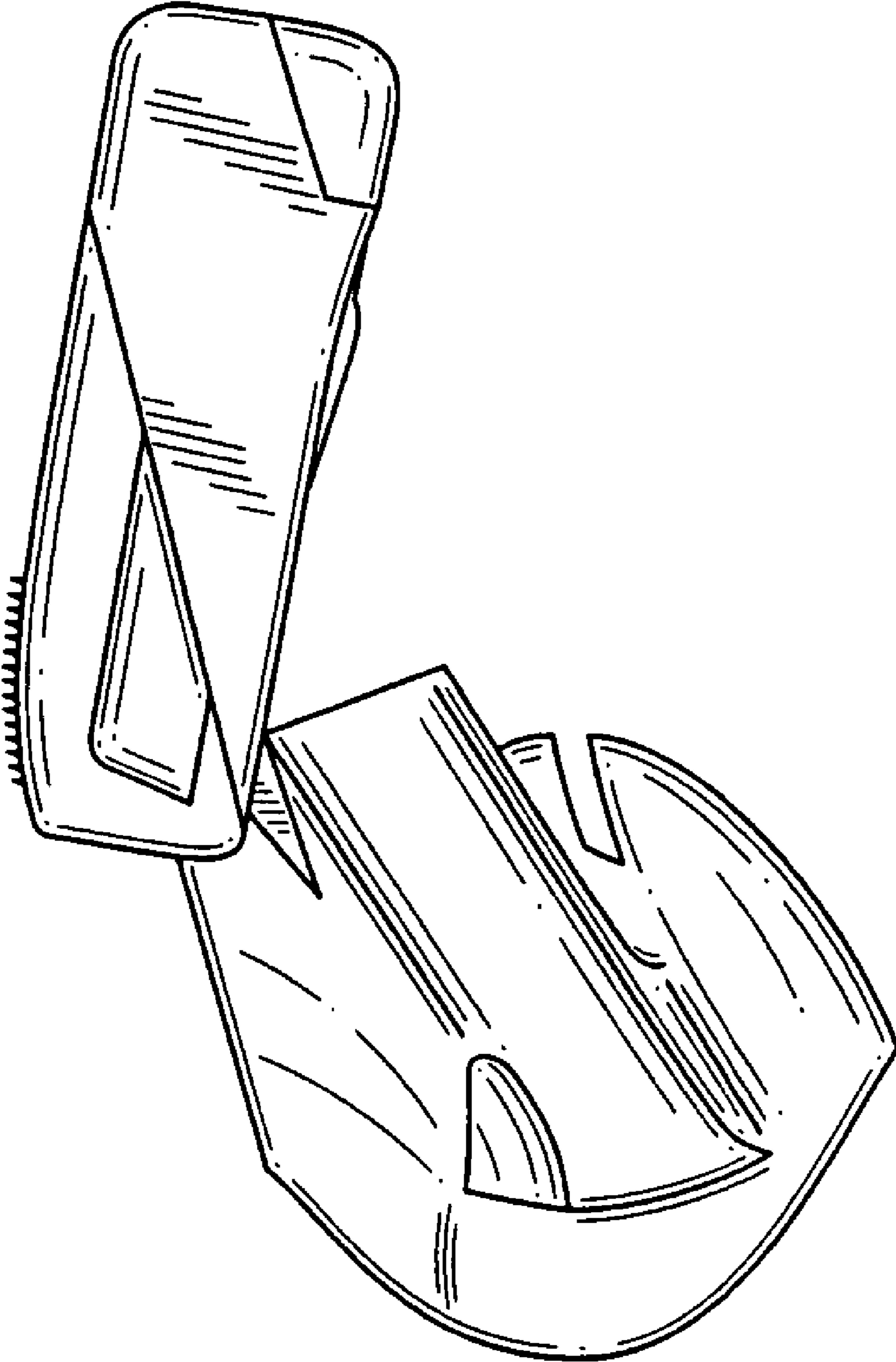

FIG. 4

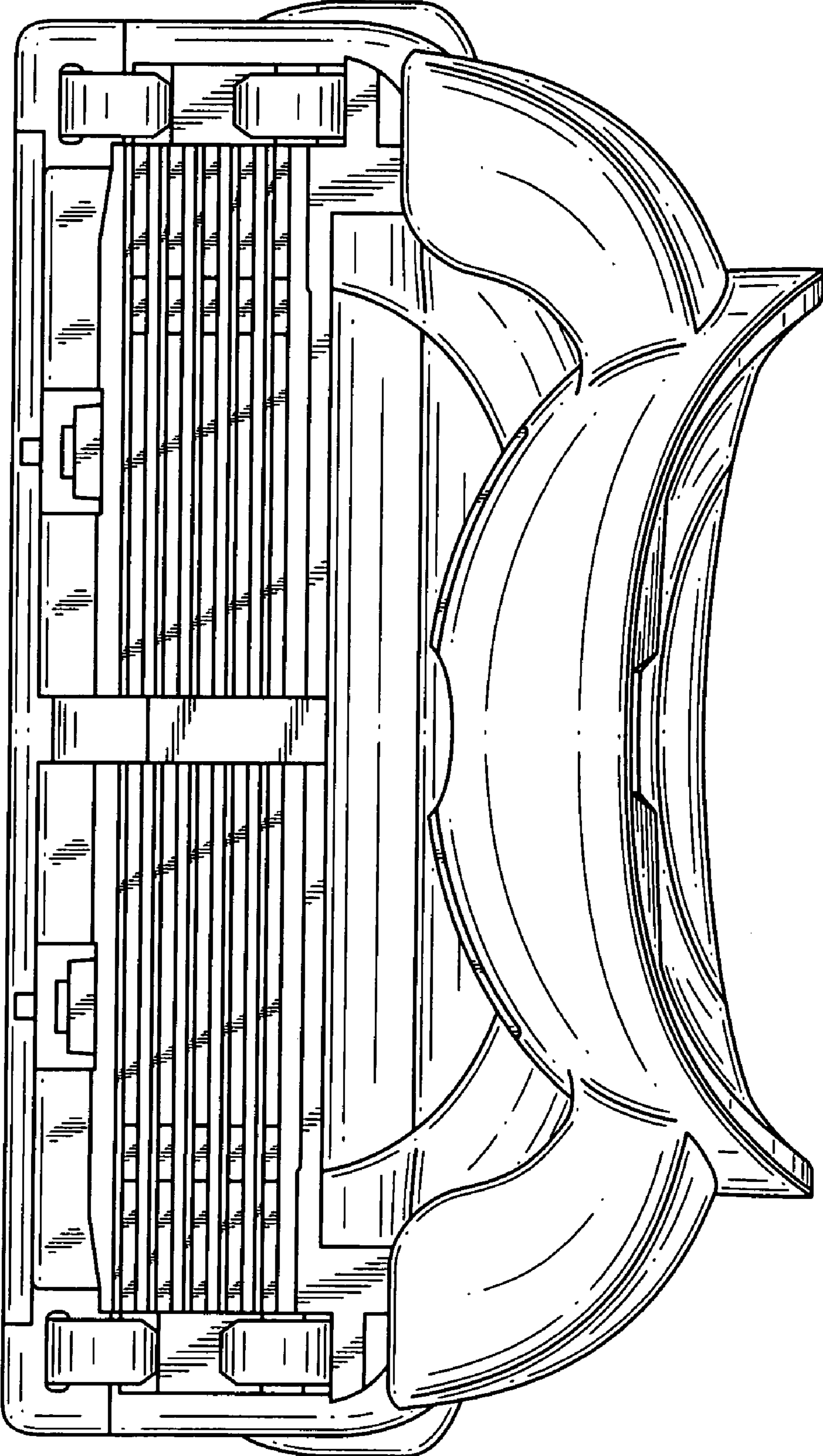

FIG. 5

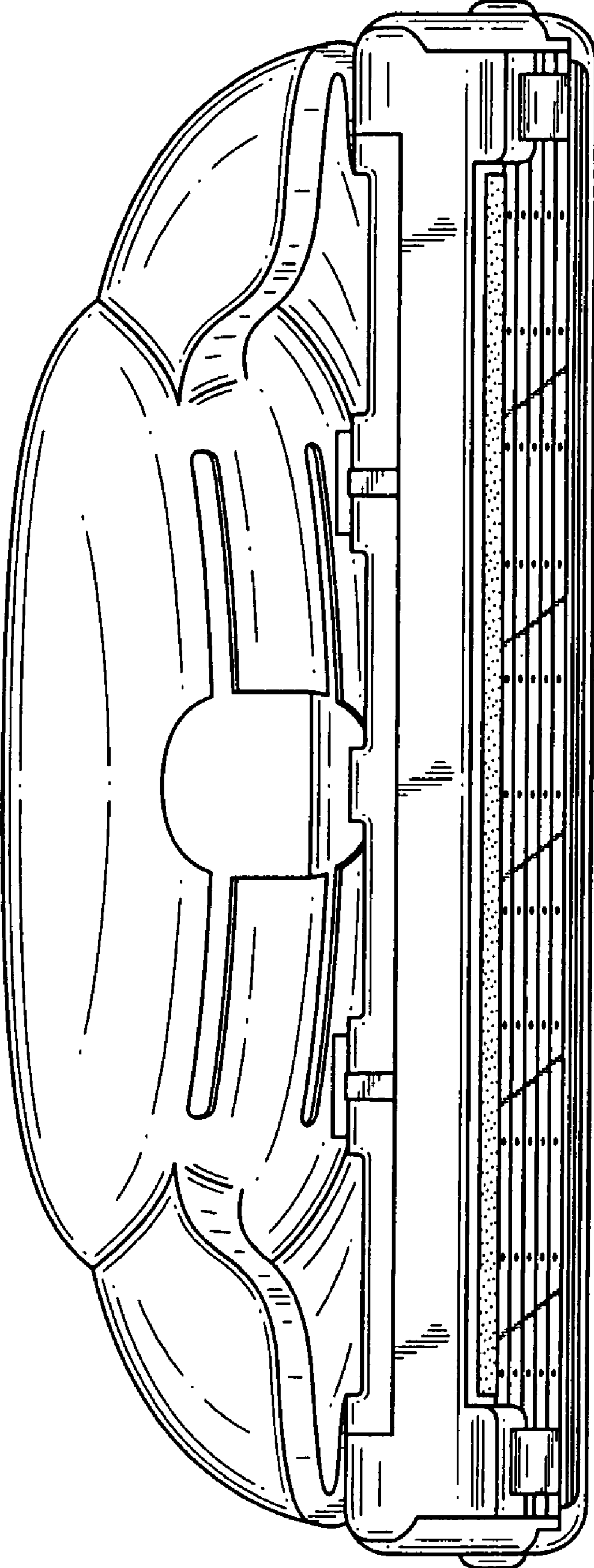

FIG. 6

