



US00D575450S

(12) **United States Design Patent**
Jones et al.

(10) **Patent No.:** **US D575,450 S**
(45) **Date of Patent:** **** Aug. 19, 2008**

- (54) **CONTAINER FOR CIGARETTES**
- (76) Inventors: **Wesley Steven Jones**, 1025 Falling Leaf La., Winston-Salem, NC (US) 27107; **Pankaj Patel**, 3761 Squirewood Dr., Clemmons, NC (US) 27012; **William Paul Scott**, 8217 Kildare St., Clemmons, NC (US) 27012
- (**) Term: **14 Years**
- (21) Appl. No.: **29/279,421**
- (22) Filed: **Apr. 30, 2007**
- (51) **LOC (8) Cl.** **27-06**
- (52) **U.S. Cl.** **D27/189**
- (58) **Field of Classification Search** 206/236–241, 206/249–251, 254–259, 261–275; D27/185–192; 229/160.1; D9/430, 432; 220/4.5
See application file for complete search history.

6,363,691	B1	4/2002	Flaherty	
D463,066	S *	9/2002	Draghetti	D27/189
6,612,429	B2	9/2003	Dennen	
6,779,658	B2 *	8/2004	Polloni et al.	206/268
6,837,369	B2	1/2005	Amos	
6,874,623	B2	4/2005	Bray	
6,889,827	B2	5/2005	Stringfield	
6,932,219	B2	8/2005	Chacko et al.	
D509,623	S	9/2005	Mitten et al.	
D523,171	S	6/2006	Mitten et al.	
D523,990	S	6/2006	Mitten et al.	
7,100,763	B2	9/2006	Draghetti	
7,100,764	B2	9/2006	Focke	
D542,466	S	5/2007	Polloni et al.	
7,213,704	B2	5/2007	Li Vigni et al.	
D555,284	S *	11/2007	Fath	D27/189
2002/0190110	A1 *	12/2002	Polloni et al.	206/268
2004/0055909	A1 *	3/2004	Gamberi et al.	206/271
2005/0023158	A1	2/2005	Mitten et al.	
2005/0150786	A1	7/2005	Mitten et al.	
2006/0091026	A1	5/2006	Mitten et al.	

* cited by examiner

(56) **References Cited**
U.S. PATENT DOCUMENTS

136,984	A *	3/1873	Felgner	206/242
580,447	A *	4/1897	Besuner	229/4.5
874,337	A *	12/1907	Helm	206/265
2,068,763	A *	1/1937	Powell	229/185
3,007,623	A	11/1961	Clemens	
3,127,083	A	3/1964	Guyer	
3,148,768	A	9/1964	Gatto	
3,226,010	A	12/1965	Rogers, Jr.	
3,874,581	A	4/1975	Fox et al.	
3,944,066	A	3/1976	Niepmann	
4,050,622	A	9/1977	Shimada et al.	
4,294,353	A	10/1981	Focke et al.	
D279,507	S	7/1985	Schechter et al.	
4,753,383	A	6/1988	Focke et al.	
4,784,261	A	11/1988	Kutchin	
4,836,378	A	6/1989	Lephardt	
4,852,734	A	8/1989	Allen et al.	
4,923,059	A	5/1990	Evers et al.	
5,097,948	A	3/1992	Campbell	
5,143,282	A	9/1992	Pham	
5,392,905	A	2/1995	Focke et al.	

Primary Examiner—Jennifer Rivard
(74) *Attorney, Agent, or Firm*—Brinks Hofer Gilson & Lione

(57) **CLAIM**

We claim the ornamental design for a container for cigarettes, as shown and described.

DESCRIPTION

FIG. 1 is a top perspective view of a first embodiment of a container for cigarettes of the present invention in a folded configuration;

FIG. 2 is a left side elevation view thereof, a right side elevation view thereof being a mirror image of the left side elevation view;

FIG. 3 is a front elevation view thereof, a rear elevation view thereof being a mirror image of the front elevation view;

FIG. 4 is a top plan view thereof, a bottom plan view thereof being a mirror image of the top plan view;

FIG. 5 is a top perspective view of the first embodiment of the container for cigarettes in an unfolded configuration;

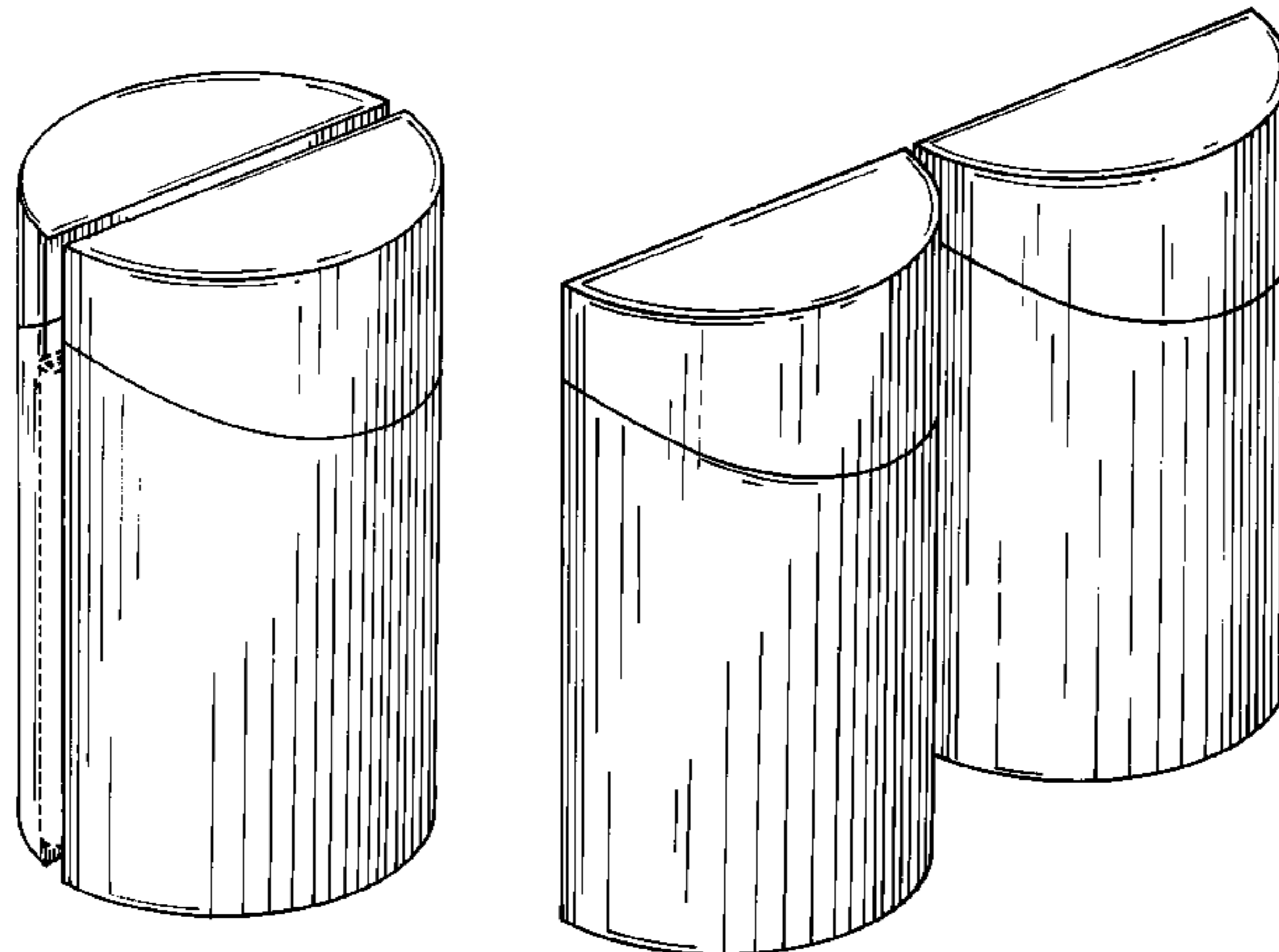

FIG. 6 is a left elevation view thereof, a right side elevation view thereof being a mirror image of the left side elevation view;

FIG. 7 is a top plan view thereof, a bottom plan view thereof being a mirror image of the top plan view;

FIG. 8 is a rear elevation view thereof;

FIG. 9 is a top perspective view of the first embodiment of the container for cigarettes in an unfolded configuration, with a lid region of one container portion shown in an open configuration;

FIG. 10 is a top perspective view of a second embodiment of the container for cigarettes of the present invention;

FIG. 11 is a right side elevation view thereof, a left side elevation view thereof being a mirror image of the right side elevation view;

FIG. 12 is a front elevation view thereof;

FIG. 13 is a rear elevation view thereof;

FIG. 14 is a top plan view thereof, a bottom plan view thereof being a mirror image of the top plan view;

FIG. 15 is a top perspective view of the second embodiment of the container for cigarettes, with a lid region thereof shown in an open configuration;

FIG. 16 is a top perspective view of a third embodiment of a container for cigarettes of the present invention in a folded configuration;

FIG. 17 is a left side elevation view thereof, a right side elevation view thereof being a mirror image of the left side elevation view;

FIG. 18 is a front elevation view thereof, a rear elevation view thereof being a mirror image of the front elevation view;

FIG. 19 is a top plan view thereof, a bottom plan view thereof being a mirror image of the top plan view;

FIG. 20 is a rear elevation view of the third embodiment of the container for cigarettes in an unfolded configuration, a top perspective view thereof being identical to the view of FIG. 5;

FIG. 21 is a left elevation view thereof, a right side elevation view thereof being a mirror image of the left side elevation view; and,

FIG. 22 is a top plan view thereof, a bottom plan view thereof being a mirror image of the top plan view.

The ornamental design which is claimed is shown in solid lines in the drawings. The broken lines immediately adjacent the shaded areas represent the bounds of the claim and all other broken lines are for illustrative purposes only. None of the broken lines form a part of the claimed design.

1 Claim, 15 Drawing Sheets

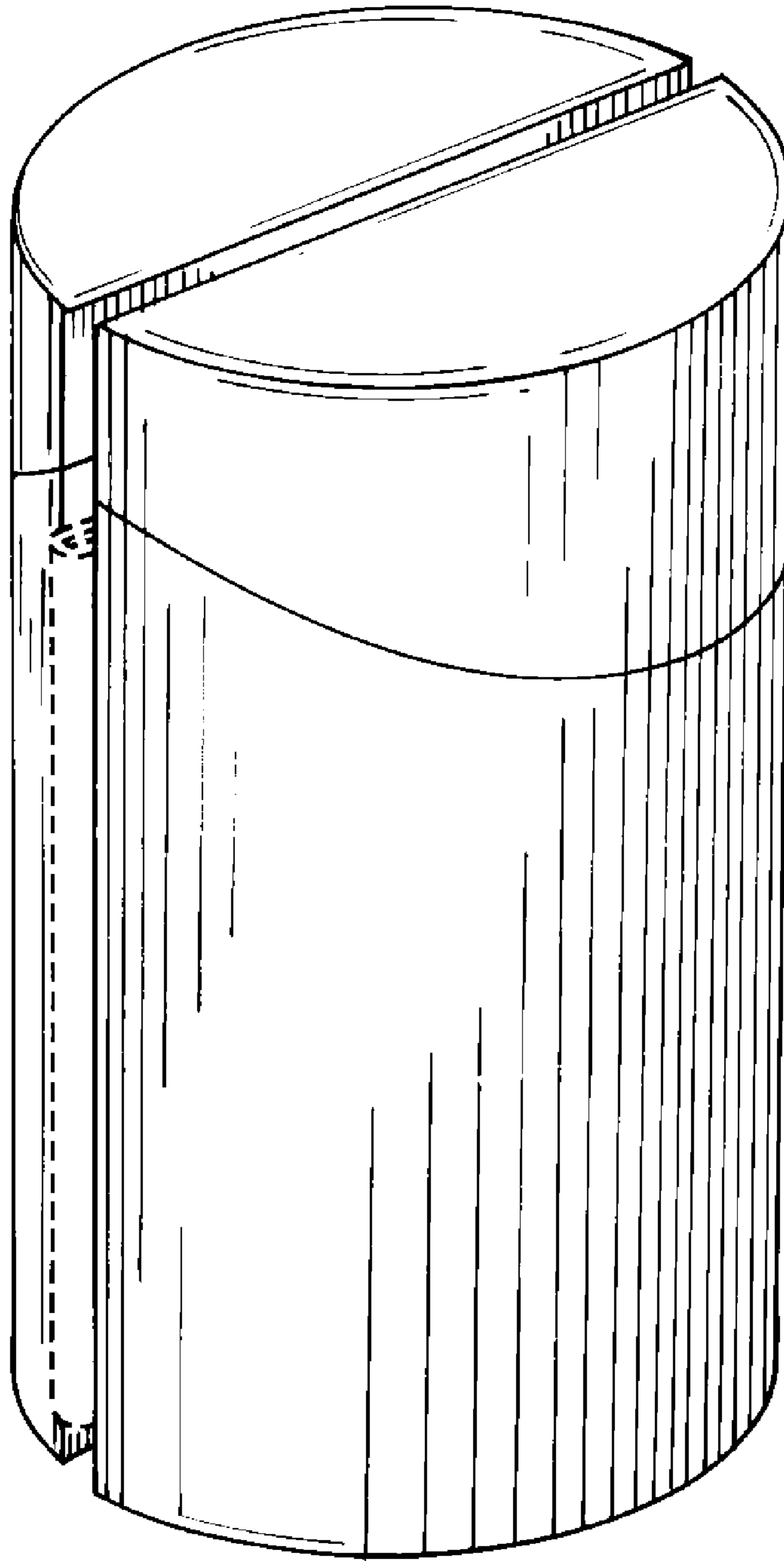

Fig. 1

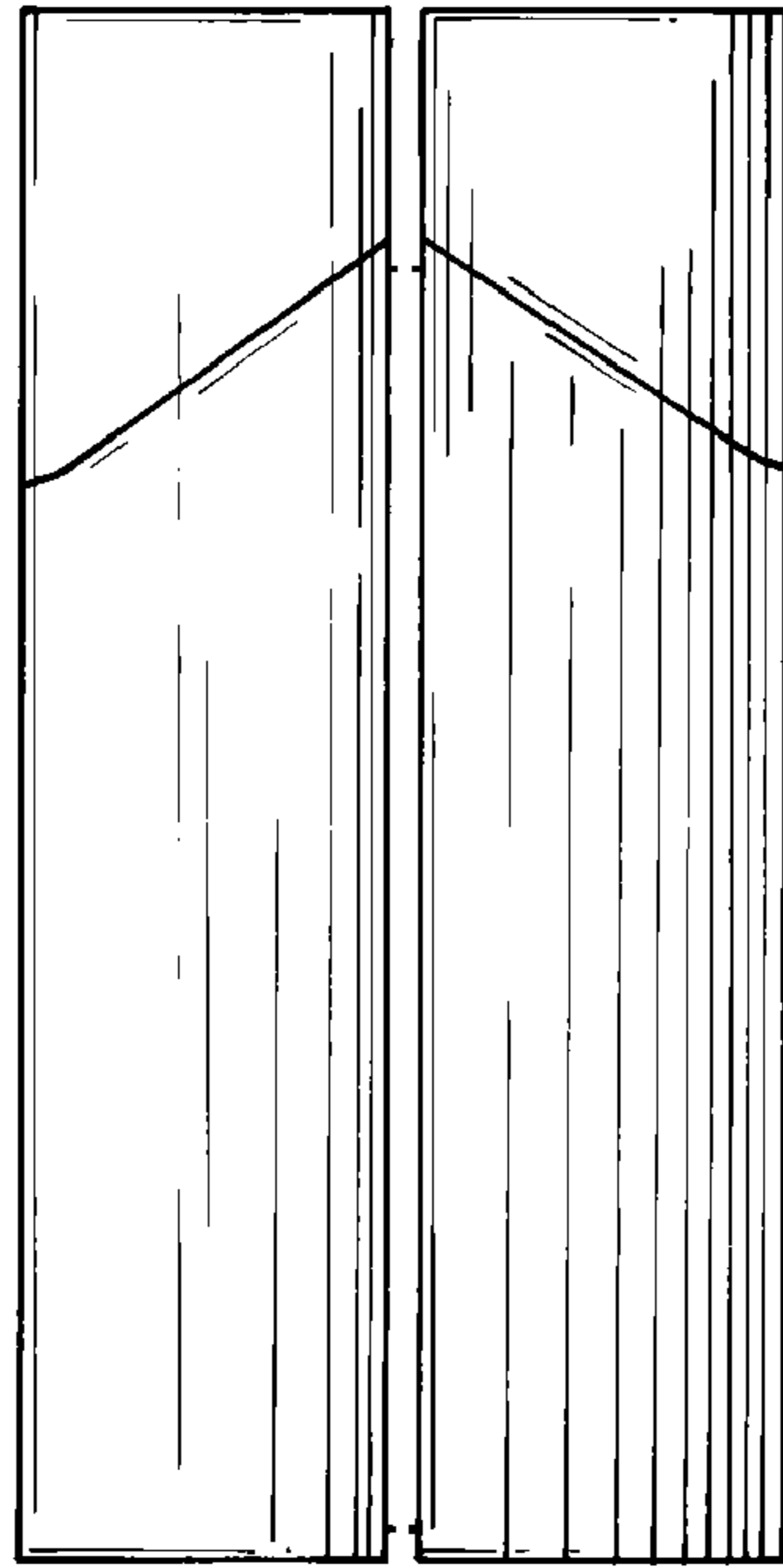

Fig. 2

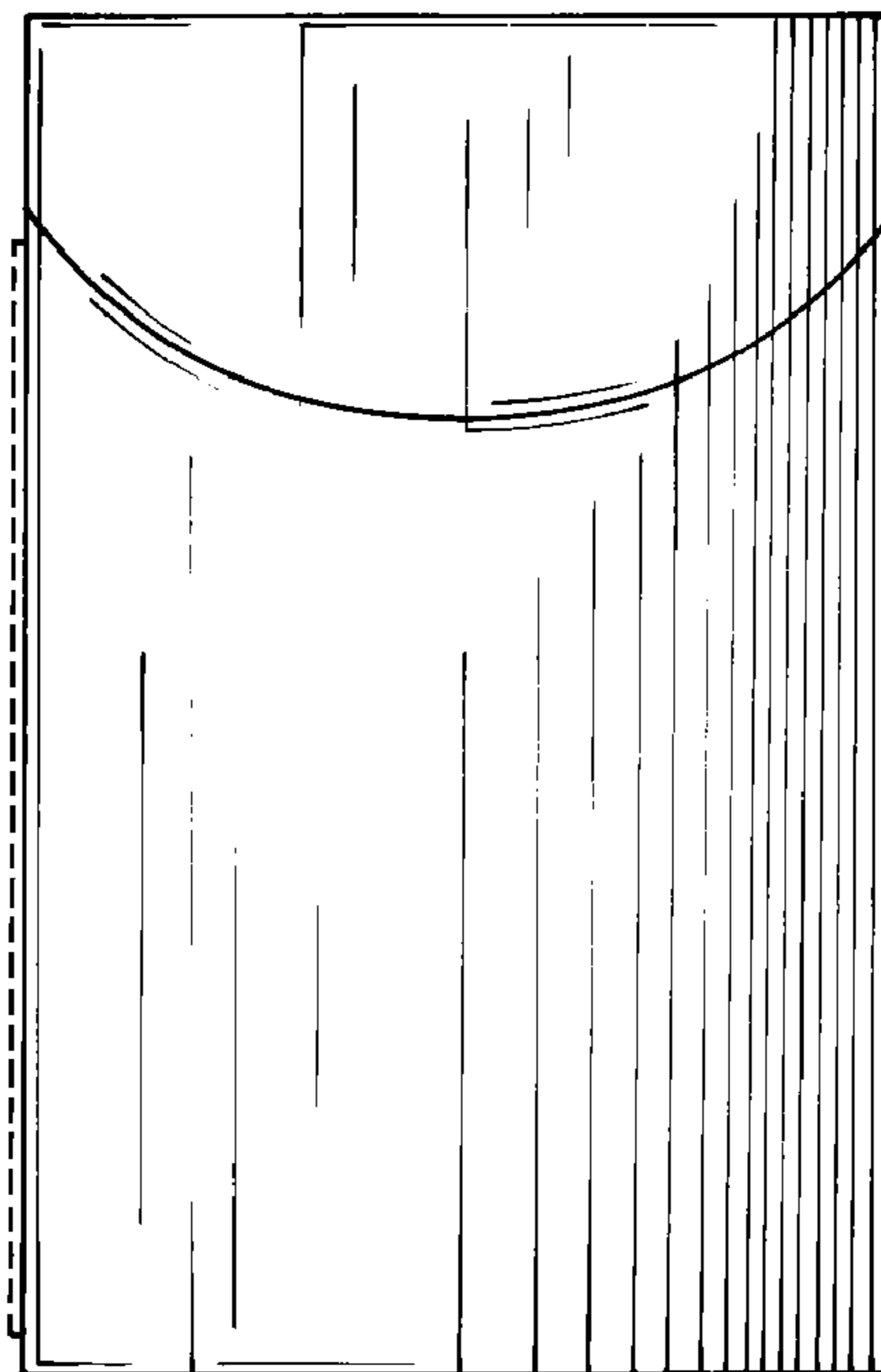

Fig. 3

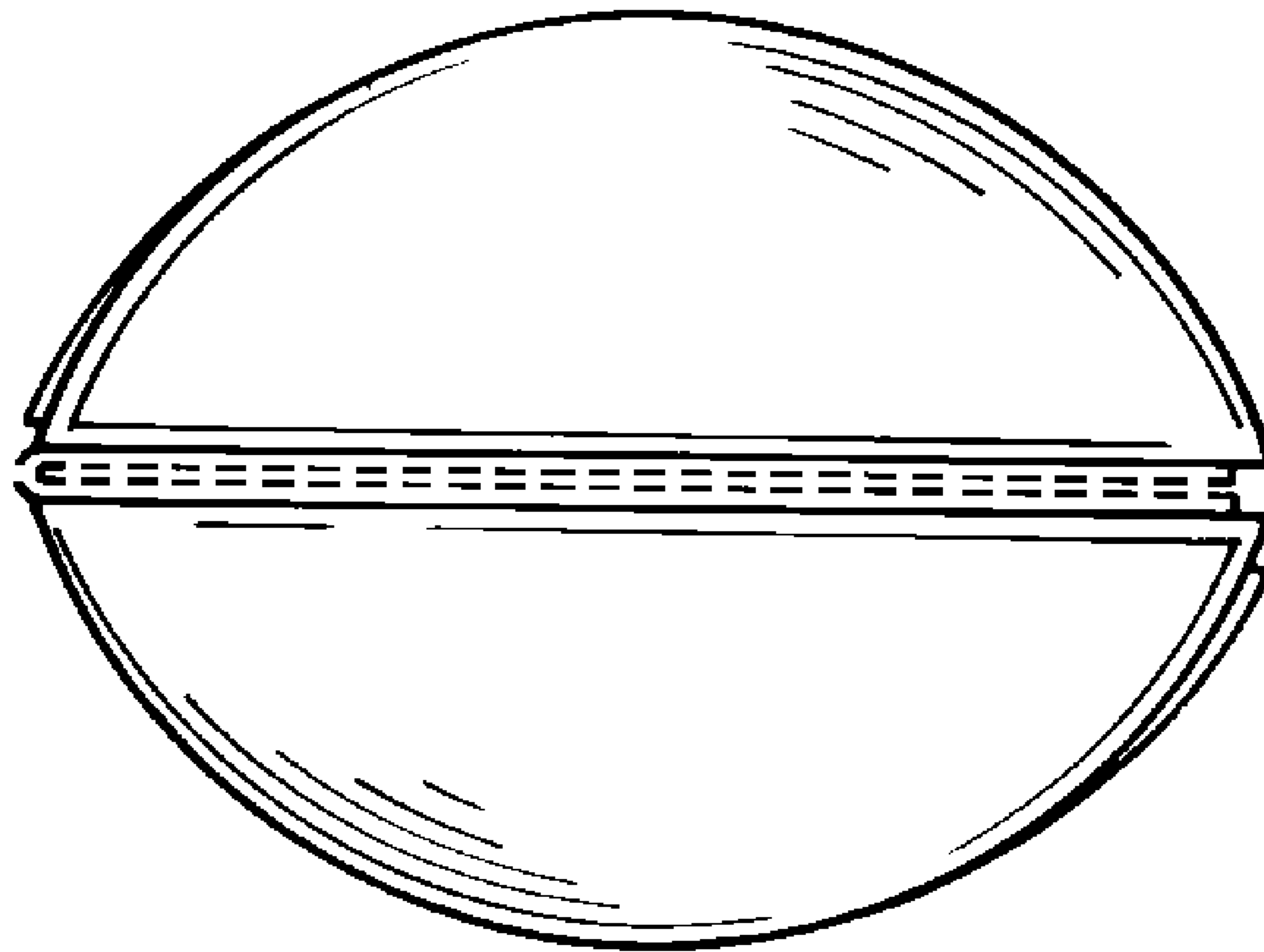

Fig. 4

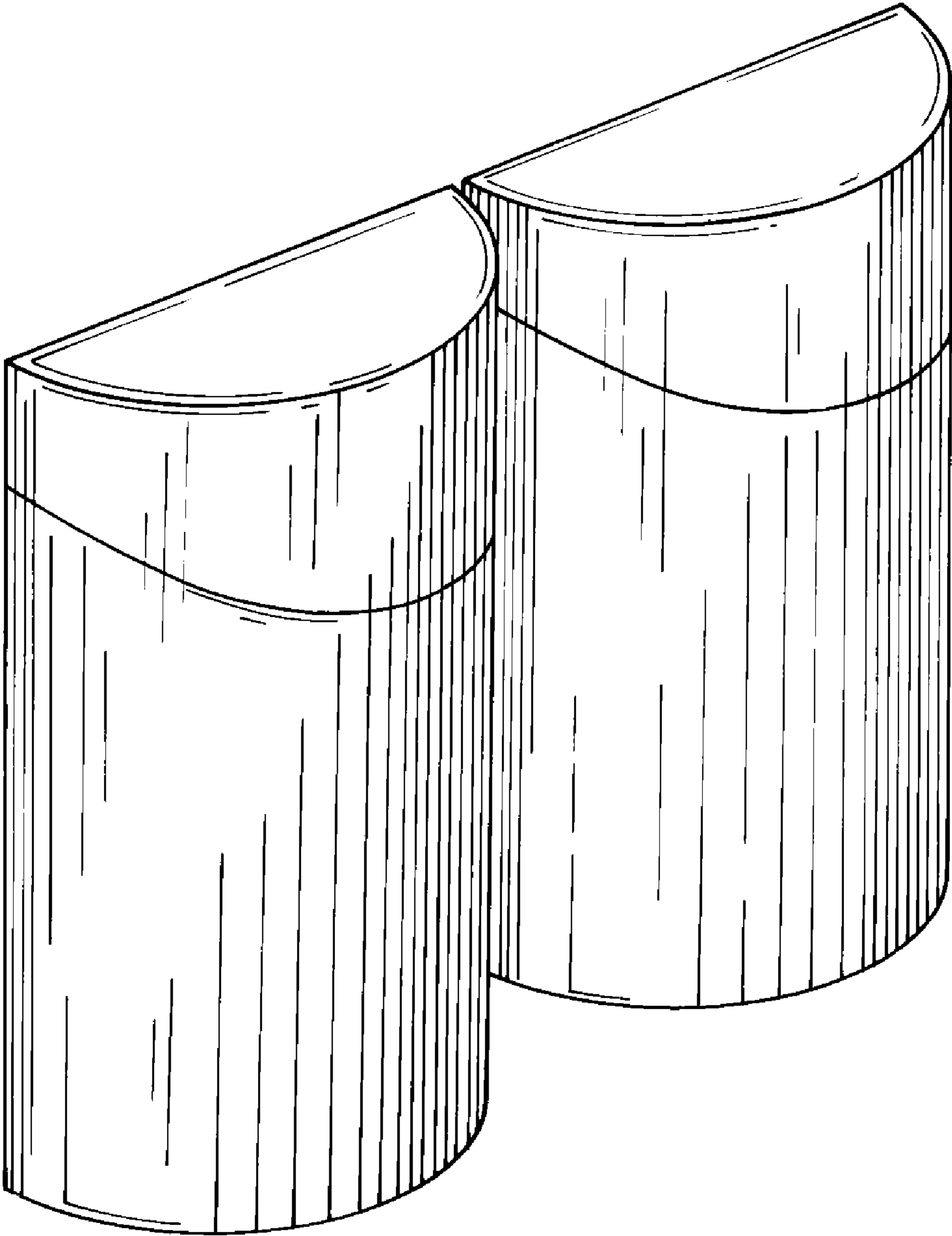

Fig. 5

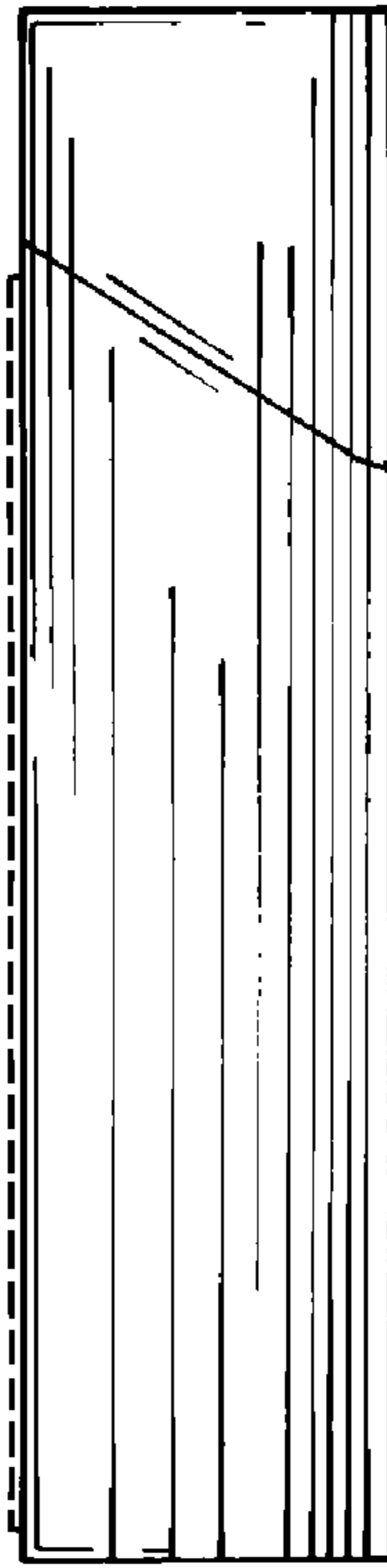

Fig. 6

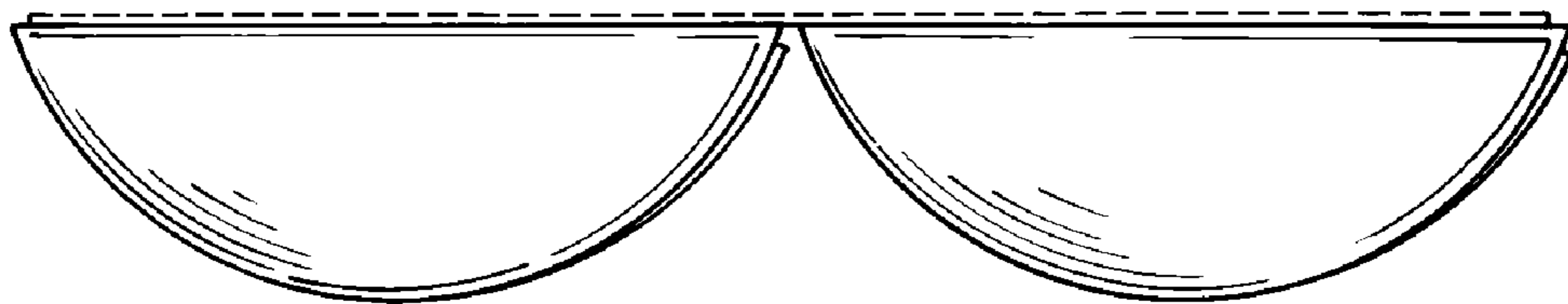

Fig. 7

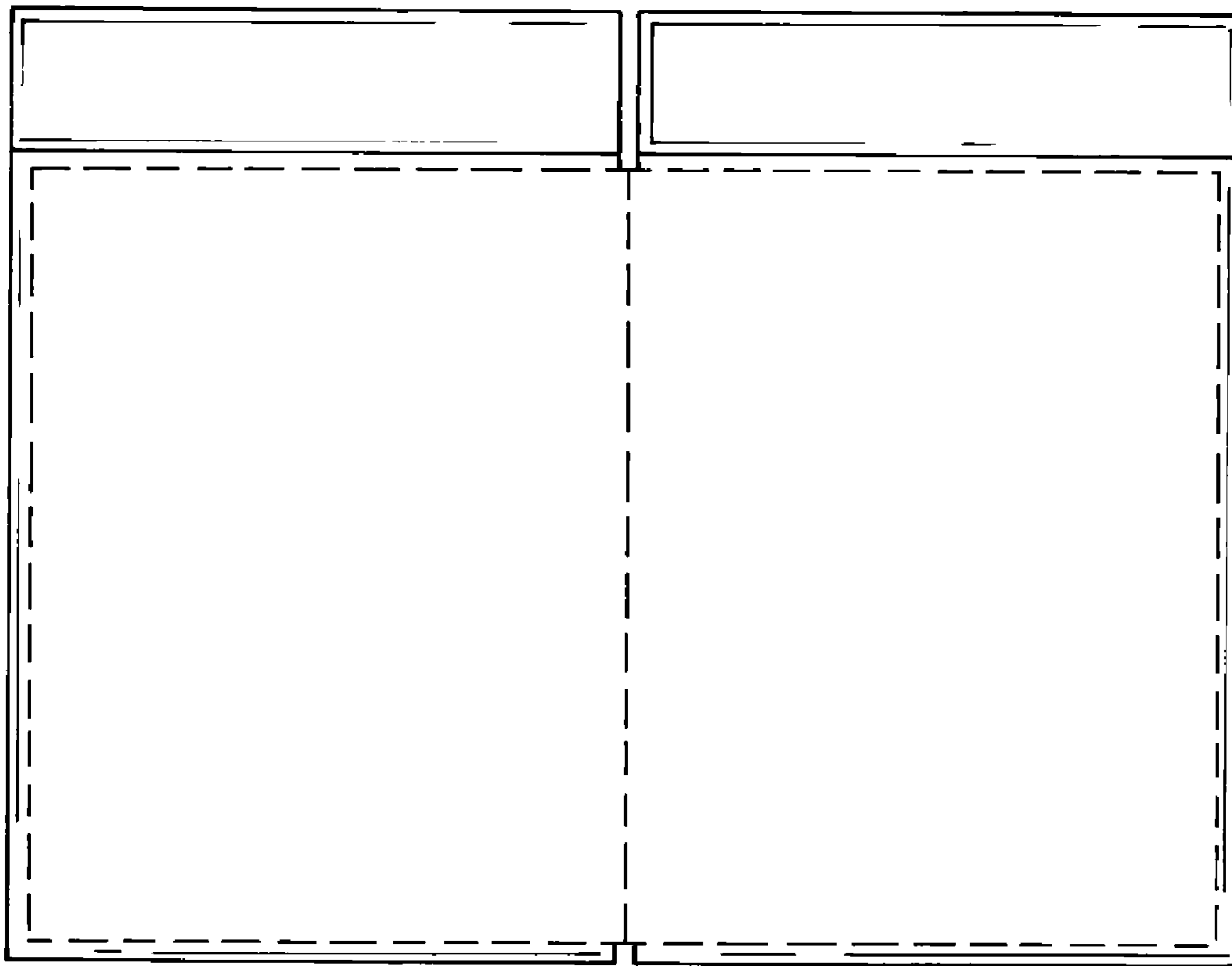

Fig. 8

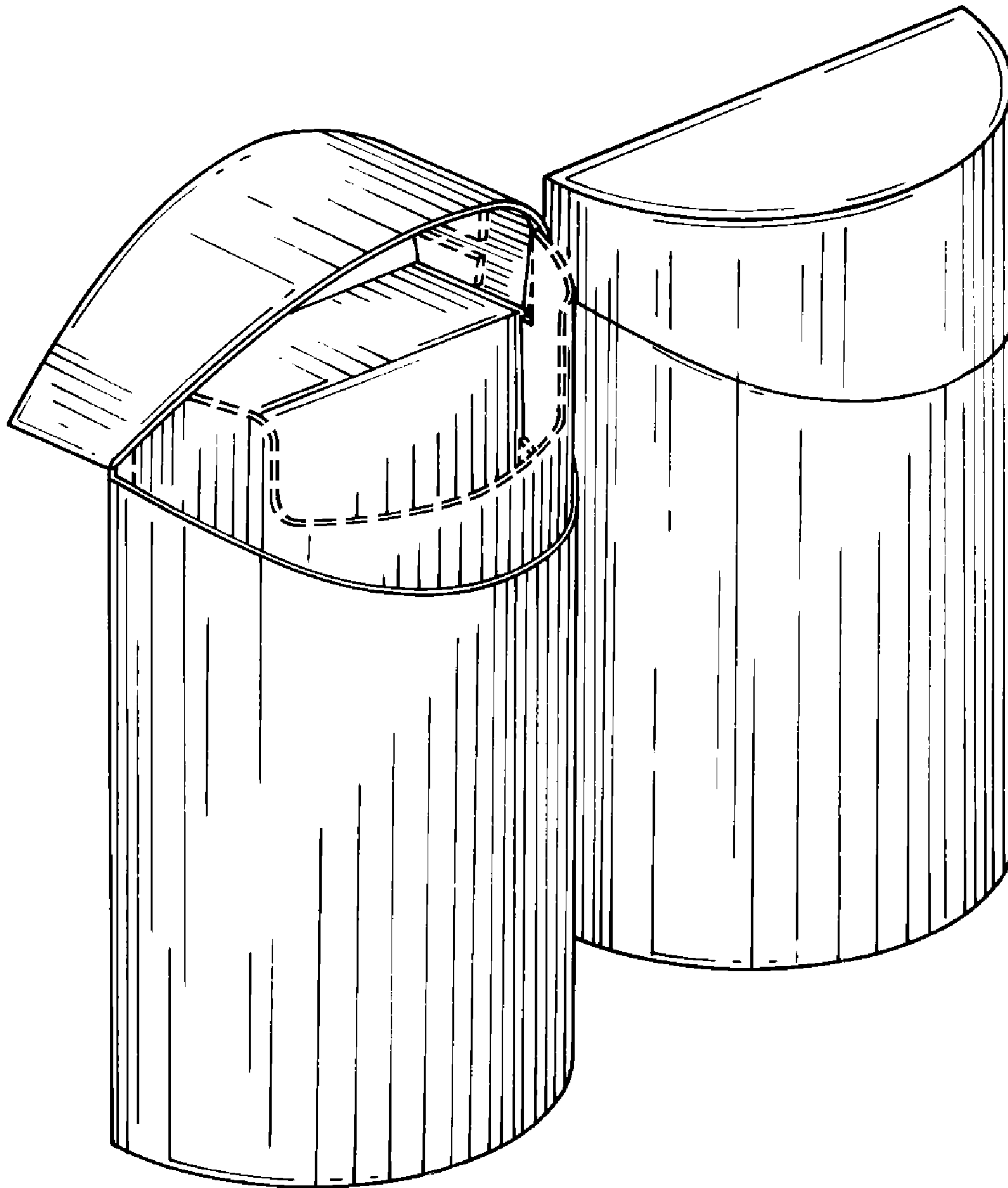

Fig. 9

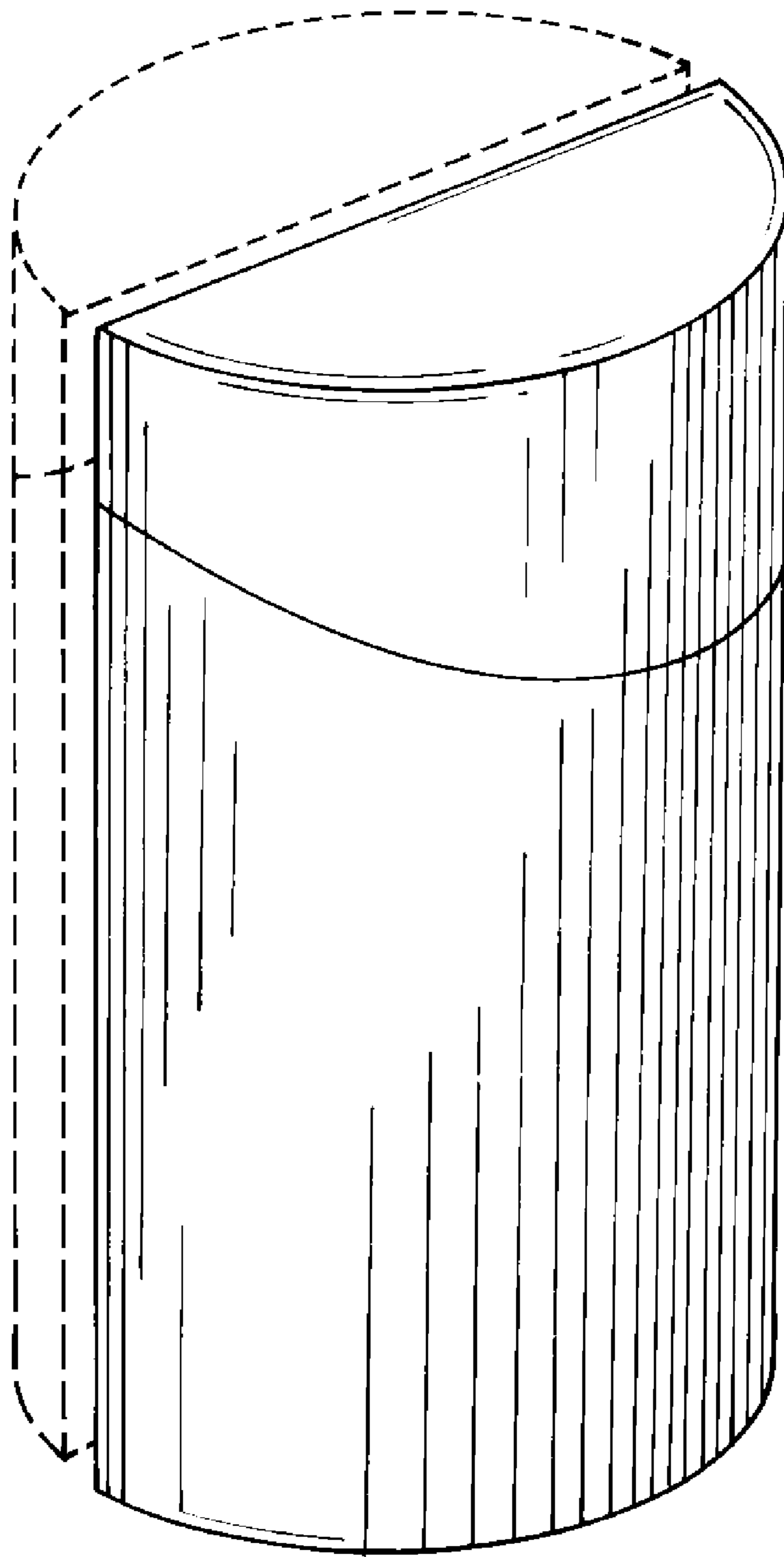

Fig. 10

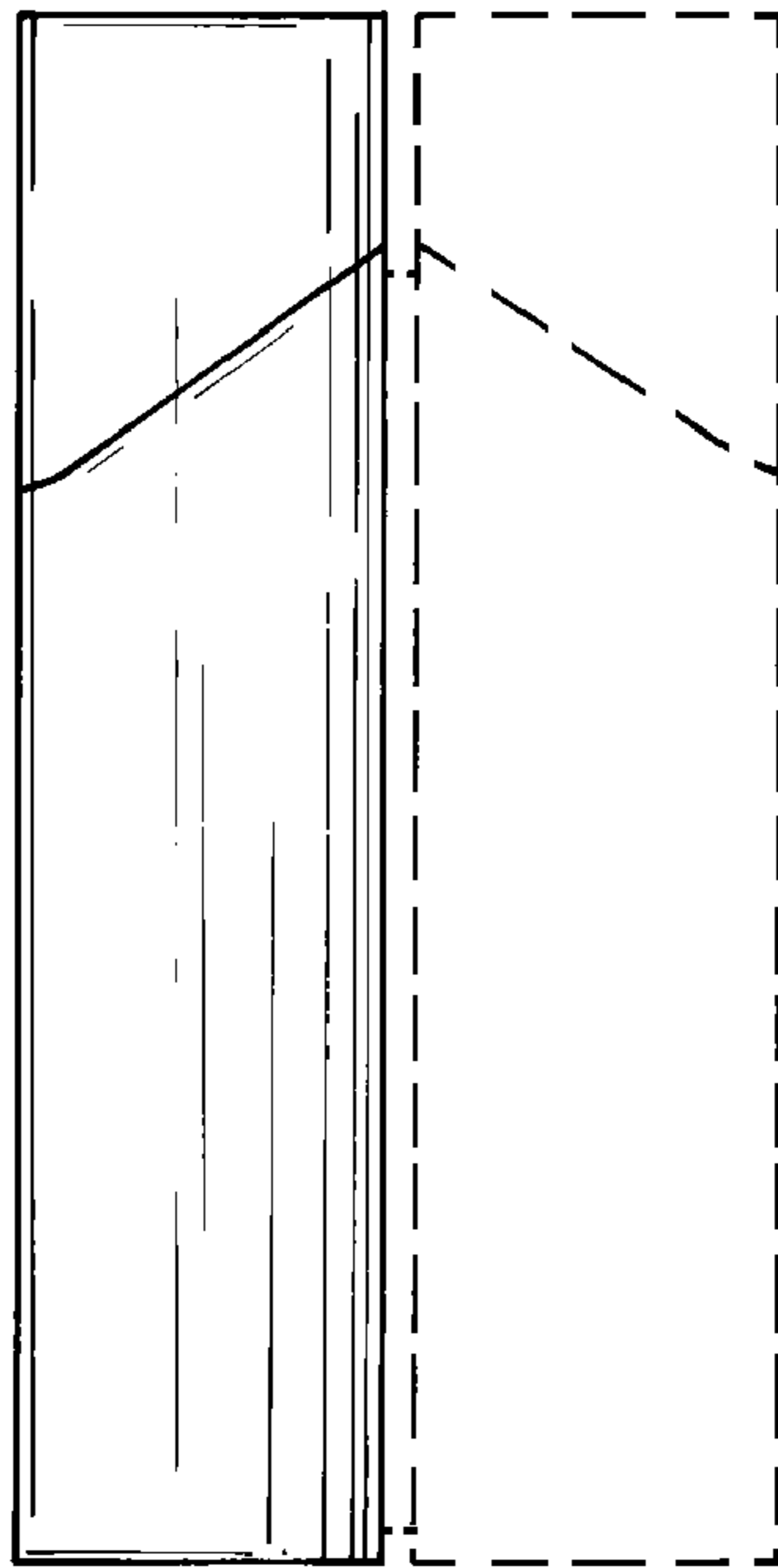

Fig. 11

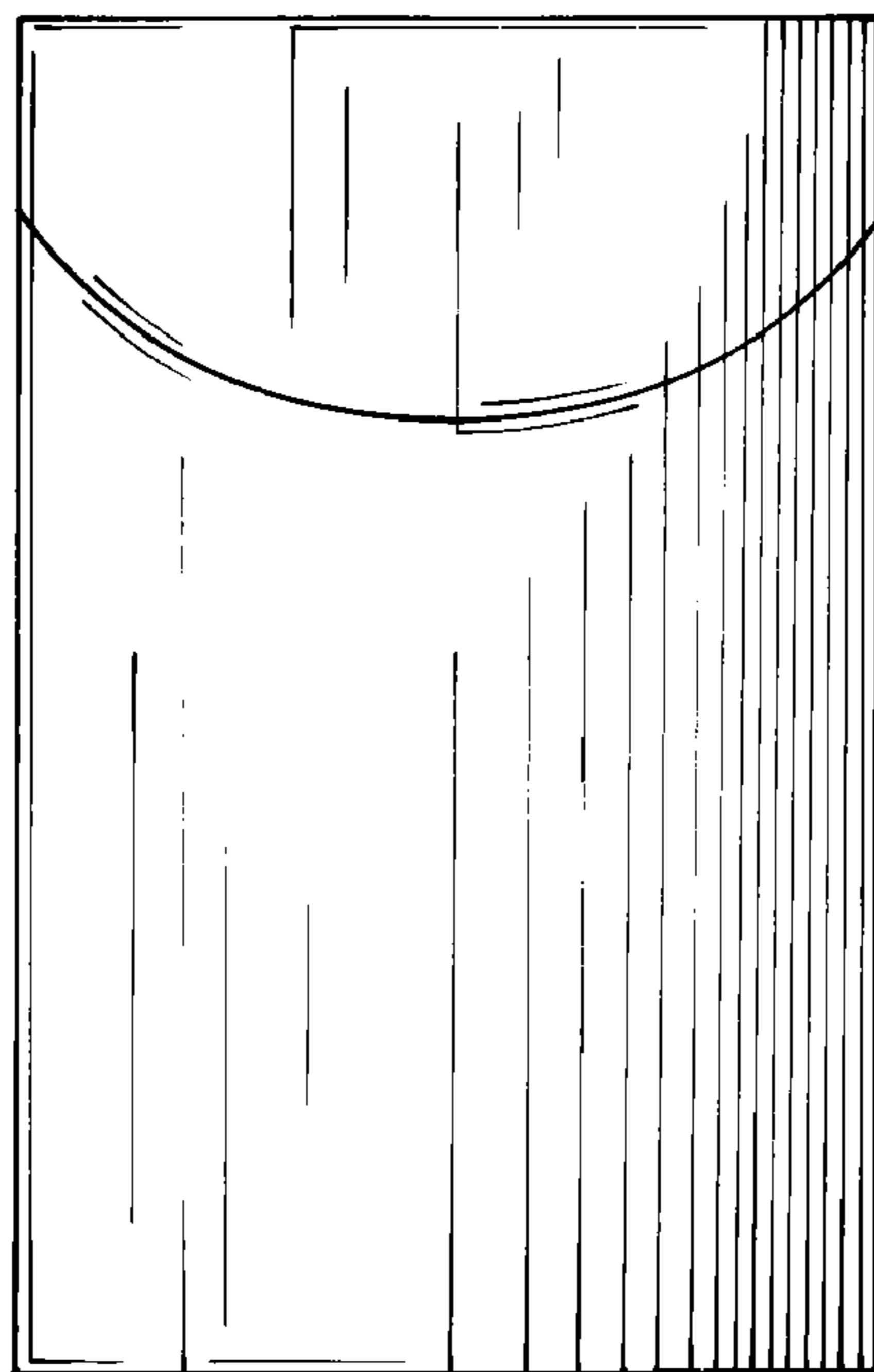

Fig. 12

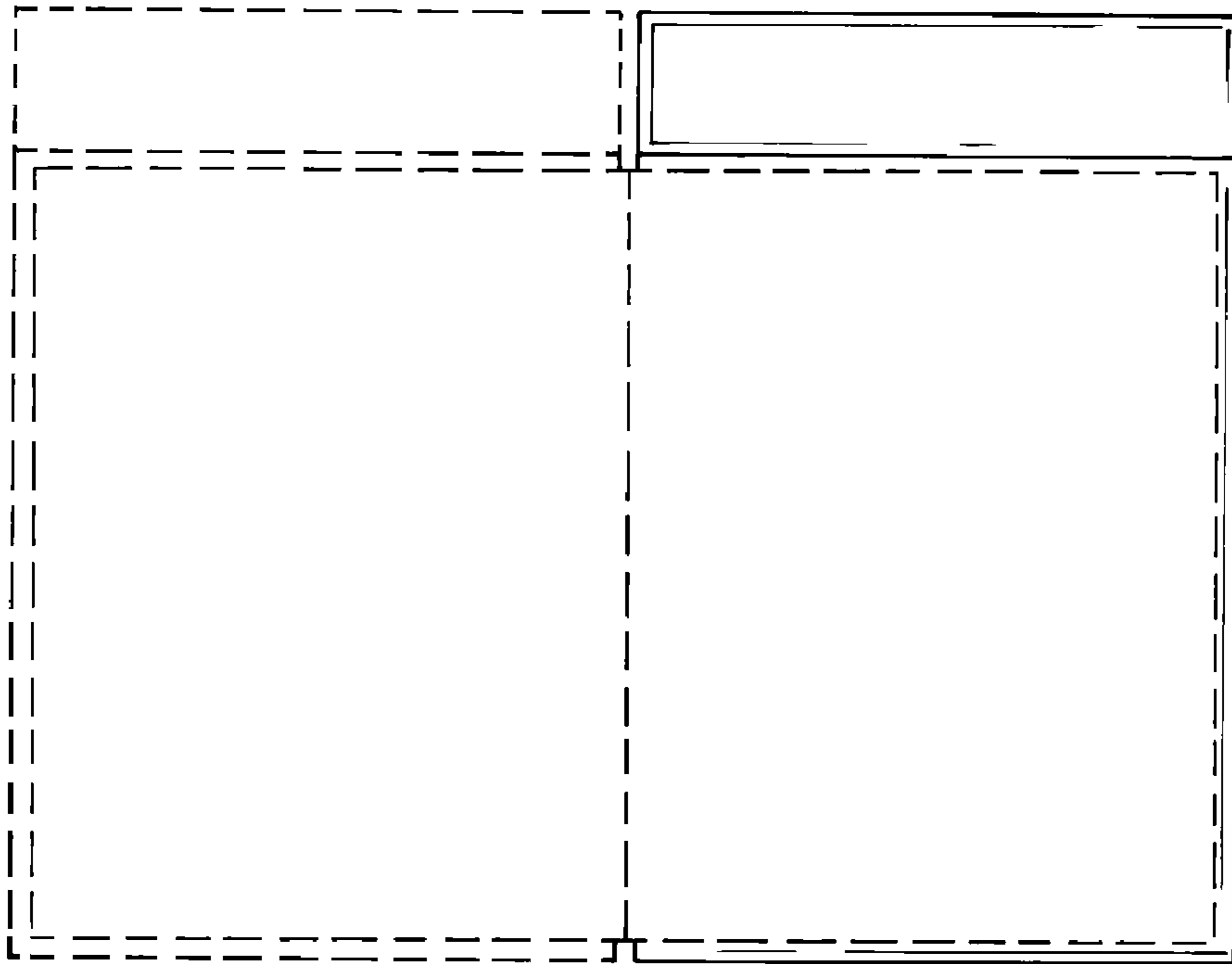

Fig. 13

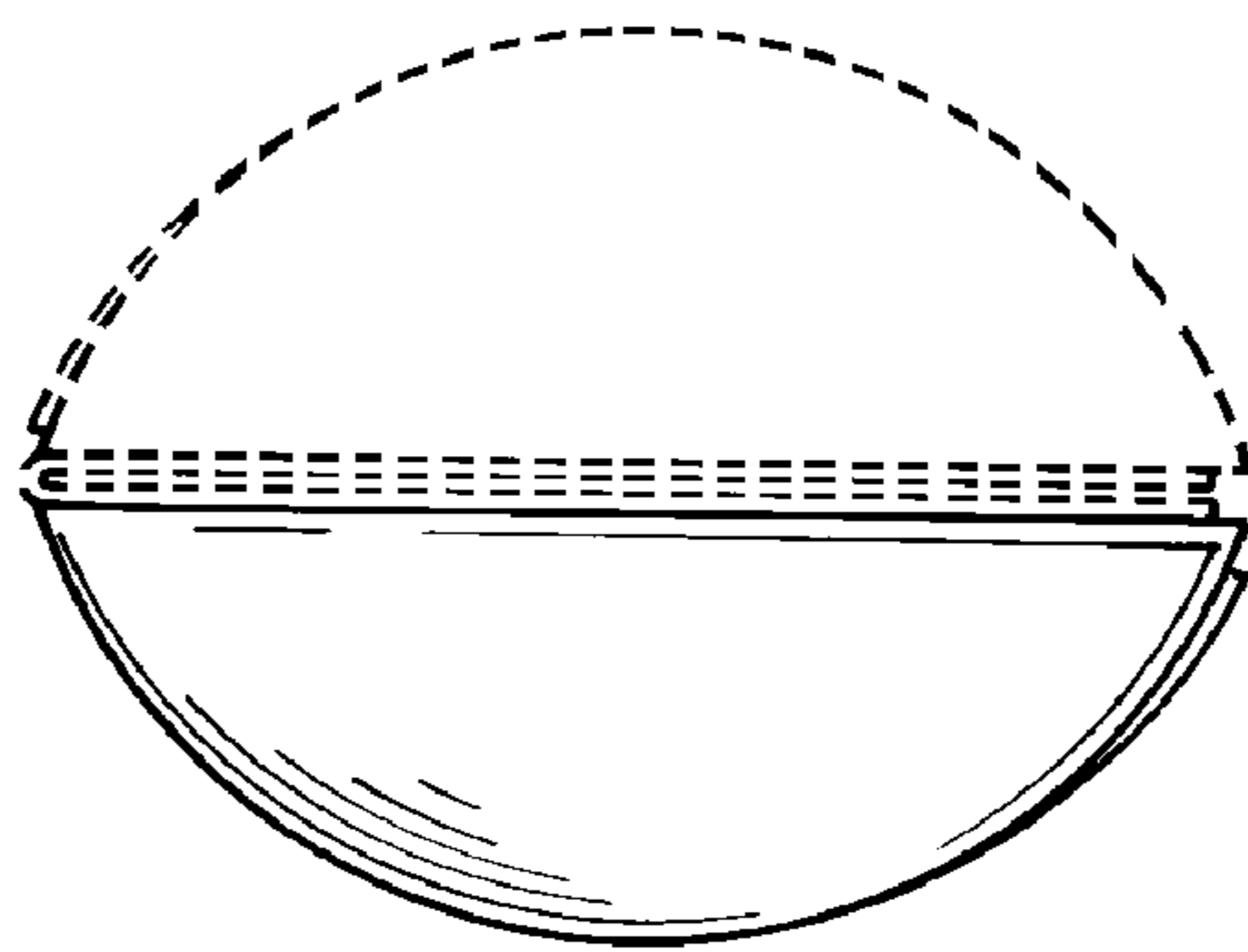

Fig. 14

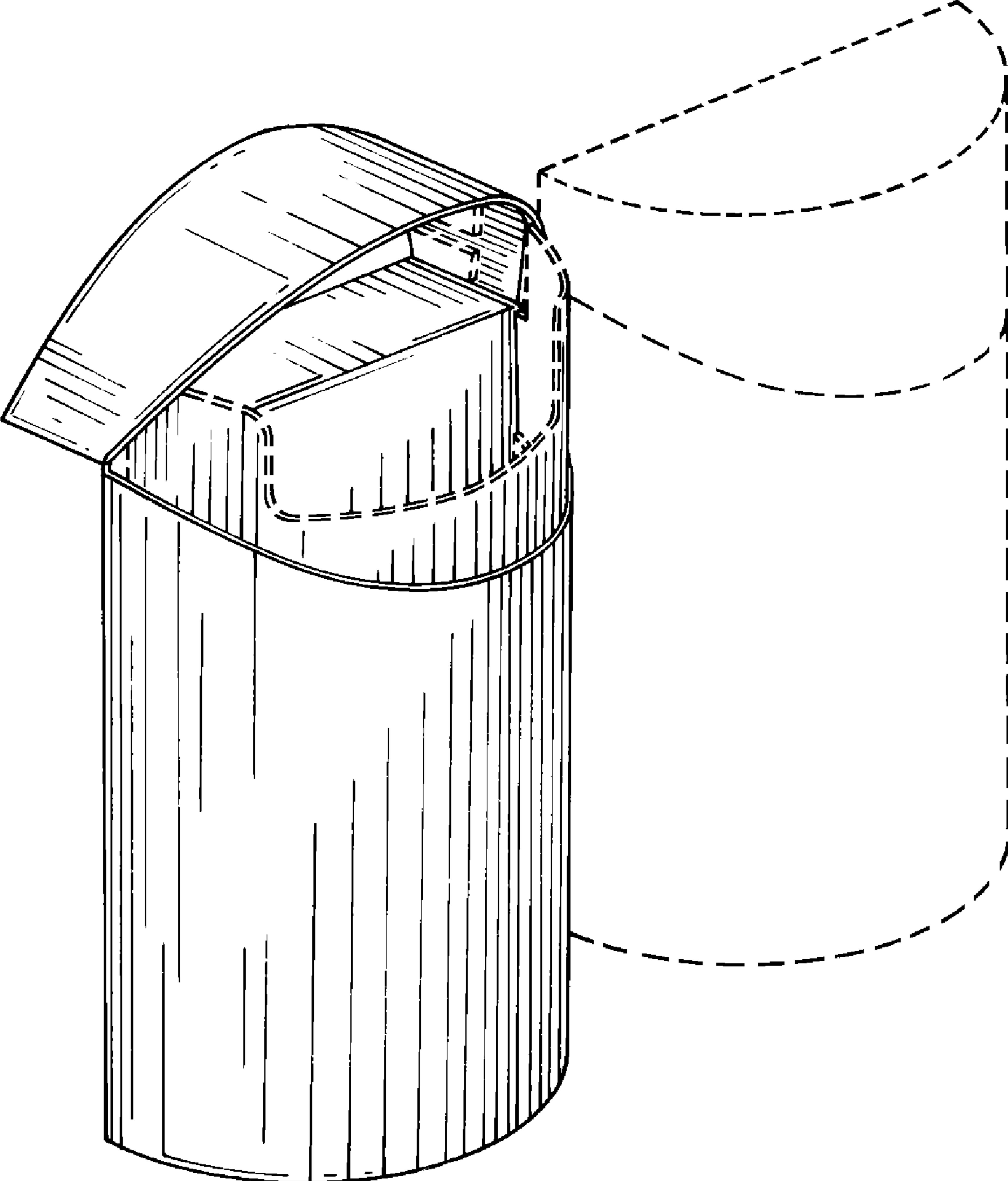

Fig. 15

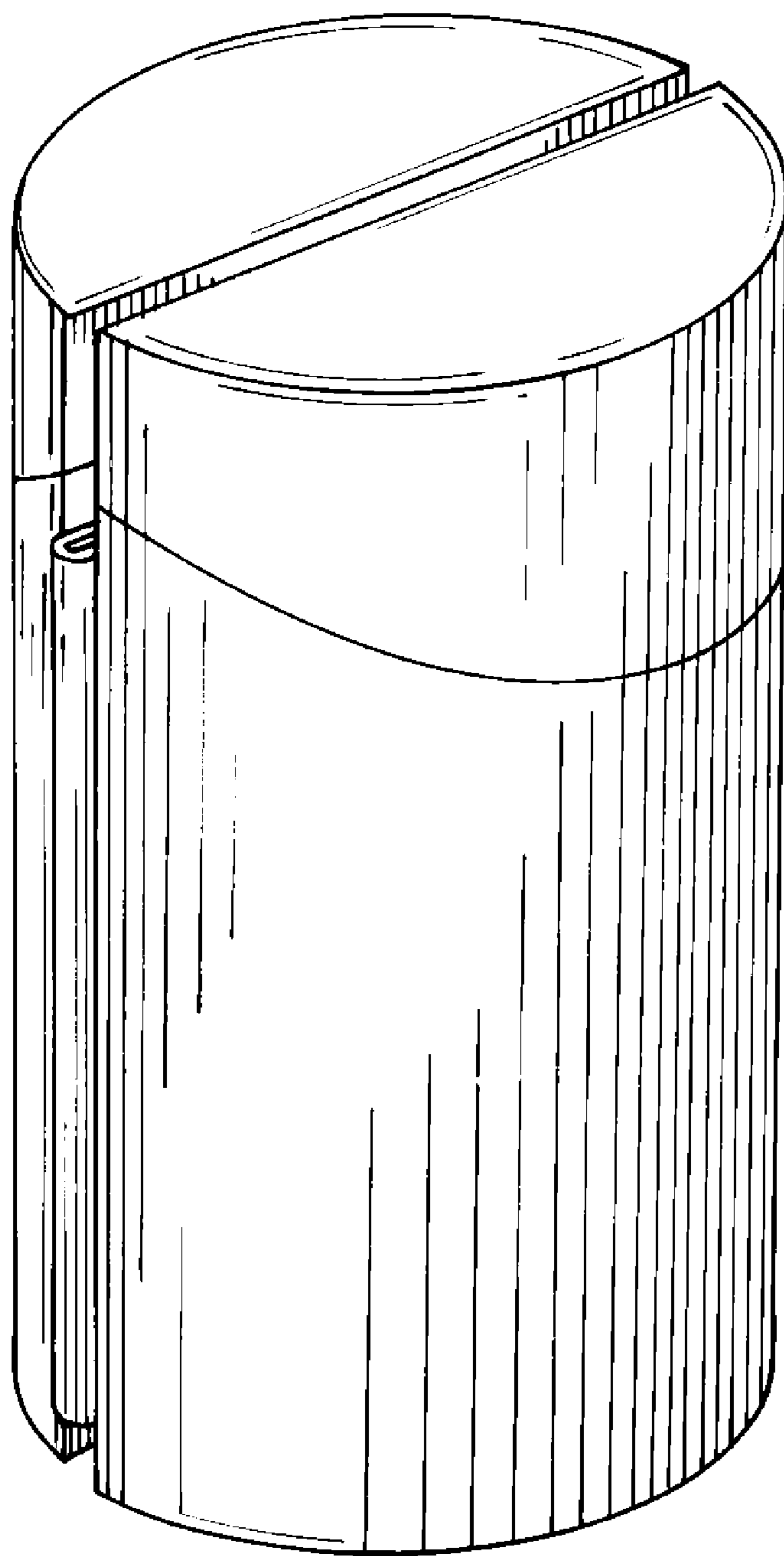

Fig. 16

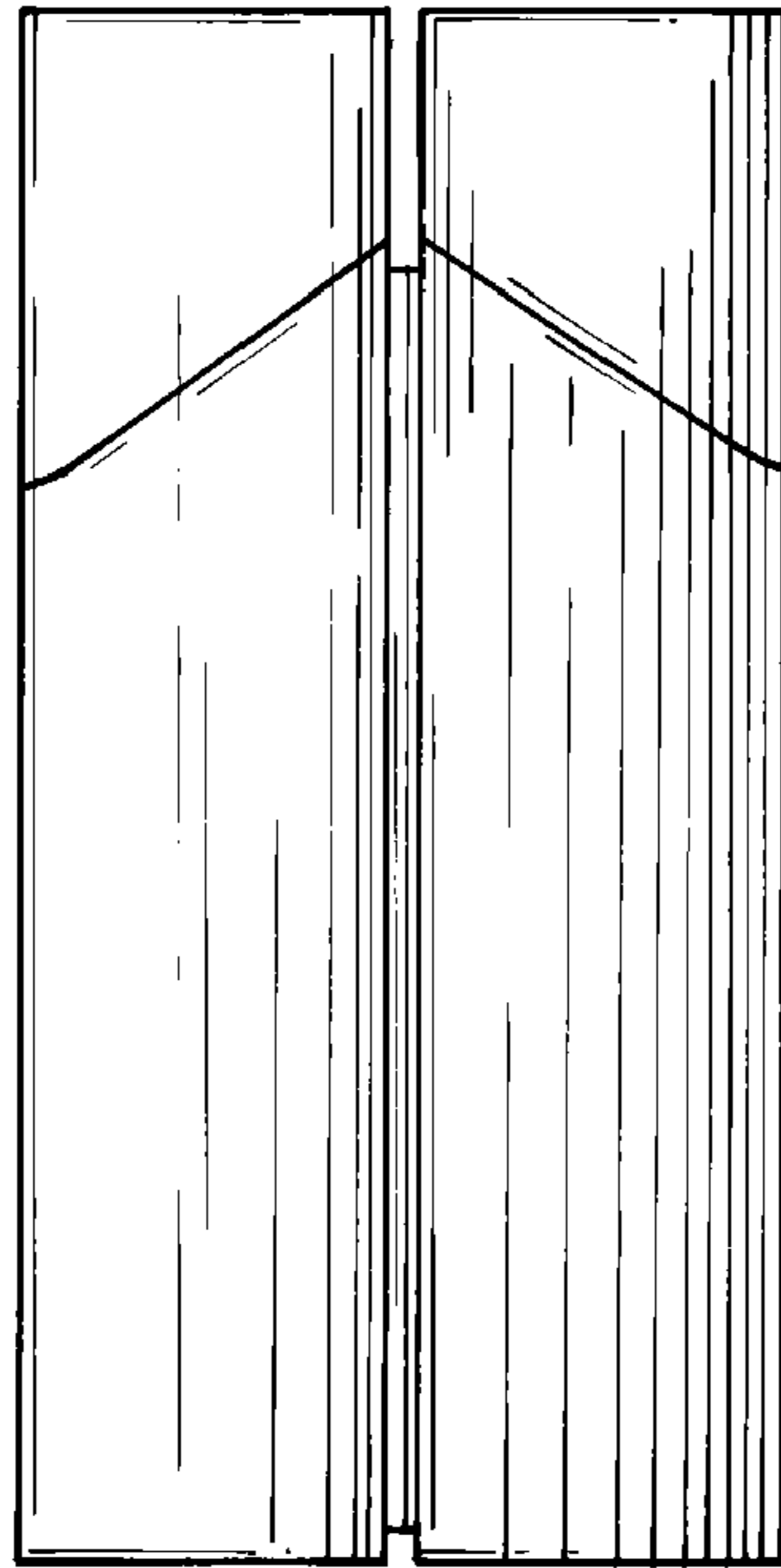

Fig. 17

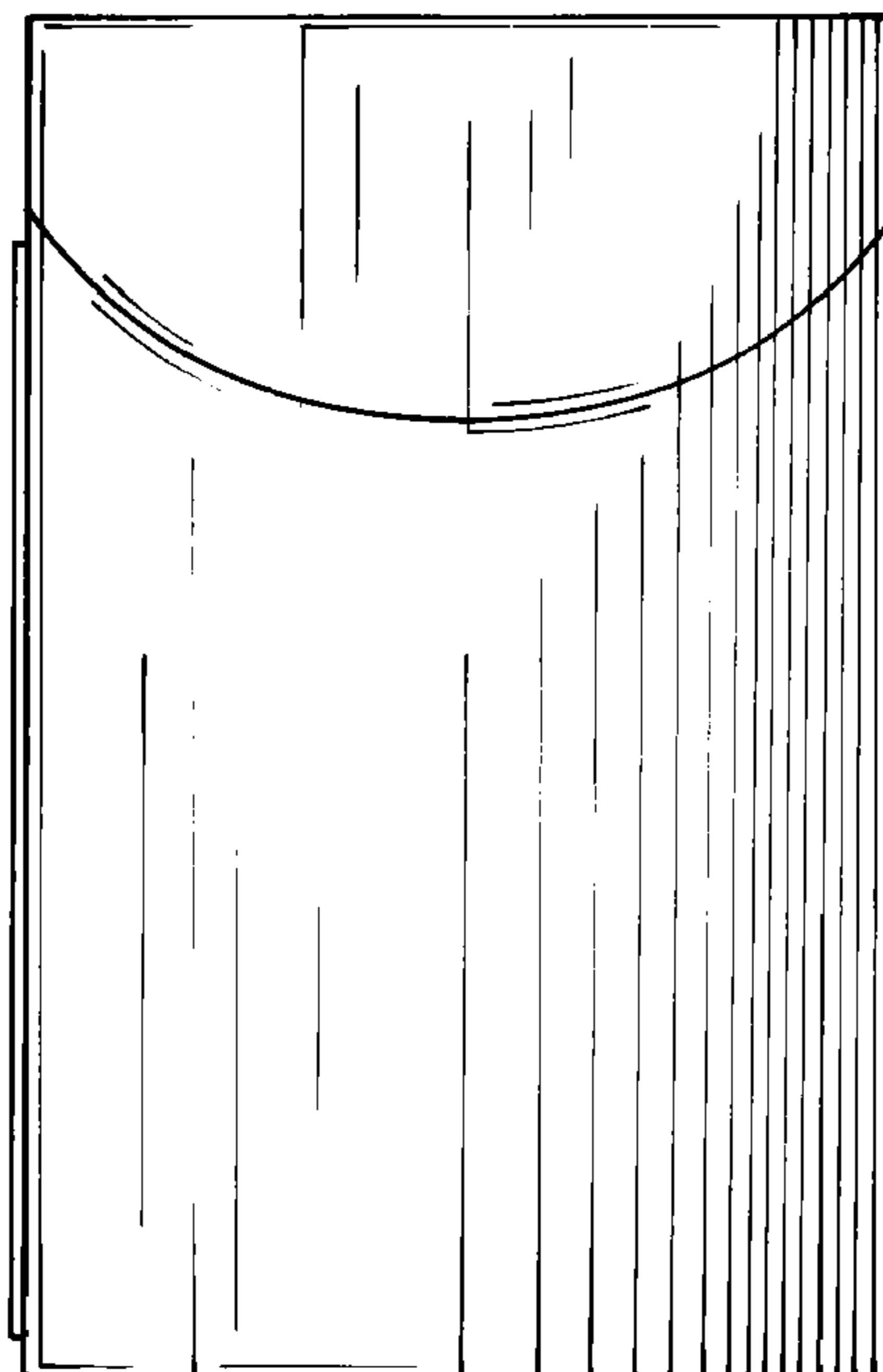

Fig. 18

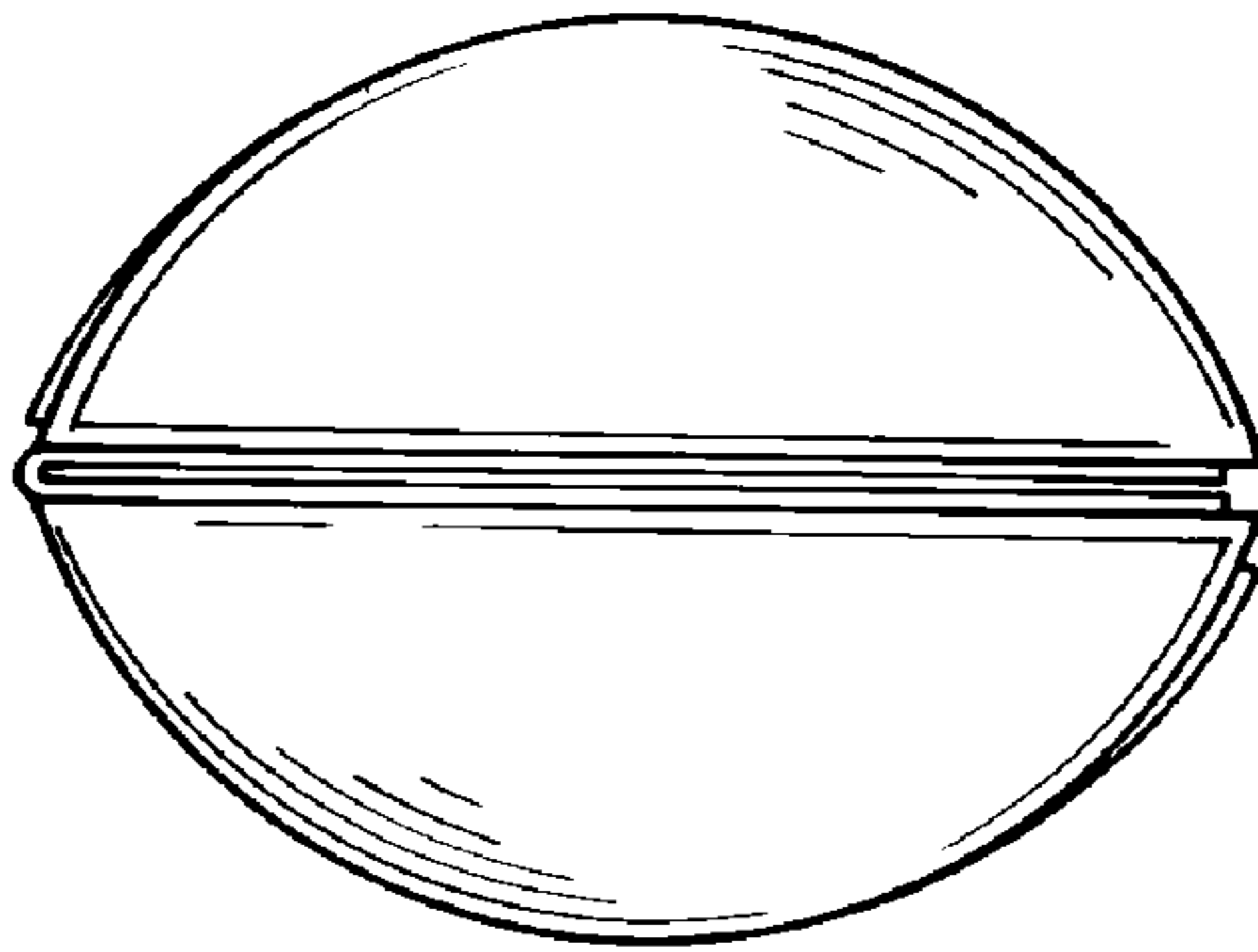

Fig. 19

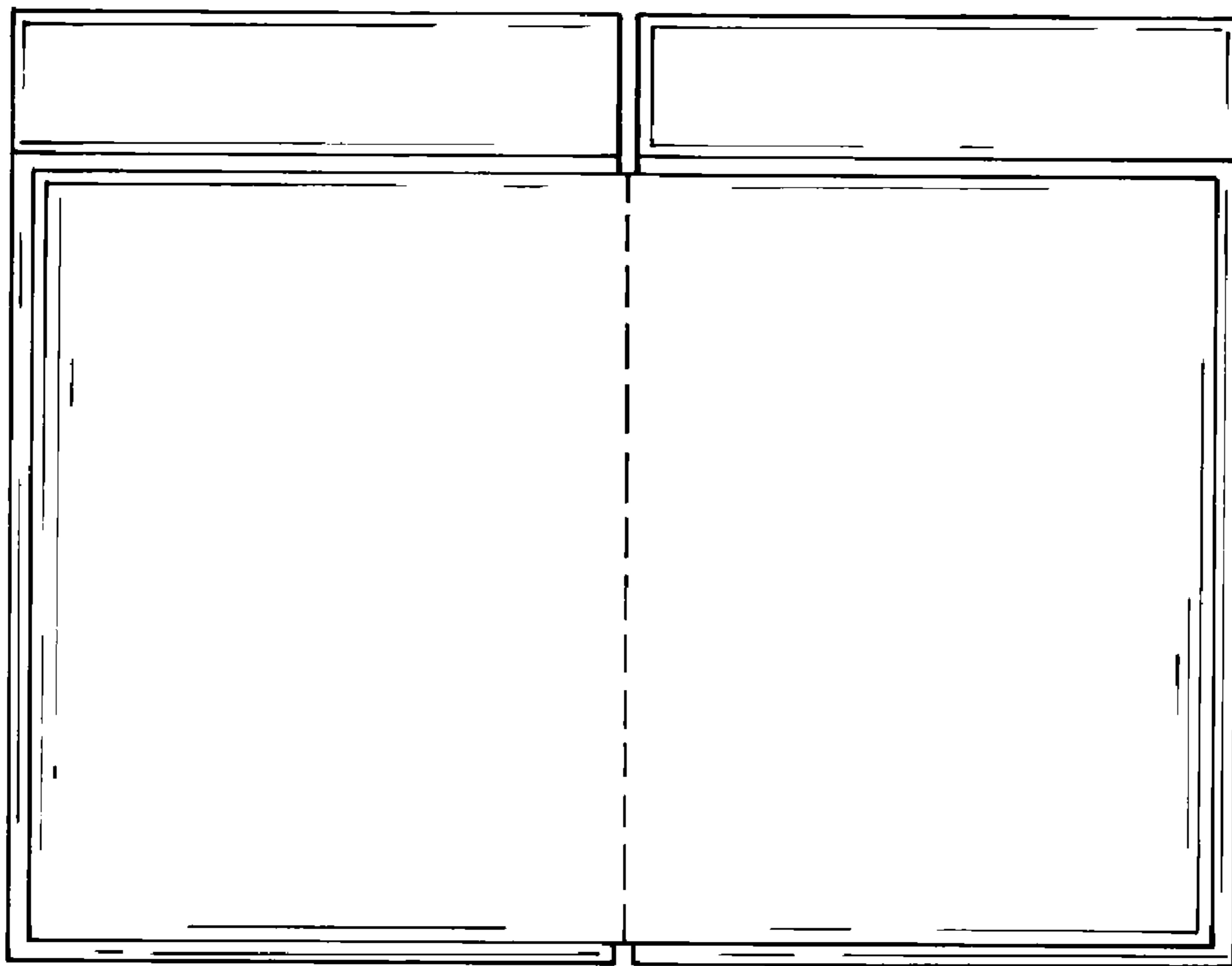

Fig. 20

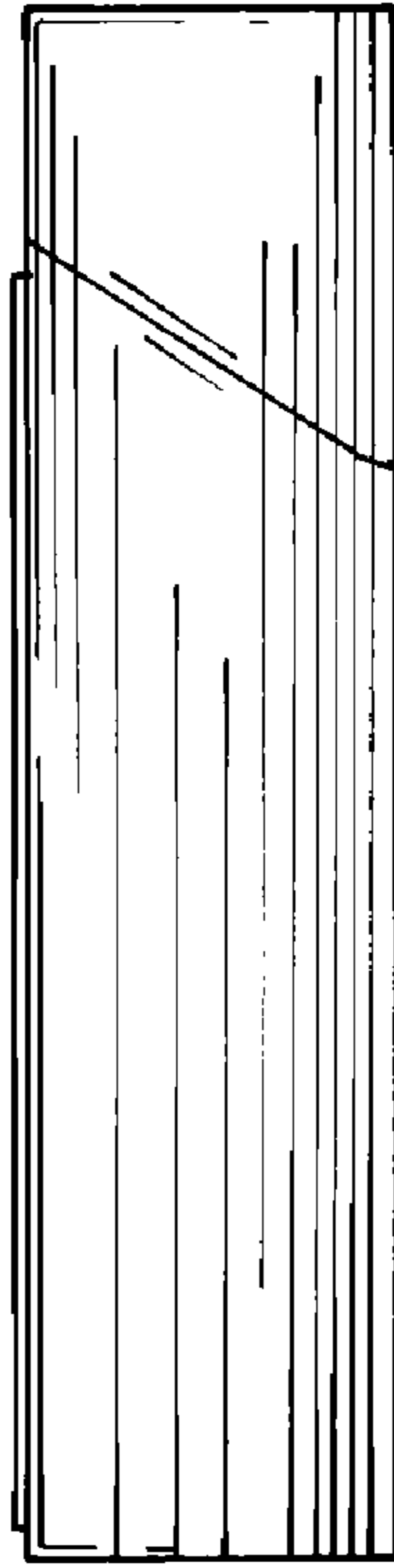

Fig. 21

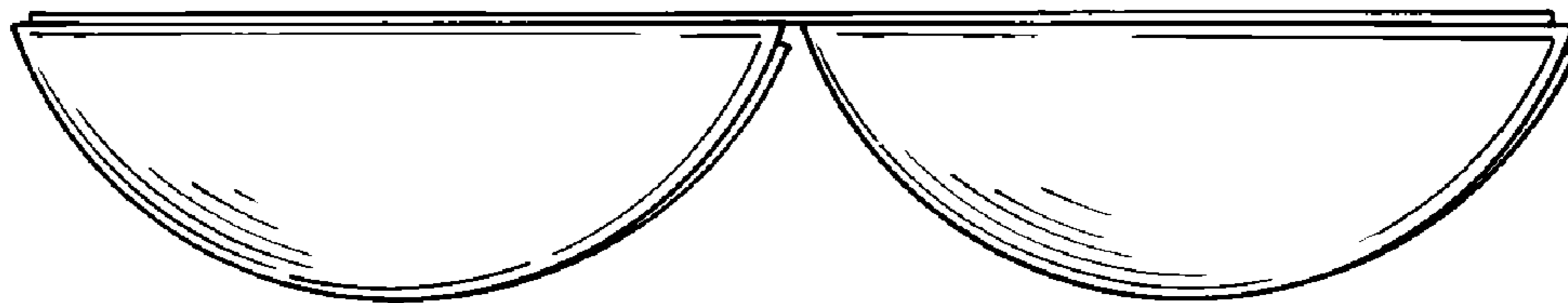

Fig. 22