



US00D575346S

(12) **United States Design Patent**
Yuen

(10) **Patent No.:** **US D575,346 S**

(45) **Date of Patent:** **** Aug. 19, 2008**

(54) **TAPE DISPENSER WITH USB HUB**

(75) Inventor: **Chun Fat Yuen**, Kowloon (HK)

(73) Assignee: **Earth Trek (Hong Kong) Ltd.**, Hong Kong (CN)

(**) Term: **14 Years**

(21) Appl. No.: **29/250,532**

(22) Filed: **Nov. 18, 2006**

(30) **Foreign Application Priority Data**

Sep. 21, 2006 (HK) 0602439

(51) **LOC (8) Cl.** **08-02**

(52) **U.S. Cl.** **D19/69**

(58) **Field of Classification Search** D19/36,
D19/70, 69, 68; D13/133, 146; 242/588.6,
242/588.3, 588.2; 225/77, 6, 56, 39, 26,
225/25, 19, 11; 206/411; 156/577, 527,
156/523

See application file for complete search history.

(56) **References Cited**

U.S. PATENT DOCUMENTS

D177,224 S * 3/1956 Gershen D19/69
3,846,248 A * 11/1974 Rose 435/309.1
D248,561 S * 7/1978 Deering, Jr. D19/69
4,527,722 A * 7/1985 Strachan 225/106
D289,180 S * 4/1987 Crawford et al. D19/69
D300,750 S * 4/1989 Mead D19/67

D305,249 S * 12/1989 Ukisu D21/532
D319,847 S * 9/1991 Evenson D19/69
D330,727 S * 11/1992 Wehrle D19/69
D331,072 S * 11/1992 Dotterman et al. D19/69
D407,750 S * 4/1999 Watters D19/69
D540,872 S * 4/2007 Goolrick D19/69

* cited by examiner

Primary Examiner—Cathron C. Brooks

Assistant Examiner—Austin Murphy

(74) *Attorney, Agent, or Firm*—McNeely Bodendorf LLP;
Kevin J. McNeely

(57) **CLAIM**

The ornamental design for a tape dispenser with USB ports,
as shown and described.

DESCRIPTION

FIG. 1 is a top view, showing the new design of the tape
dispenser with USB ports;

FIG. 2 is a bottom view;

FIG. 3 is a right side view;

FIG. 4 is a left side view;

FIG. 5 is a front view;

FIG. 6 is a back view;

FIG. 7 is a left-side perspective view with USB ports in an
extended position; and,

FIG. 8 is a right-side perspective view.

1 Claim, 2 Drawing Sheets

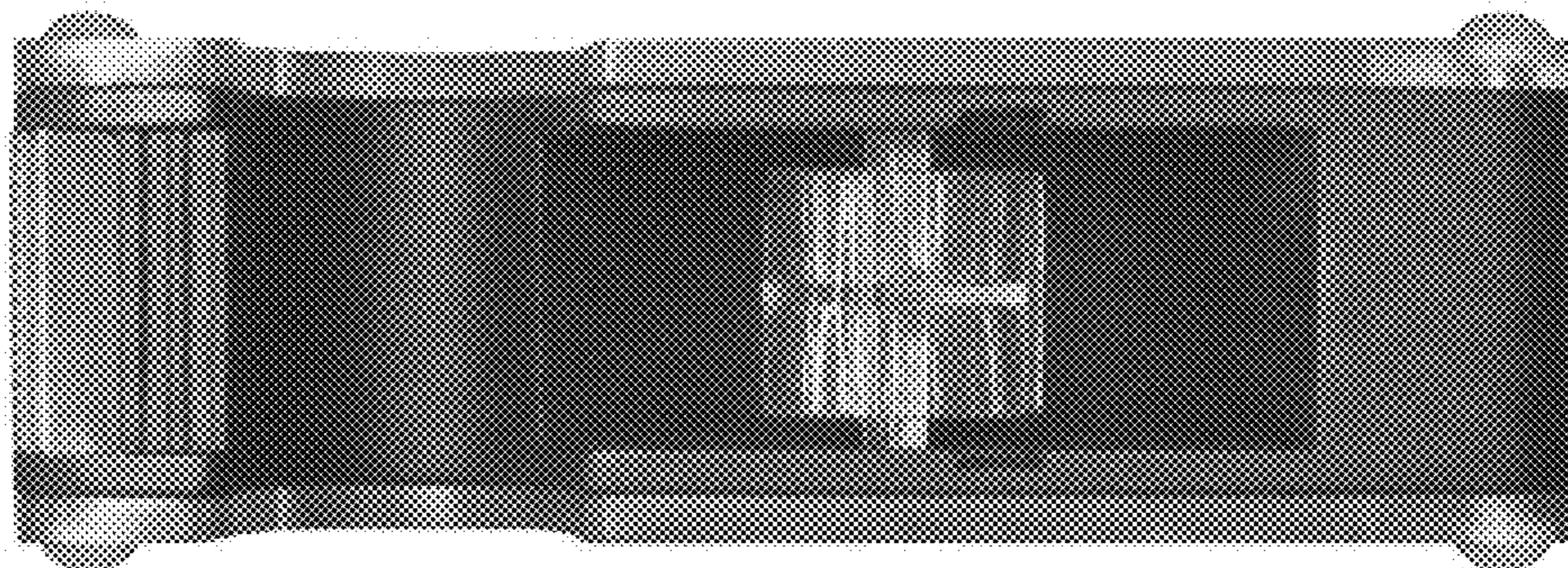

FIG. 1

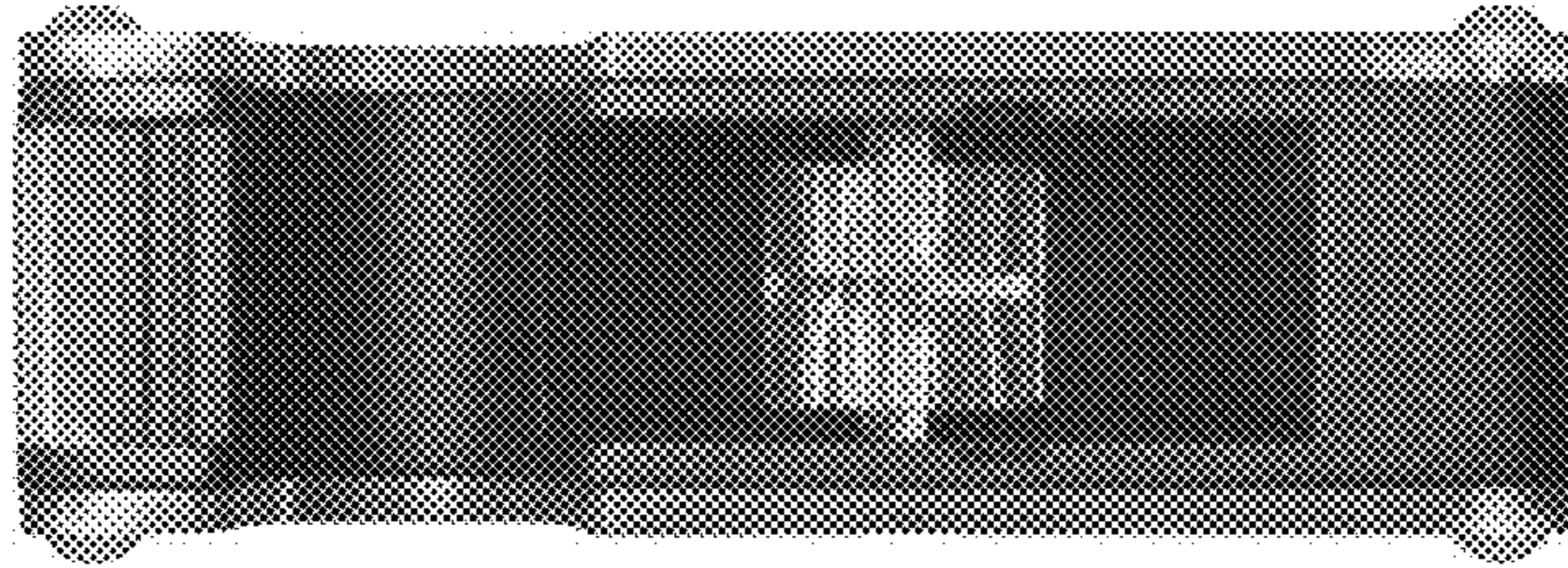

FIG. 2

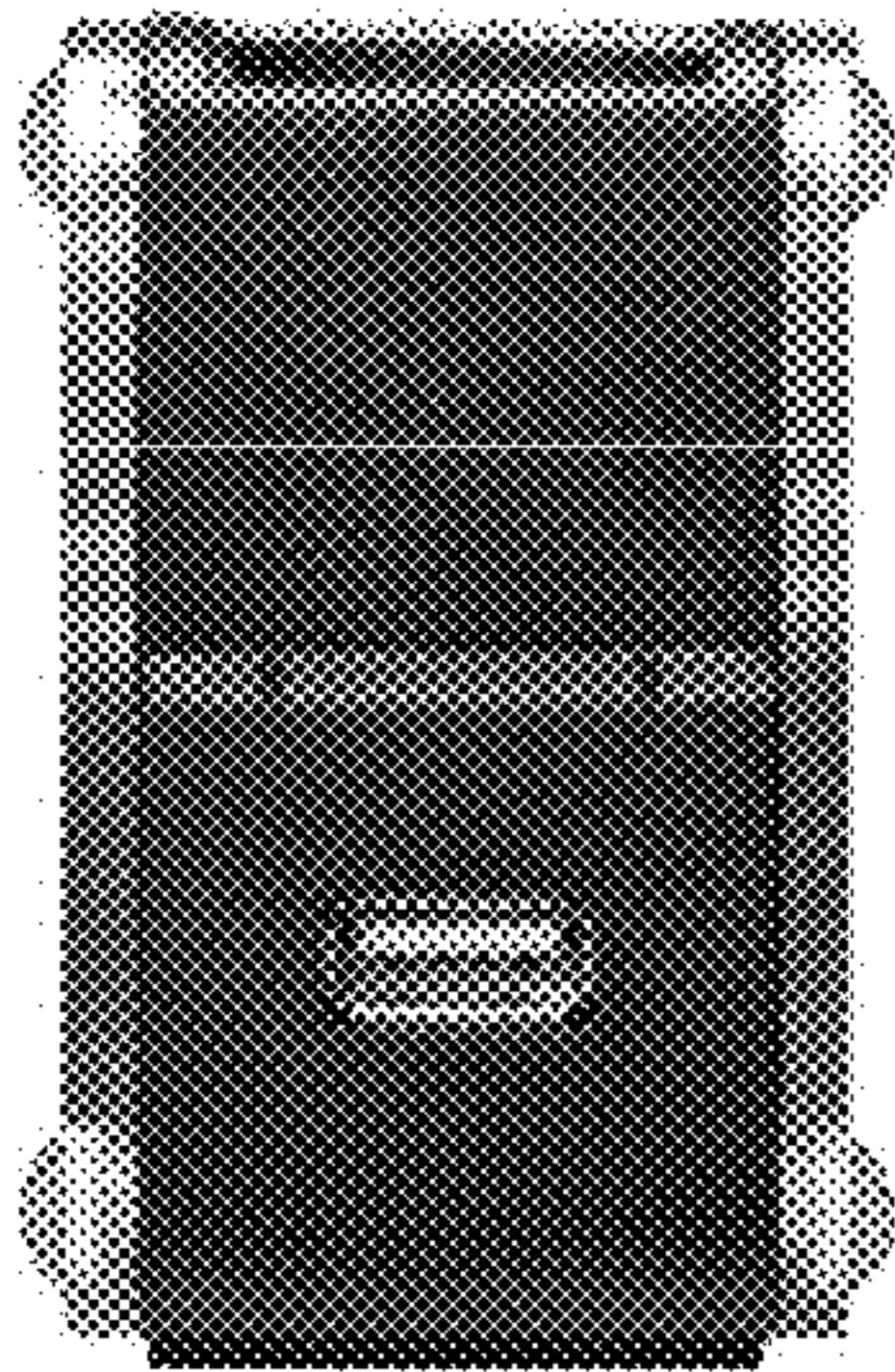
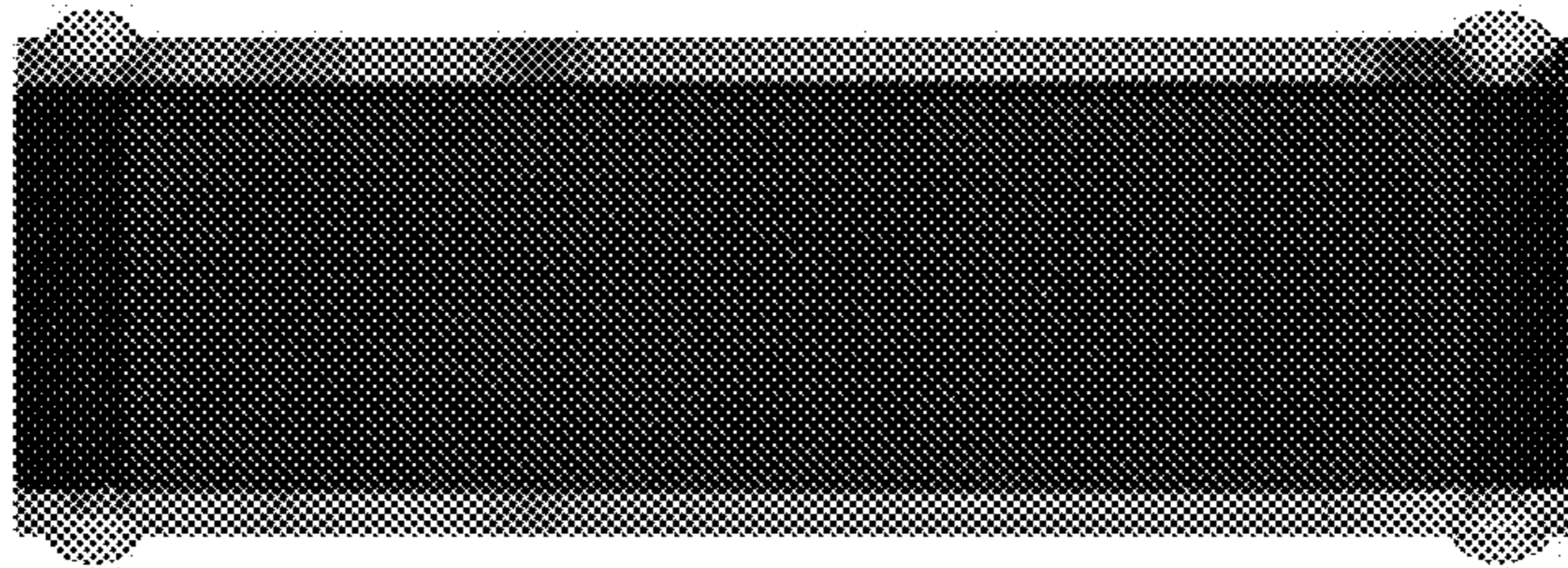

FIG. 5

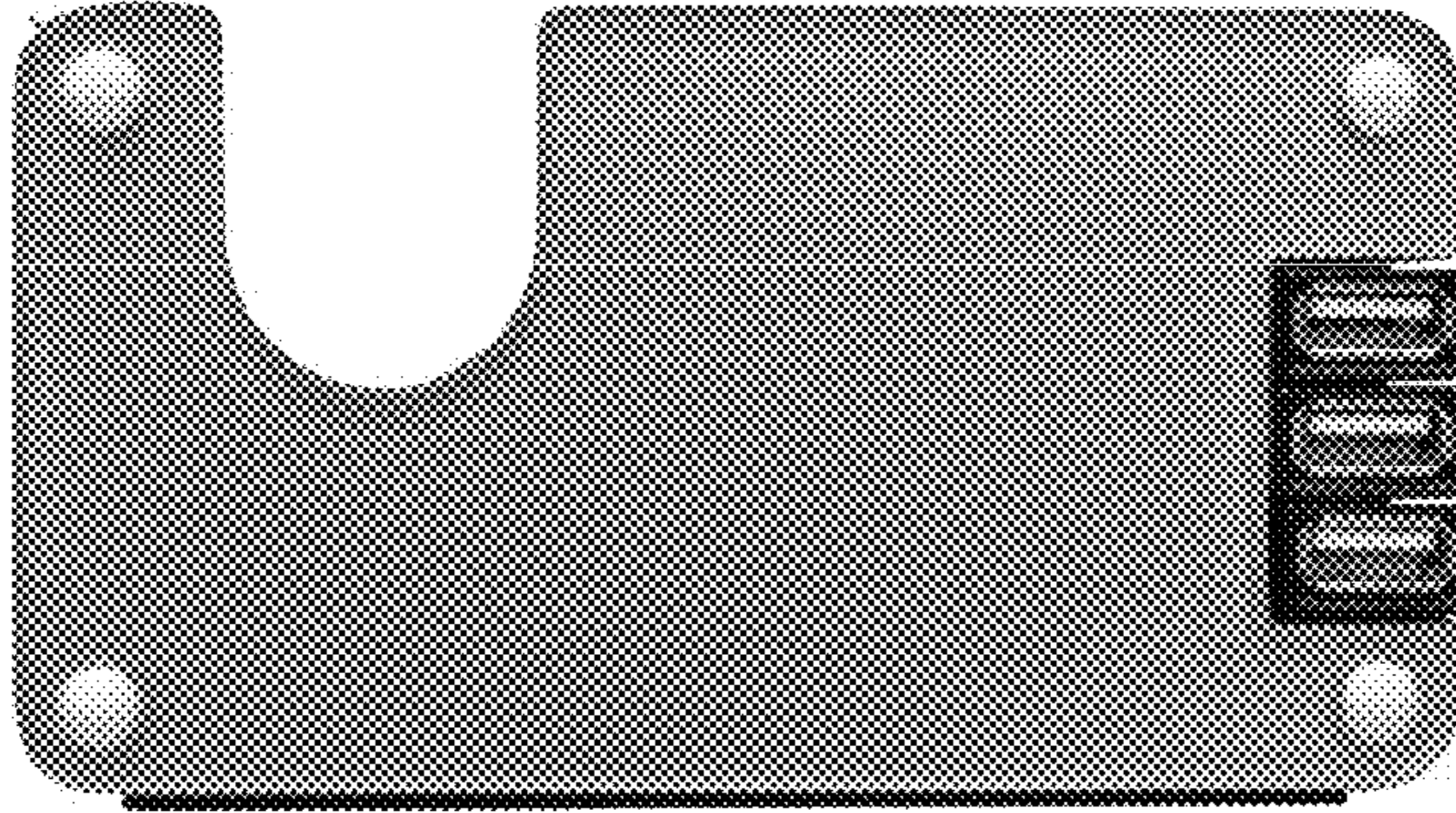

FIG. 3

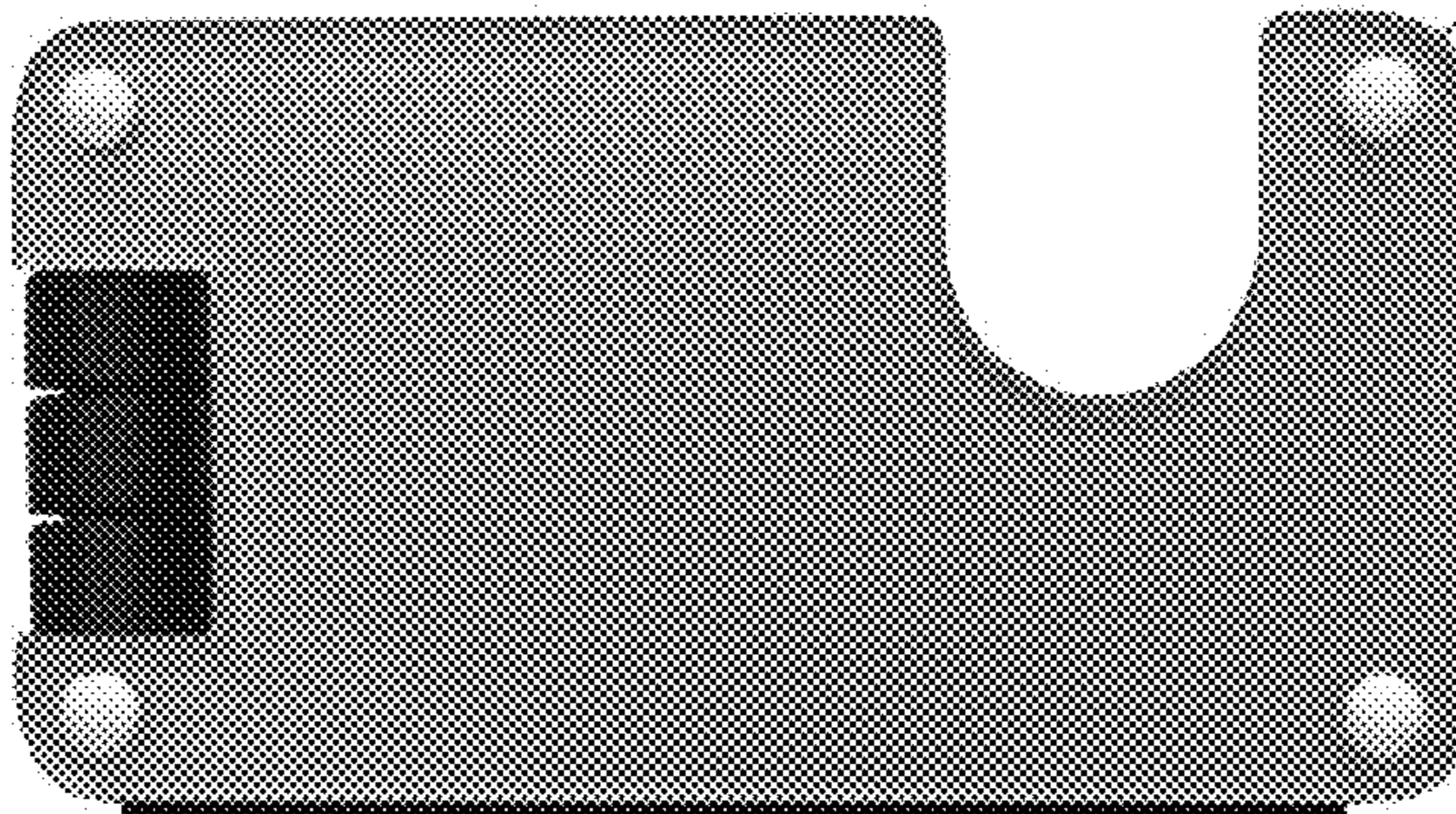

FIG. 4

FIG. 7

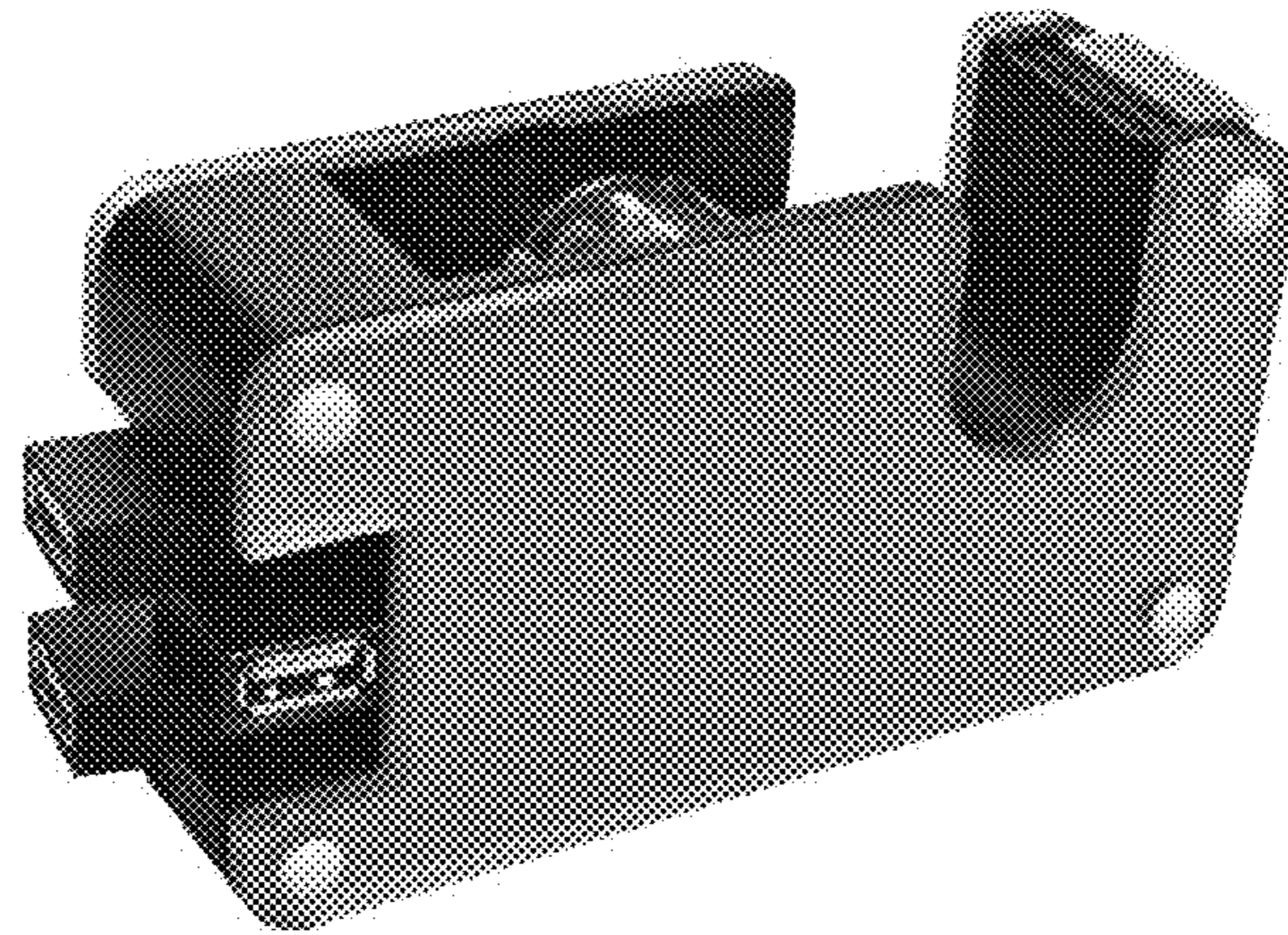

FIG. 6

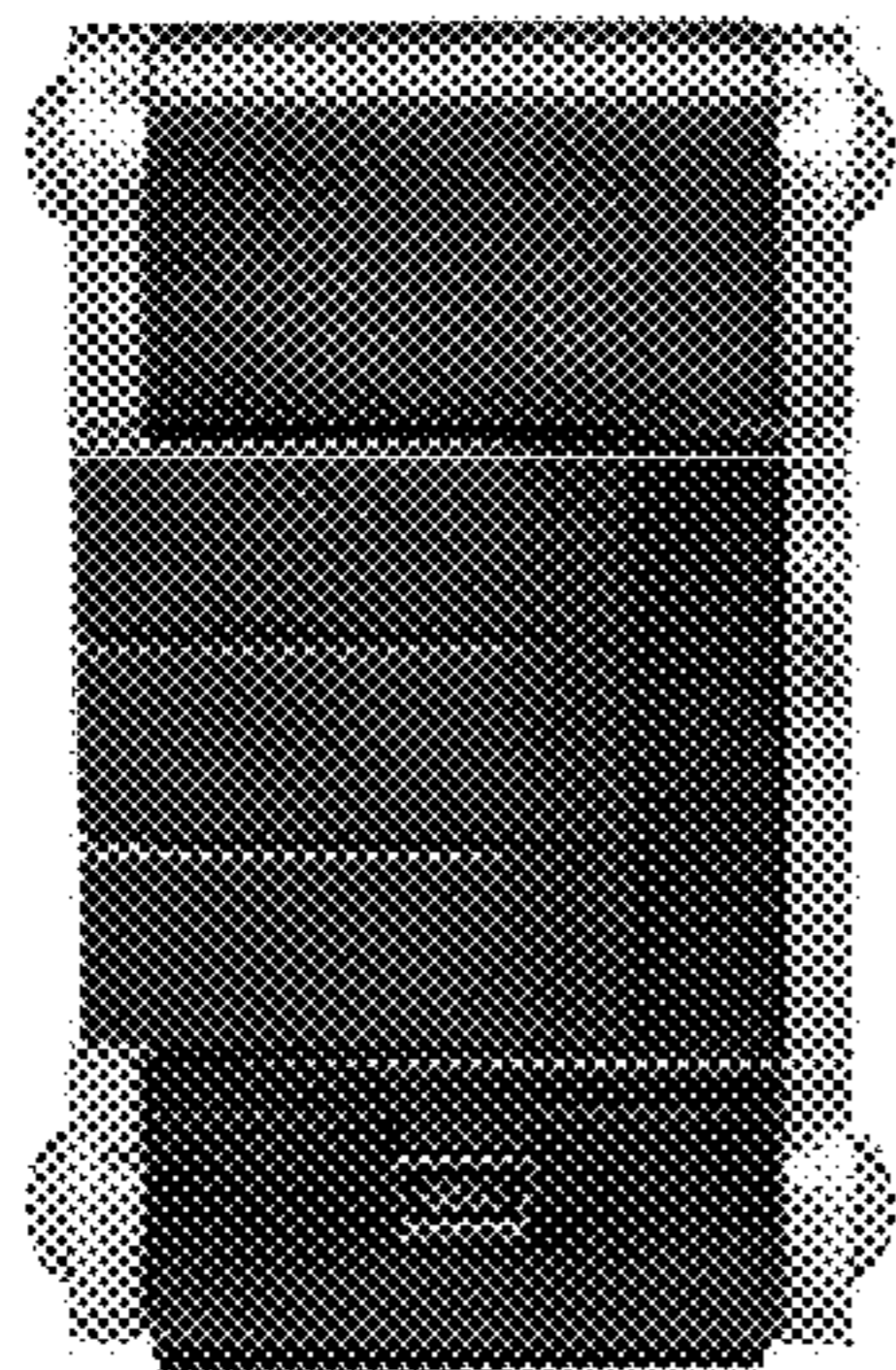

FIG. 8

