



US00D575256S

(12) **United States Design Patent**
Kim et al.

(10) **Patent No.:** **US D575,256 S**
(45) **Date of Patent:** **** Aug. 19, 2008**

(54) **PORTABLE PHONE**

(75) Inventors: **Hyun-Sook Kim**, Yeongin-si (KR);
Yoon-Young Cho, Seoul (KR);
Chang-Hwan Hwang, Goyang-Si (KR)

(73) Assignee: **Samsung Electronics Co., Ltd.**,
Suwon-Si (KR)

(**) Term: **14 Years**

(21) Appl. No.: **29/262,104**

(22) Filed: **Jun. 27, 2006**

(30) **Foreign Application Priority Data**

Dec. 28, 2005 (KR) 30-2005-0044431

(51) **LOC (8) Cl.** **14-03**

(52) **U.S. Cl.** **D14/138**

(58) **Field of Classification Search** D14/138,
D14/496, 341-347; 455/575.3, 575.1; D21/517
See application file for complete search history.

(56) **References Cited**

U.S. PATENT DOCUMENTS

D501,839 S *	2/2005	Lee et al.	D14/138
D508,475 S *	8/2005	Wu et al.	D14/138
D519,972 S *	5/2006	Chung et al.	D14/138
D521,970 S *	5/2006	Han et al.	D14/138
D540,767 S *	4/2007	Kim et al.	D14/138
D541,248 S *	4/2007	Lee et al.	D14/138
D545,796 S *	7/2007	Kim et al.	D14/138
D546,312 S *	7/2007	Han et al.	D14/138
D546,794 S *	7/2007	Kim et al.	D14/138
D546,796 S *	7/2007	Ahn et al.	D14/138
7,286,861 B2 *	10/2007	Woo	455/575.3
D558,167 S *	12/2007	Jung et al.	D14/138
D558,170 S *	12/2007	Wang et al.	D14/138
D558,712 S *	1/2008	Kim et al.	D14/138
D560,183 S *	1/2008	Kim et al.	D14/138

(Continued)

OTHER PUBLICATIONS

Samsung Z710 telephone, announced Feb. 2006, [online], [site visited Apr. 12, 2008]. Available from Internet ,<URL: <http://www.gsmarena.com>>.*

Samsung P850 telephone, 1st quarter 2005, [online], [site visited Apr. 12, 2008]. Available from Internet ,<URL: <http://www.gsmarena.com>>.*

Samsung P730 telephone, announced Mar. 2004, [online], [site visited Apr. 12, 2008]. Available from Internet ,<URL: <http://www.gsmarena.com>>.*

Sagem myMobileTV 2 telephone, announced Feb. 2008, [online], [site visited Apr. 12, 2008]. Available from Internet ,<URL: <http://www.gsmarena.com>>.*

Samsung P940 telephone, announced Dec. 2006, [online], [site visited Apr. 12, 2008]. Available from Internet ,<URL: <http://www.gsmarena.com>>.*

Siemens SF65 telephone, 3rd quarter 2004, [online], [site visited Apr. 12, 2008]. Available from Internet ,<URL: <http://www.gsmarena.com>>.*

Primary Examiner—Jeffrey D Asch

(74) *Attorney, Agent, or Firm*—Staas & Halsey LLP

(57) **CLAIM**

The ornamental design for the portable phone, as shown and described.

DESCRIPTION

FIG. 1 is a perspective view of the portable phone showing our design;

FIG. 2 is a front view thereof;

FIG. 3 is a rear view thereof;

FIG. 4 is a left side view thereof;

FIG. 5 is a right side view thereof;

FIG. 6 is a top plan view thereof;

FIG. 7 is a bottom plan view thereof;

FIG. 8 is a front open view thereof; and,

FIG. 9 is a side, open view thereof with the display rotated to the right.

1 Claim, 6 Drawing Sheets

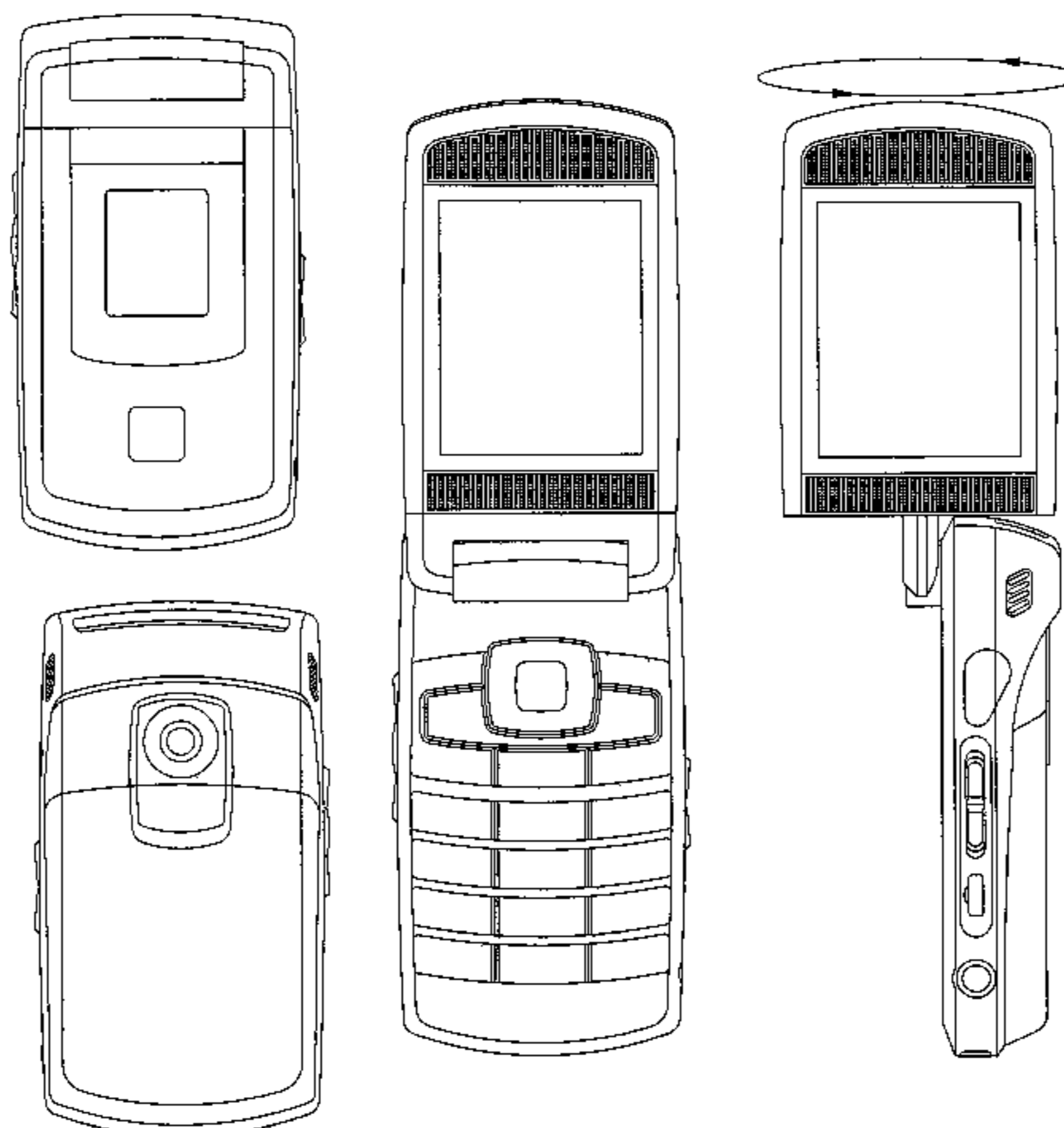

US D575,256 S

Page 2

U.S. PATENT DOCUMENTS

D560,189 S *	1/2008	Kim et al.	D14/138	D563,932 S *	3/2008	Song et al.	D14/138
D563,344 S *	3/2008	Kim et al.	D14/138	D566,092 S *	4/2008	Nishikawa	D14/138
D563,351 S *	3/2008	Baik et al.	D14/138	2006/0019728 A1 *	1/2006	Sakamoto et al.	455/575.3
D563,930 S *	3/2008	Kim et al.	D14/138	2006/0058079 A1 *	3/2006	Goto	455/575.3
				2007/0167197 A1 *	7/2007	Fuke et al.	455/575.1

* cited by examiner

FIG. 1

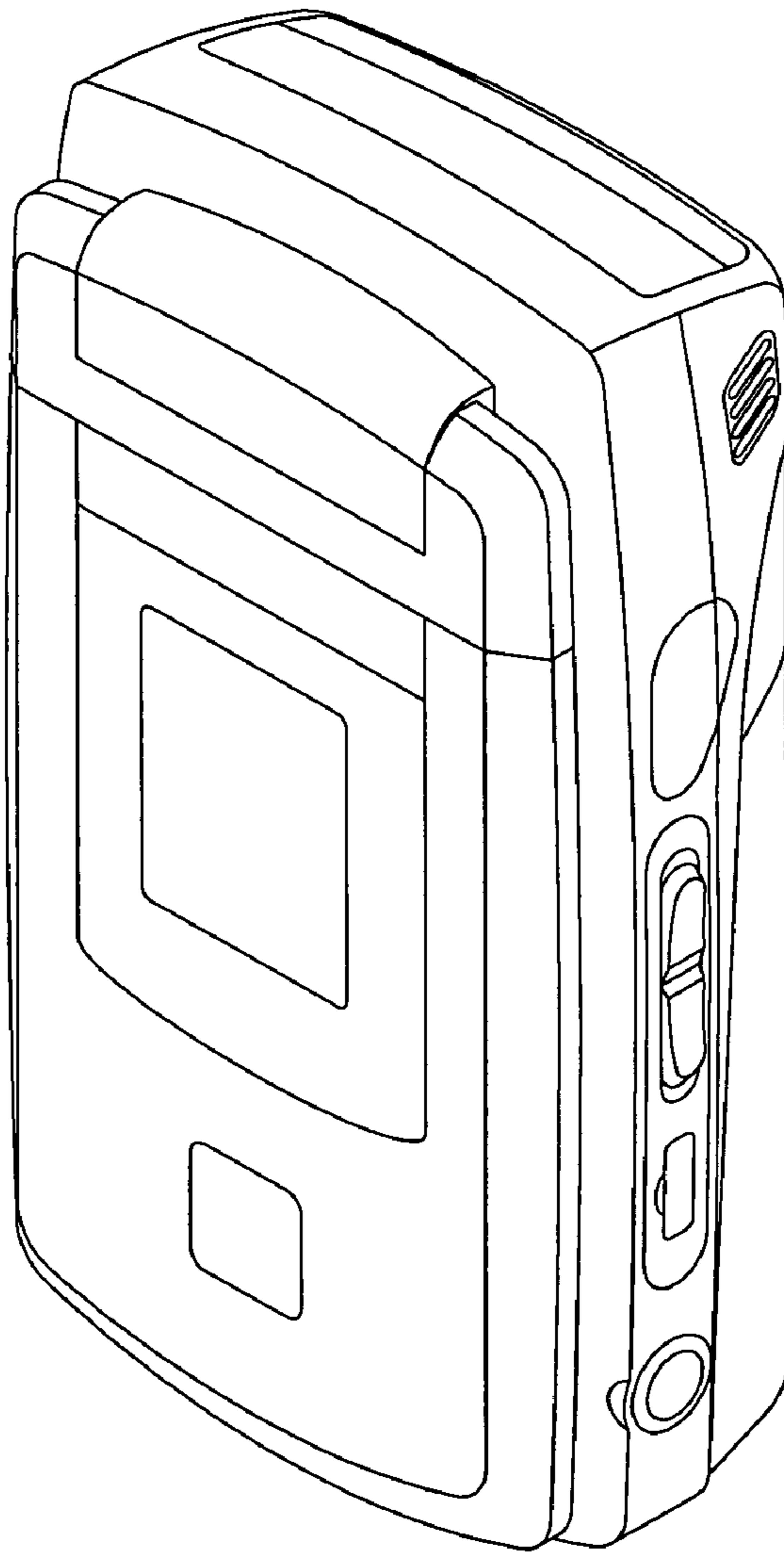

FIG. 2

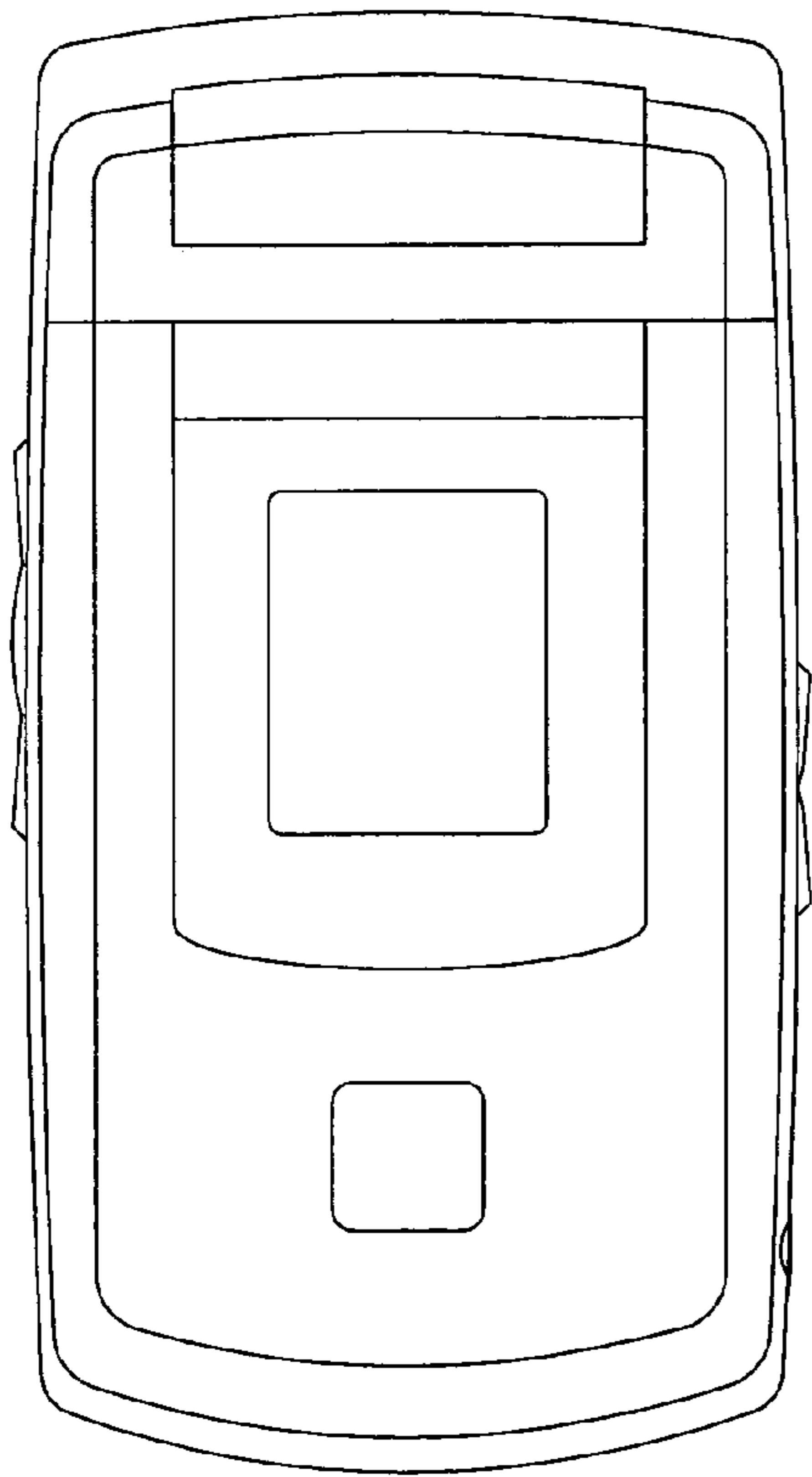

FIG. 3

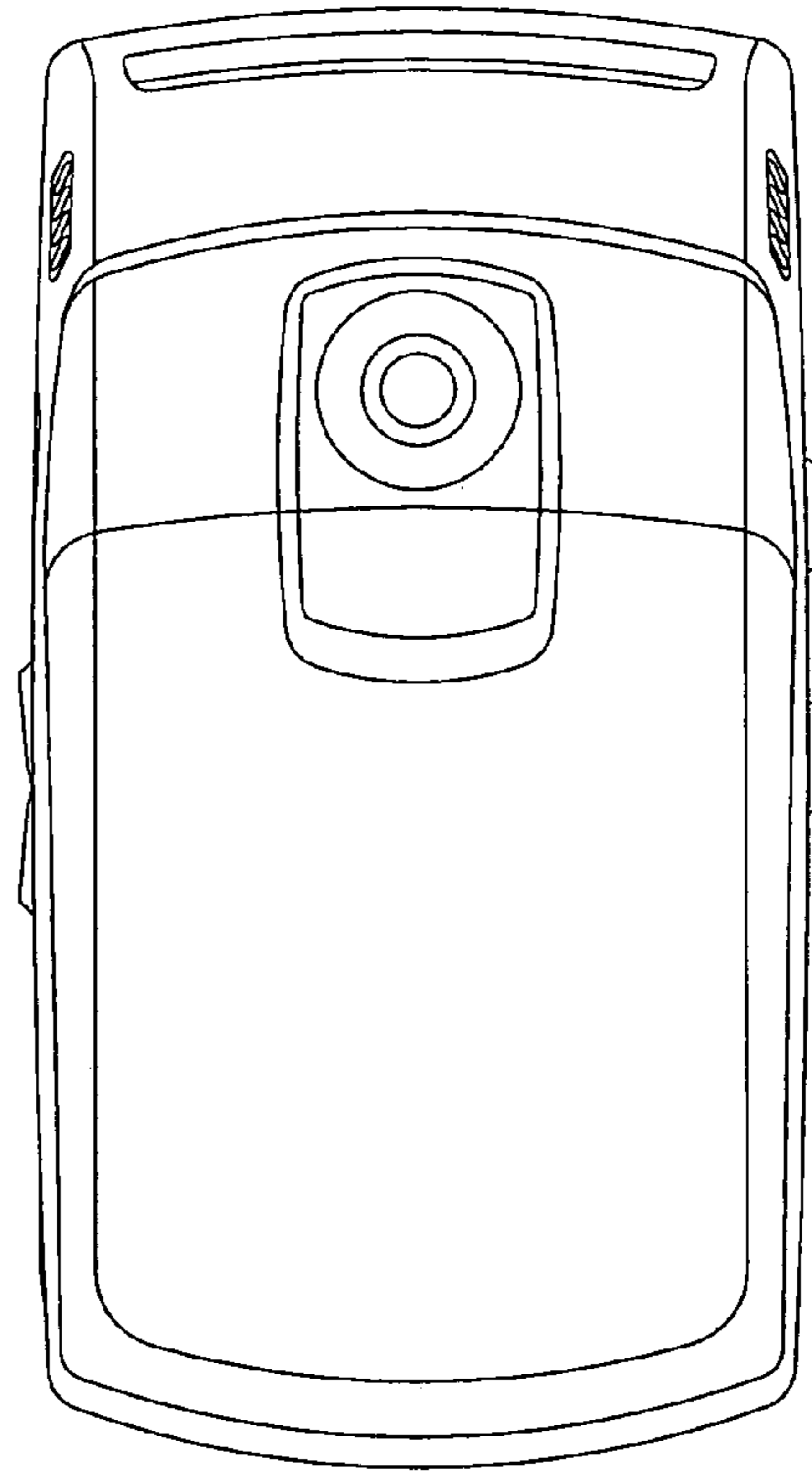

FIG. 4

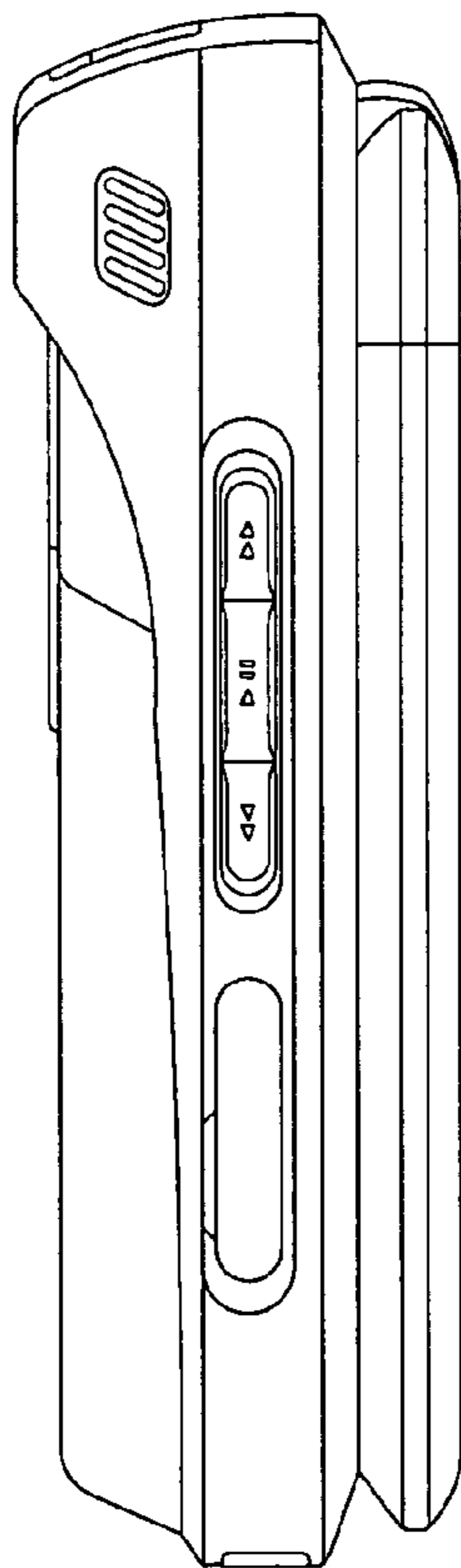

FIG. 5

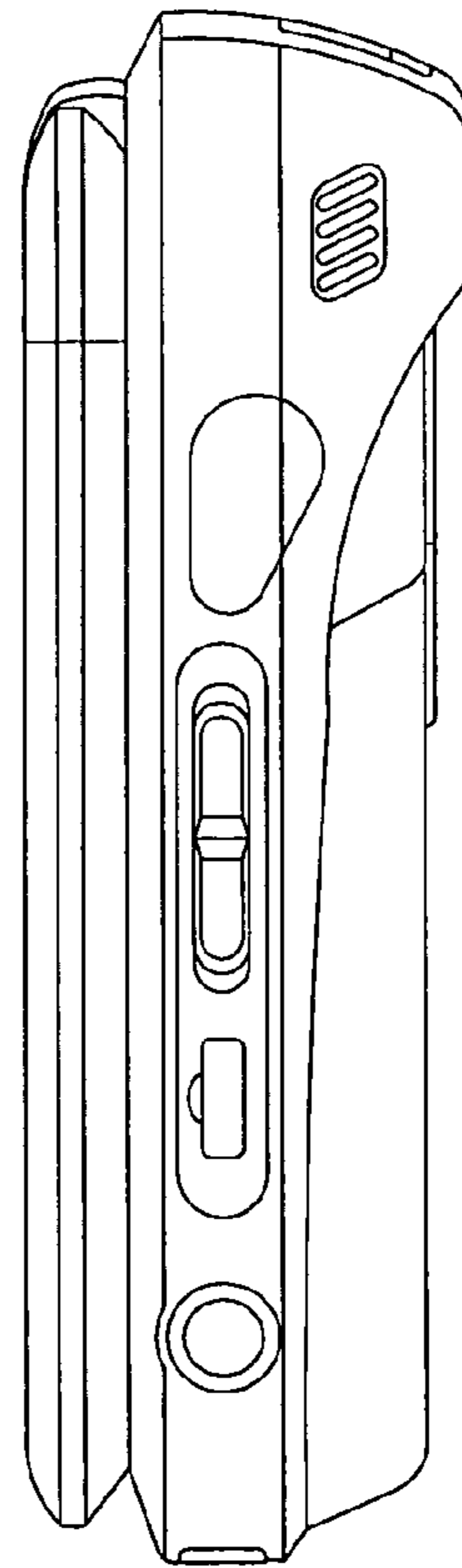

FIG. 6

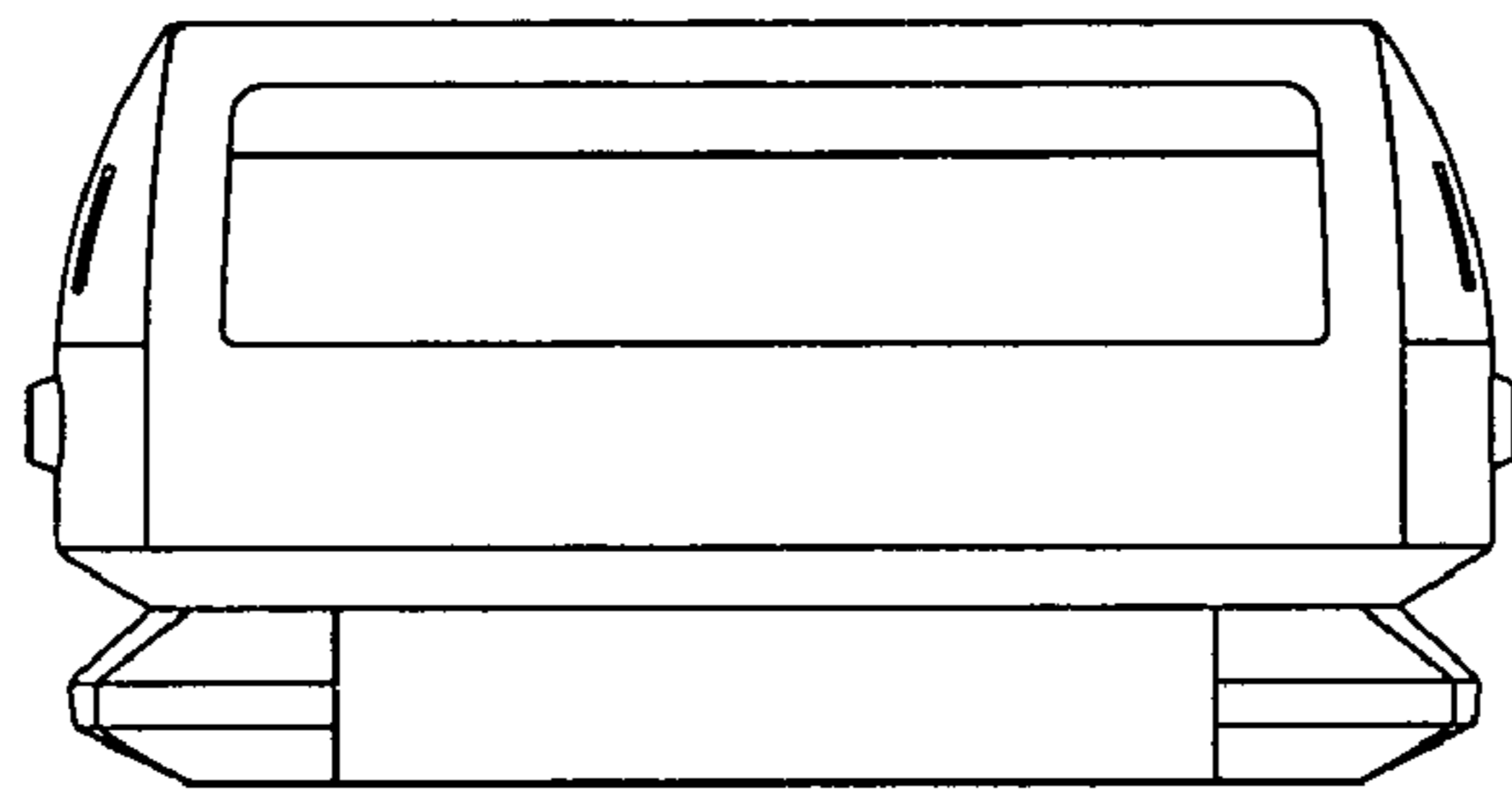

FIG. 7

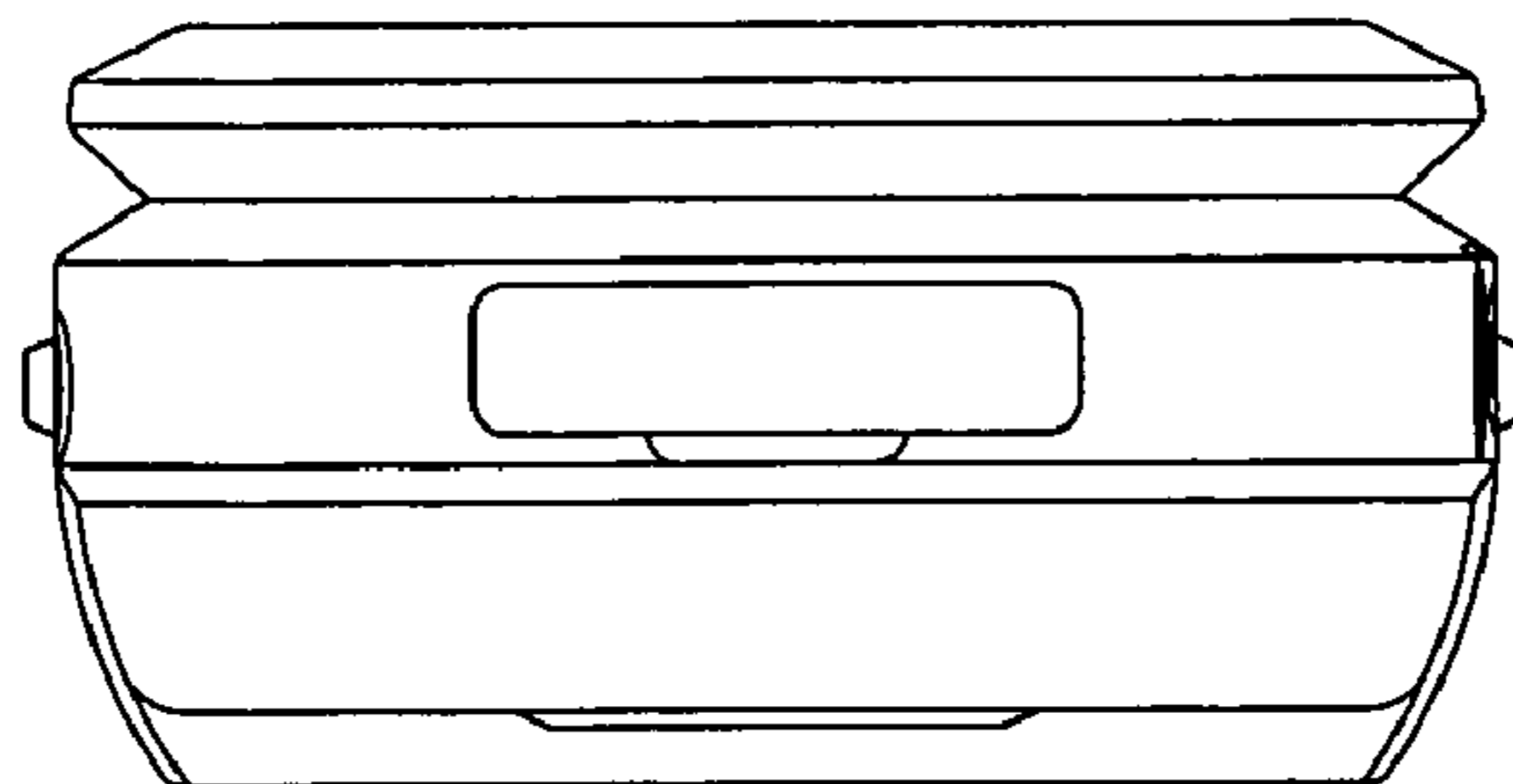

FIG. 8

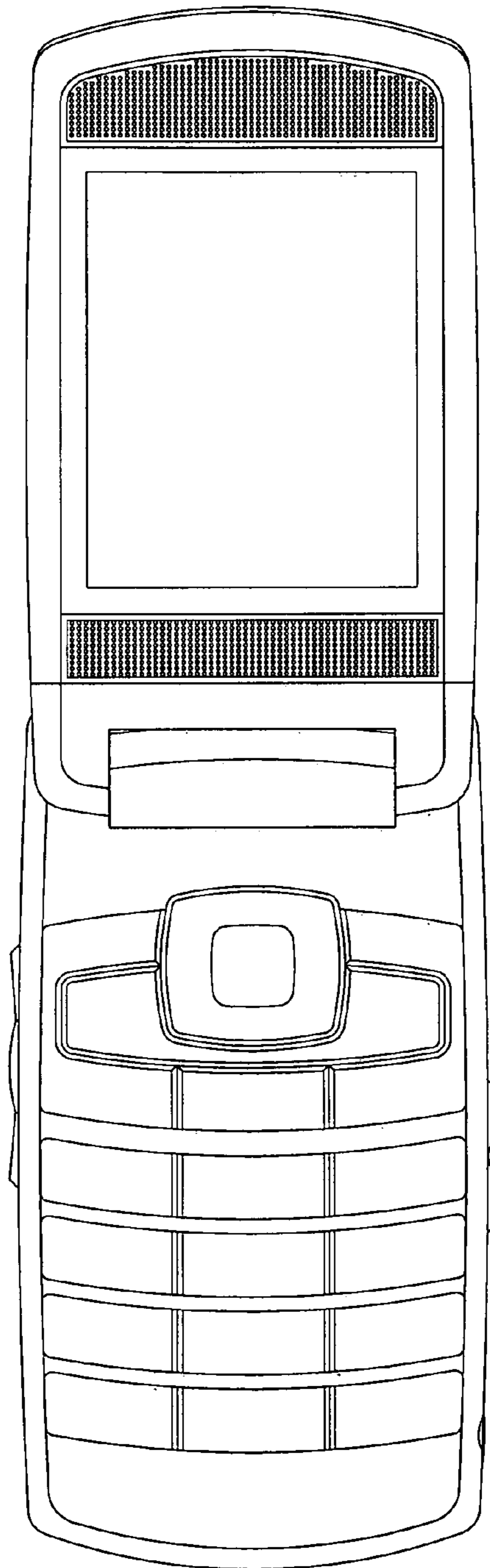

FIG. 9

