



US00D575253S

(12) **United States Design Patent**
Kuether et al.

(10) **Patent No.:** **US D575,253 S**
(45) **Date of Patent:** **** Aug. 19, 2008**

(54) **PORTABLE SATELLITE STATION COMBINATION**

Primary Examiner—Raphael Barkai
Assistant Examiner—Randall H Gholson

(75) Inventors: **David J. Kuether**, Brea, CA (US);
Steven M. Schein, Riverside, CA (US);
Rick Rosner, Marina del Rey, CA (US);
Joshua T. Morenstein, San Francisco, CA (US);
Pichaya Puttorngul, San Francisco, CA (US);
Naoya Edahiro, San Francisco, CA (US)

(57) **CLAIM**

The ornamental design for a “portable satellite station combination,” as shown and described.

(73) Assignee: **The DIRECTV Group, Inc.**, El Segundo, CA (US)

DESCRIPTION

(**) Term: **14 Years**

FIG. 1 is a perspective view of a portable satellite station in a closed position.

(21) Appl. No.: **29/271,004**

FIG. 2 is a top plan view of the closed portable satellite station combination of FIG. 1.

(22) Filed: **Jan. 6, 2007**

FIG. 3 is a bottom plan view of the closed portable satellite station combination of FIG. 1.

(51) **LOC (8) Cl.** **14-03**

FIG. 4 is a front view of the closed portable satellite station combination of FIG. 1.

(52) **U.S. Cl.** **D14/134**

FIG. 5 is a rear view of the closed portable satellite station combination of FIG. 1.

(58) **Field of Classification Search** D14/125–134,
D14/230–239, 371, 135, 136, 374–377, 138,
D14/299, 358, 155, 492, 356, 361–363, 365,
D14/496; 312/7.2, 208.1–223.2; 348/836,
348/838, 180, 184, 325, 739, 10, 460; 341/12;
248/465, 917–924, 123.11; 345/87, 104,
345/133, 156, 168, 169, 173; 720/605, 669,
720/600, 655, 99, 197; 369/99, 197; 455/344–347,
455/90.2, 90.3, 91, 128, 269, 562.1; 349/1,
349/2, 11, 62; D12/42, 43; 343/700, 871–908,
343/795, 840, 711–713, 819, 846; 361/690,
361/696

FIG. 6 is a right side view of the closed portable satellite station combination of FIG. 1.

FIG. 7 is a left side view of the closed portable satellite station combination of FIG. 1.

FIG. 8 is a perspective view of the portable satellite station combination of FIG. 1 in an open position.

FIG. 9 is a top plan view of the open portable satellite station combination of FIG. 8.

FIG. 10 is a bottom plan view of the open portable satellite station combination of FIG. 8.

FIG. 11 is a rear view of the open portable satellite station combination of FIG. 8.

FIG. 12 is a front view of the open portable satellite station combination of FIG. 8.

FIG. 13 is a right view of the open portable satellite station combination of FIG. 8; and,

FIG. 14 is a left view of the open portable satellite station combination of FIG. 8.

See application file for complete search history.

(56) **References Cited**

U.S. PATENT DOCUMENTS

4,809,078	A	*	2/1989	Yabe et al.	348/794
D306,581	S	*	3/1990	Kautz	D14/126
D310,671	S	*	9/1990	Weiss	D14/230
D321,883	S	*	11/1991	Borchardt	D14/230

(Continued)

1 Claim, 11 Drawing Sheets

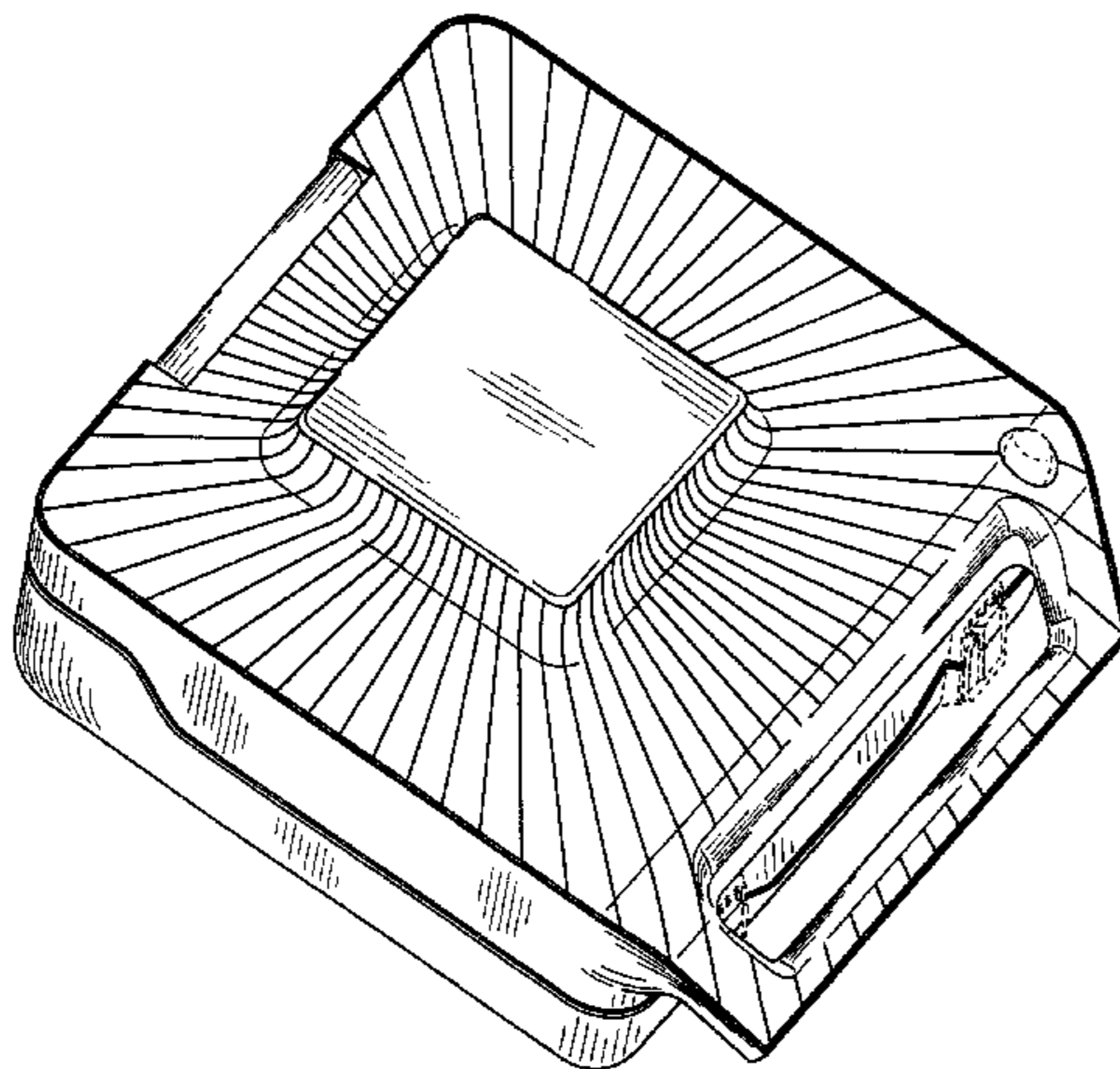

US D575,253 S

Page 2

U.S. PATENT DOCUMENTS

D347,010 S *	5/1994	Emmerling	D14/230	D434,399 S *	11/2000	Lanet	D14/130
5,701,904 A *	12/1997	Simmons et al.	600/301	D542,751 S *	5/2007	Guo et al.	D14/132
D418,839 S *	1/2000	Brunner et al.	D14/230	2006/0258440 A1 *	11/2006	Vitito	463/29
					2006/0288380 A1 *	12/2006	Vitito	725/77

* cited by examiner

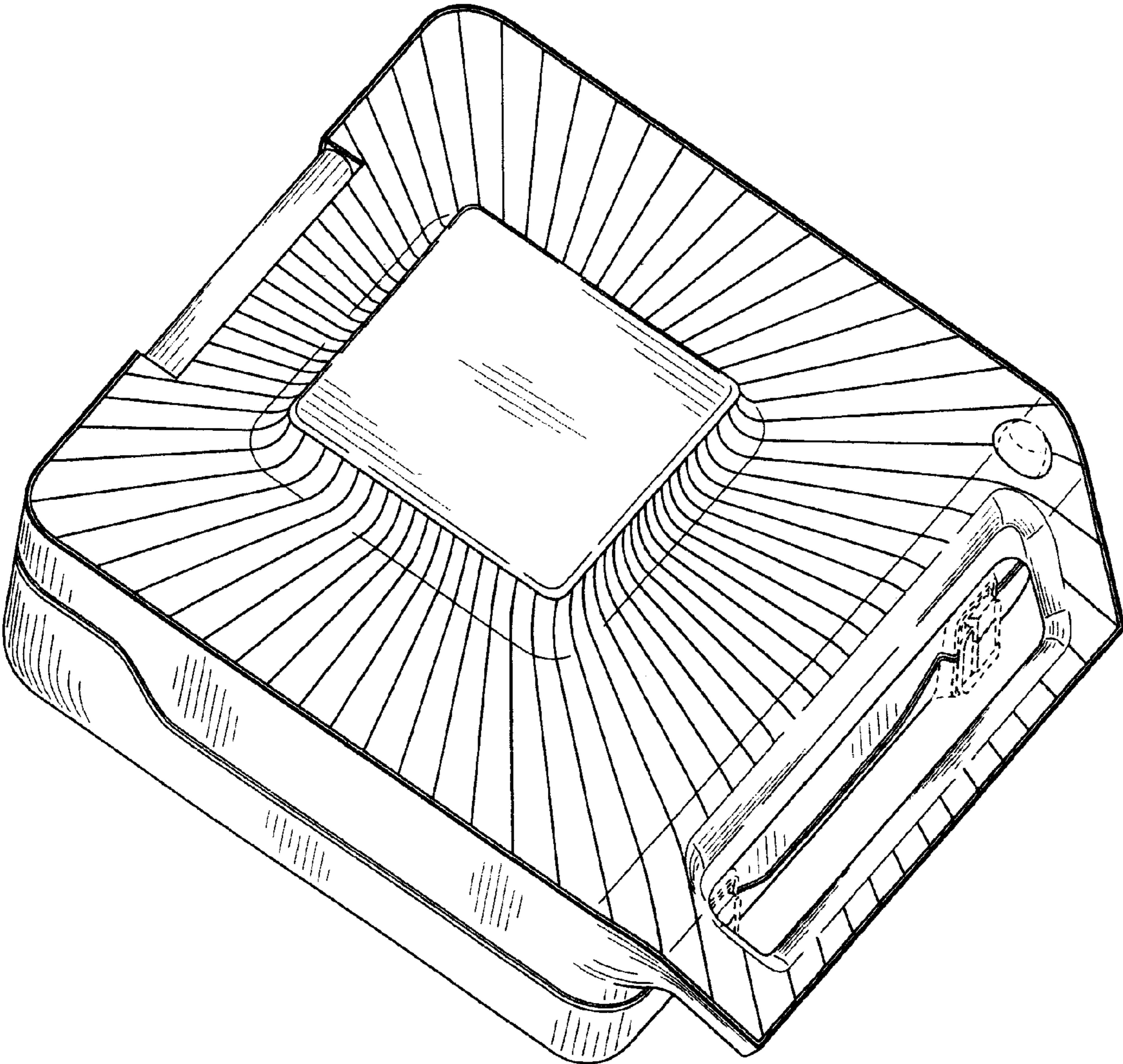

FIG. 1

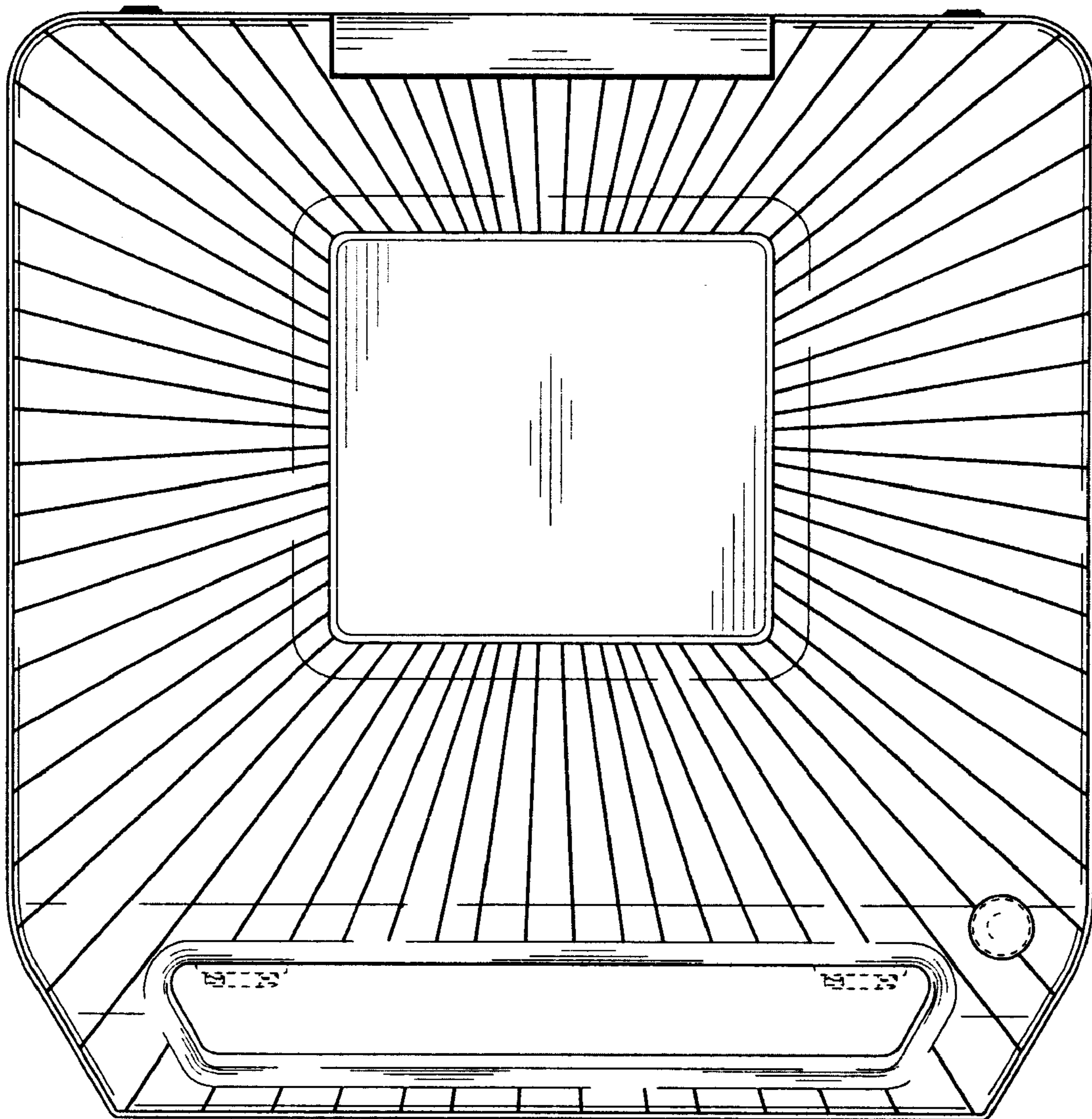

FIG. 2

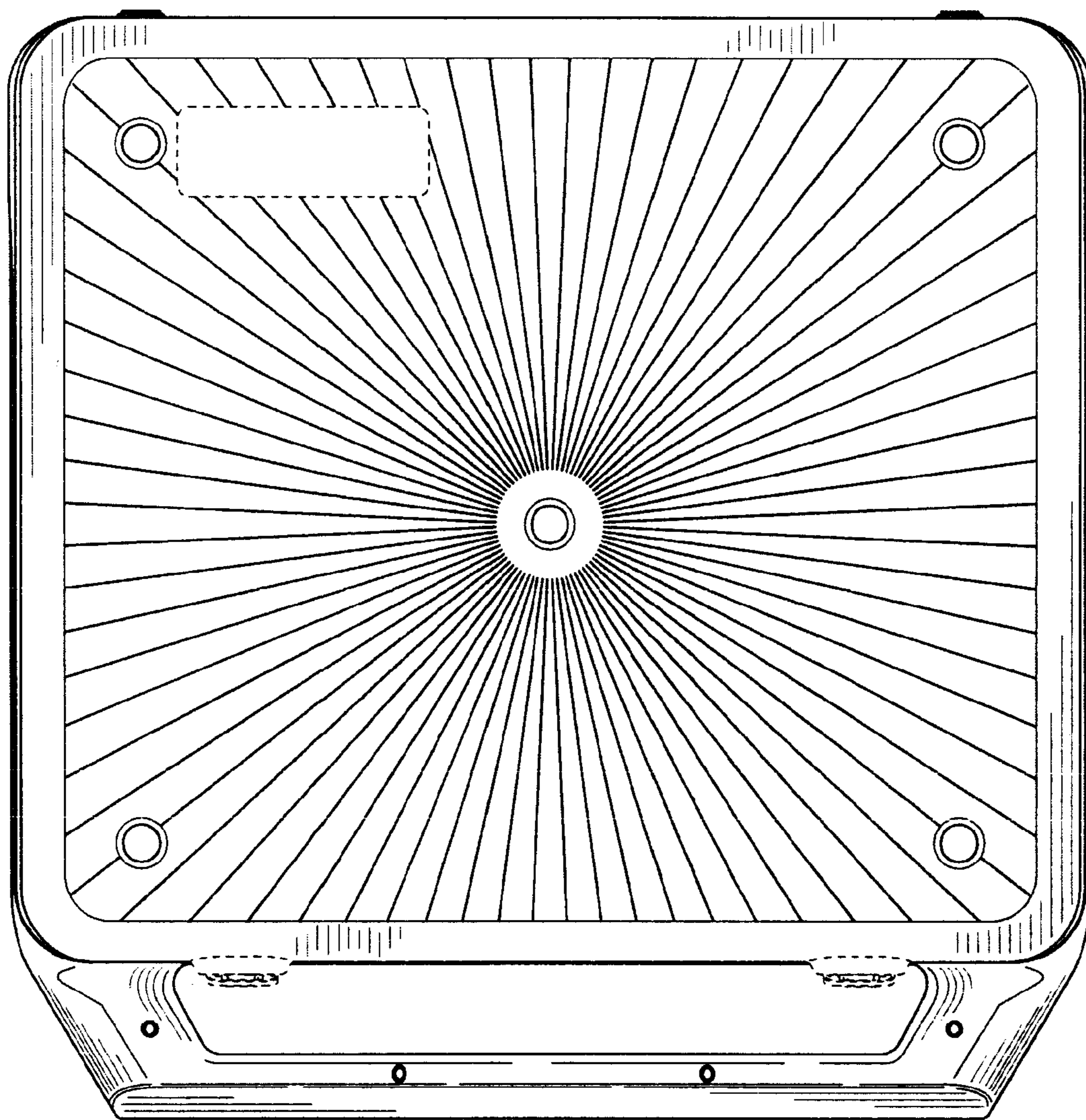

FIG. 3

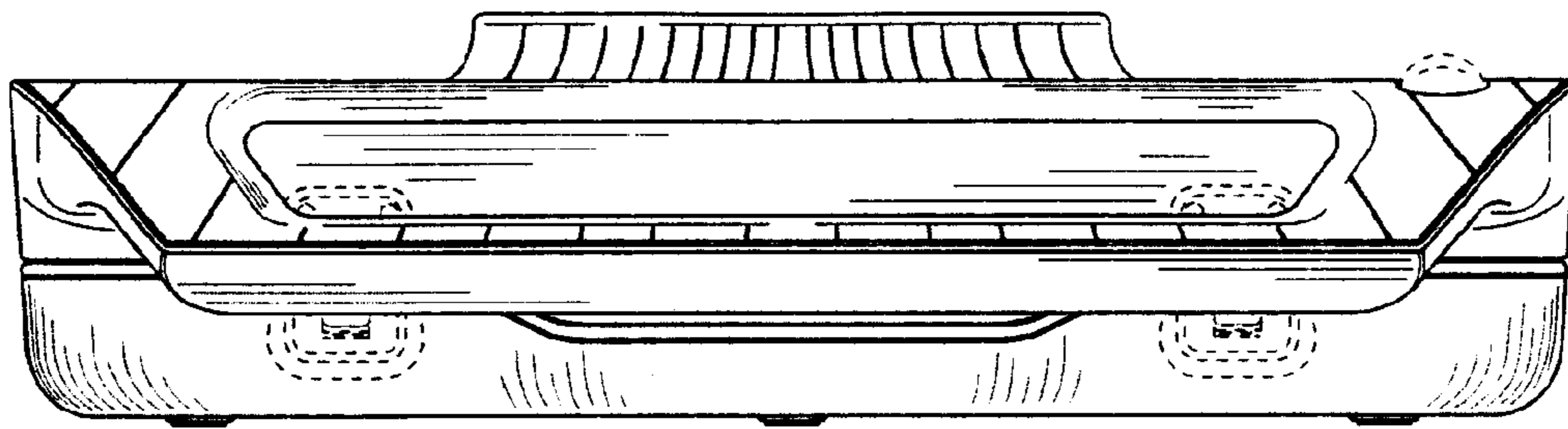

FIG. 4

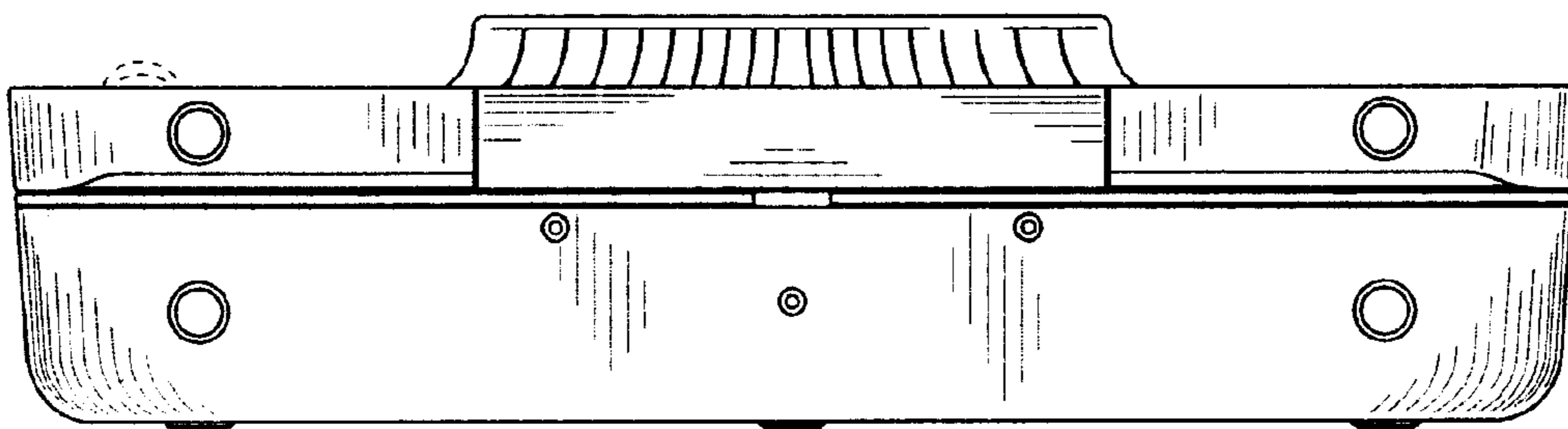

FIG. 5

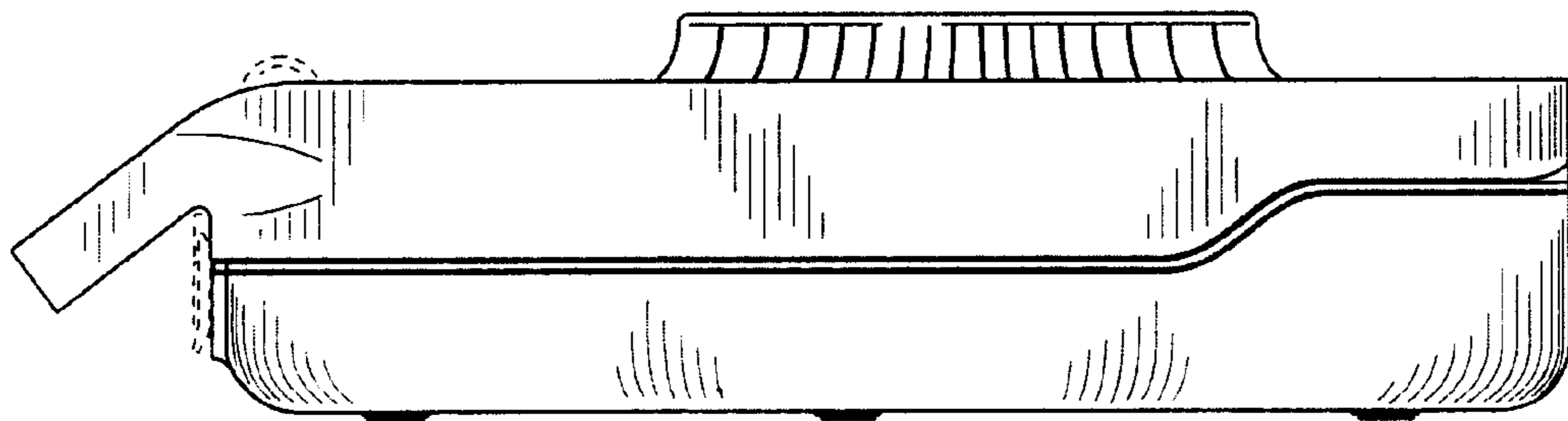

FIG. 6

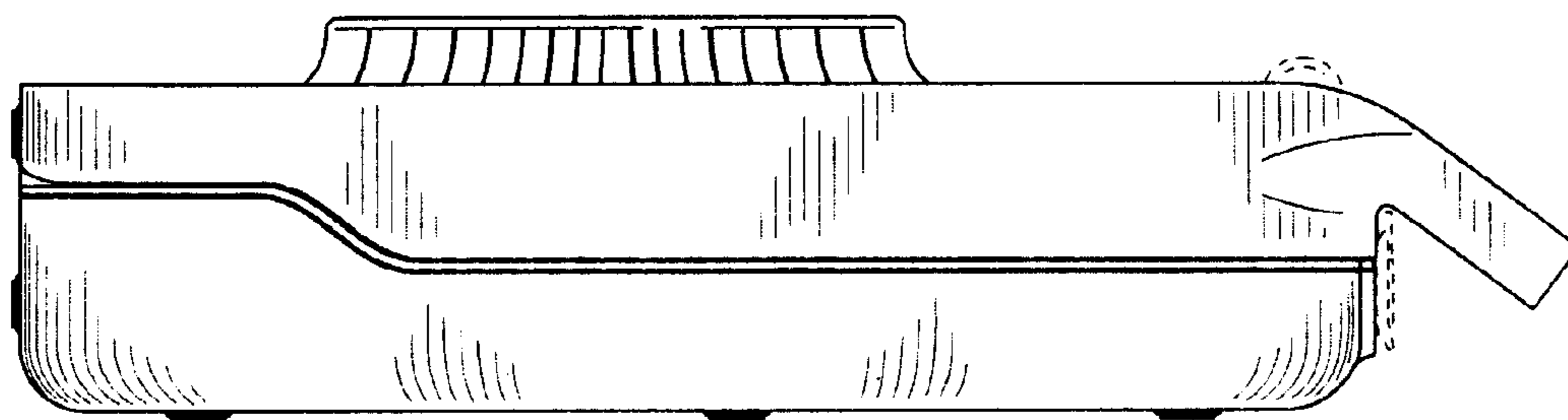

FIG. 7

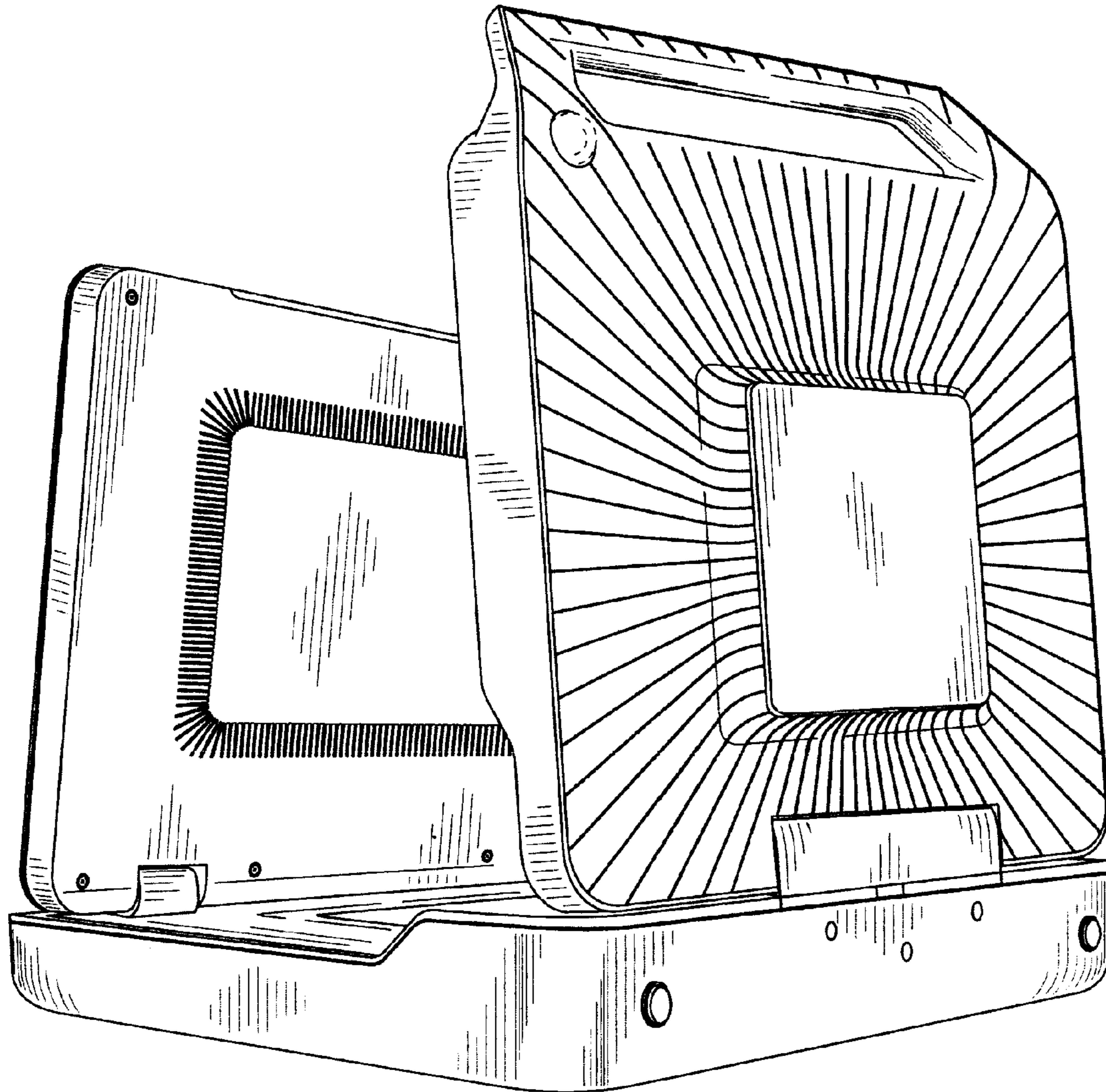

FIG. 8

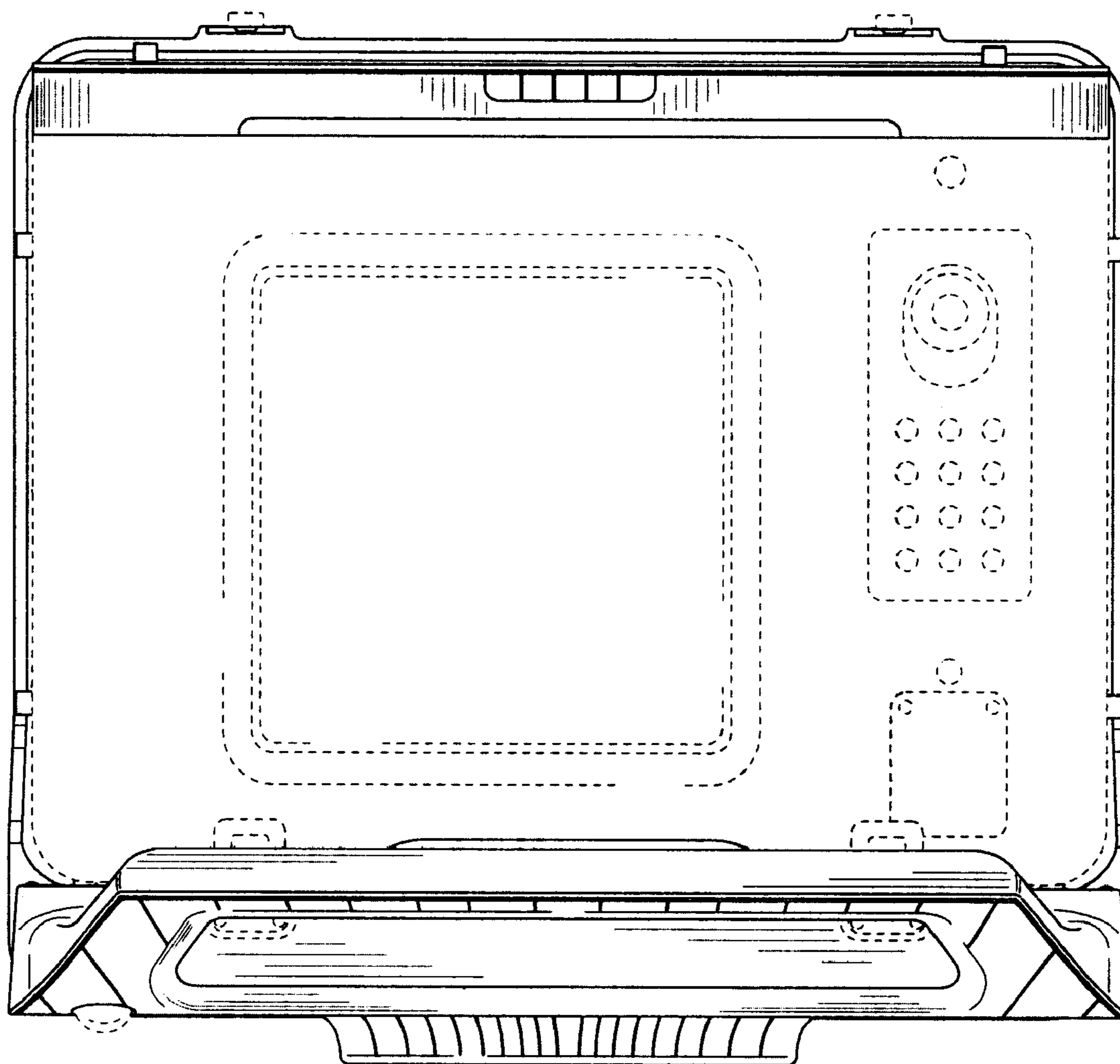

FIG. 9

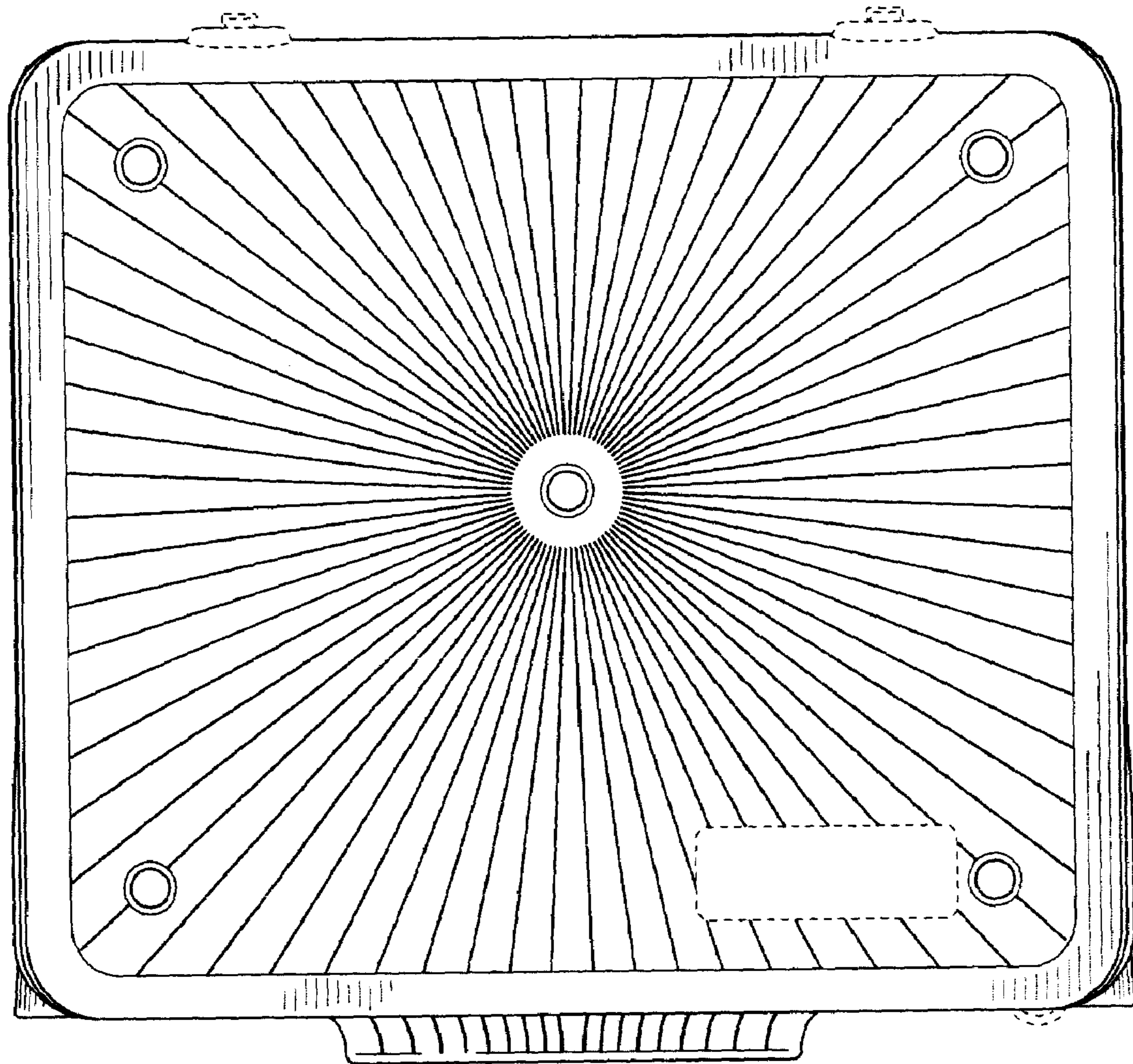

FIG. 10

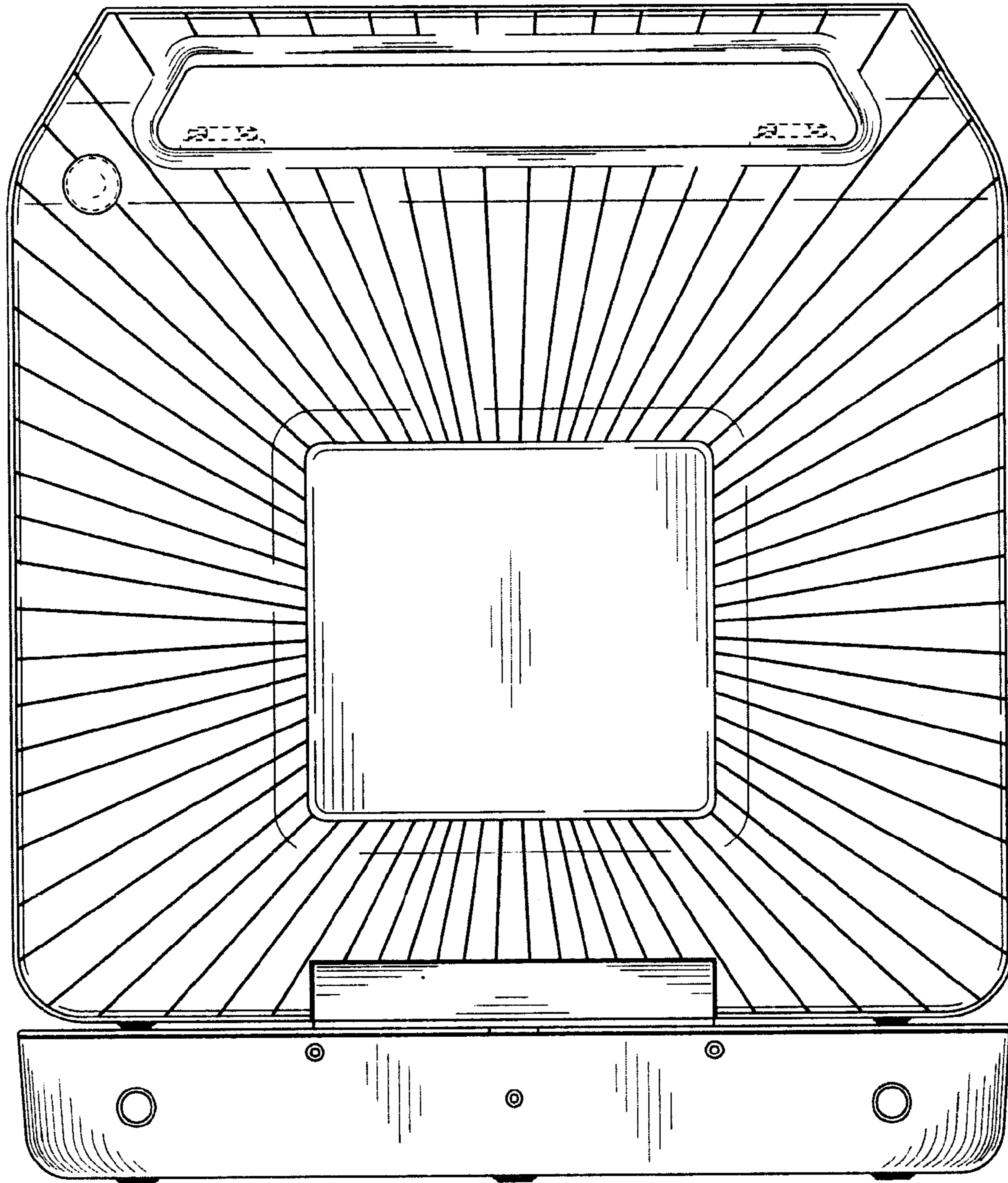

FIG. 11

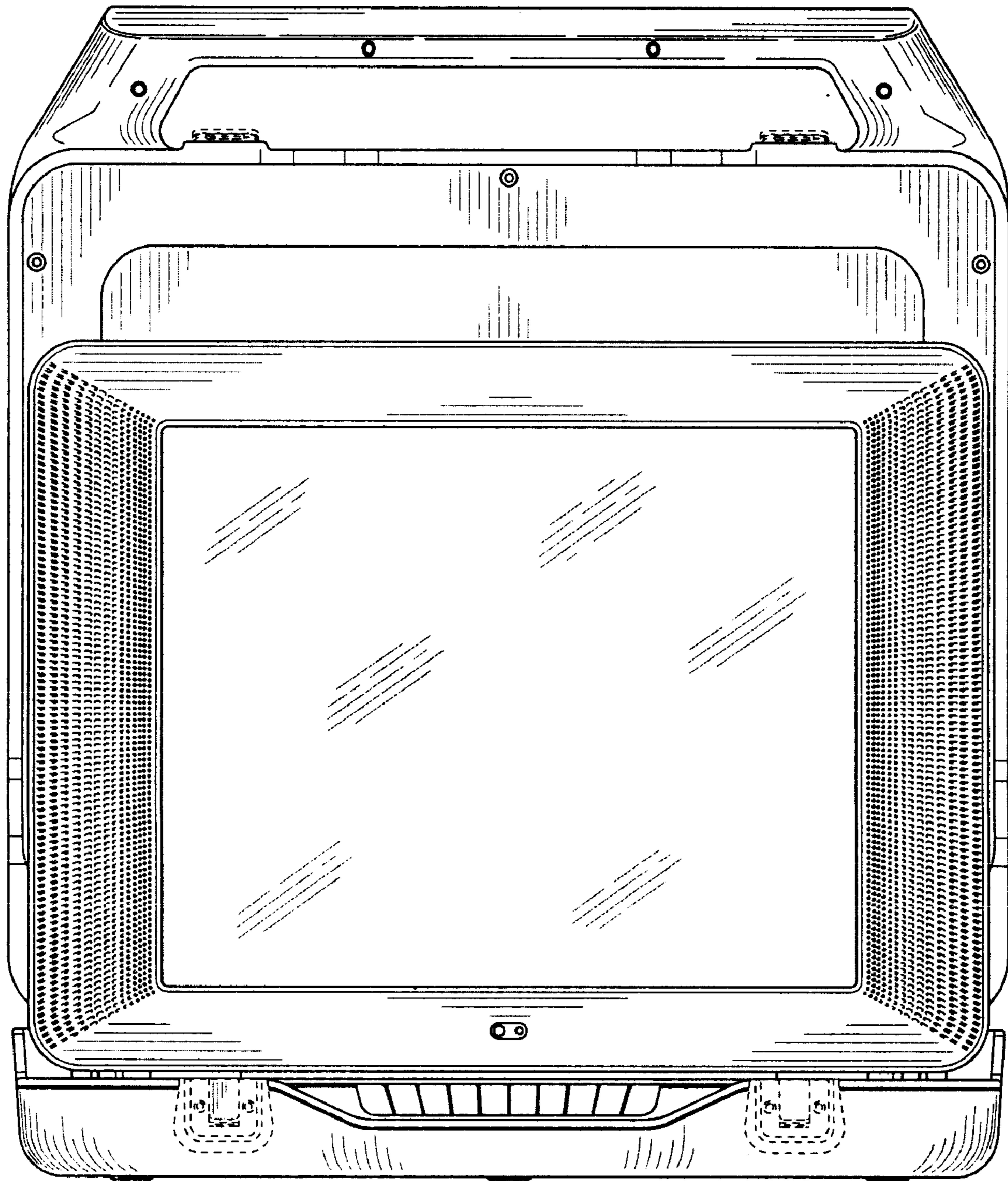

FIG. 12

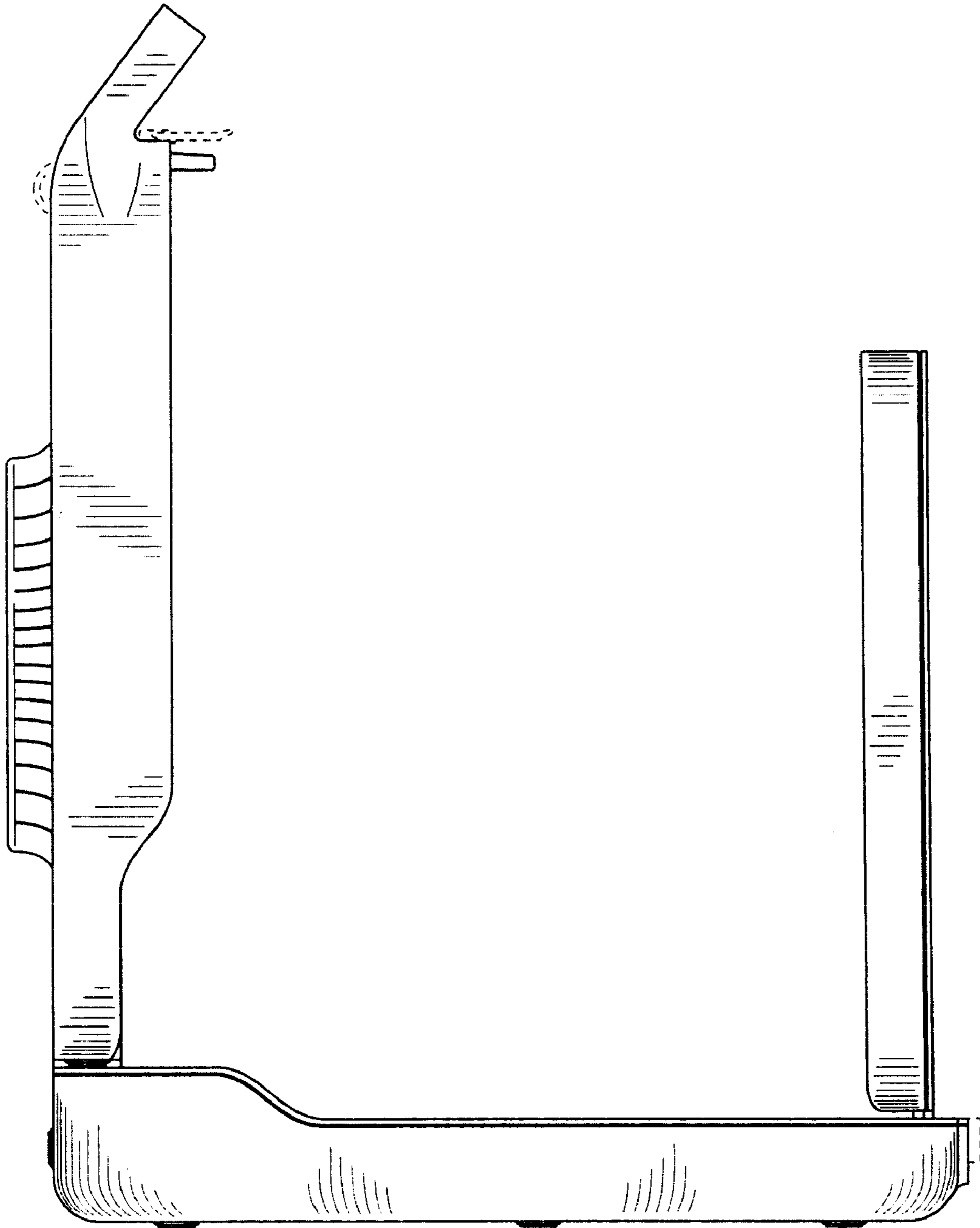

FIG. 13

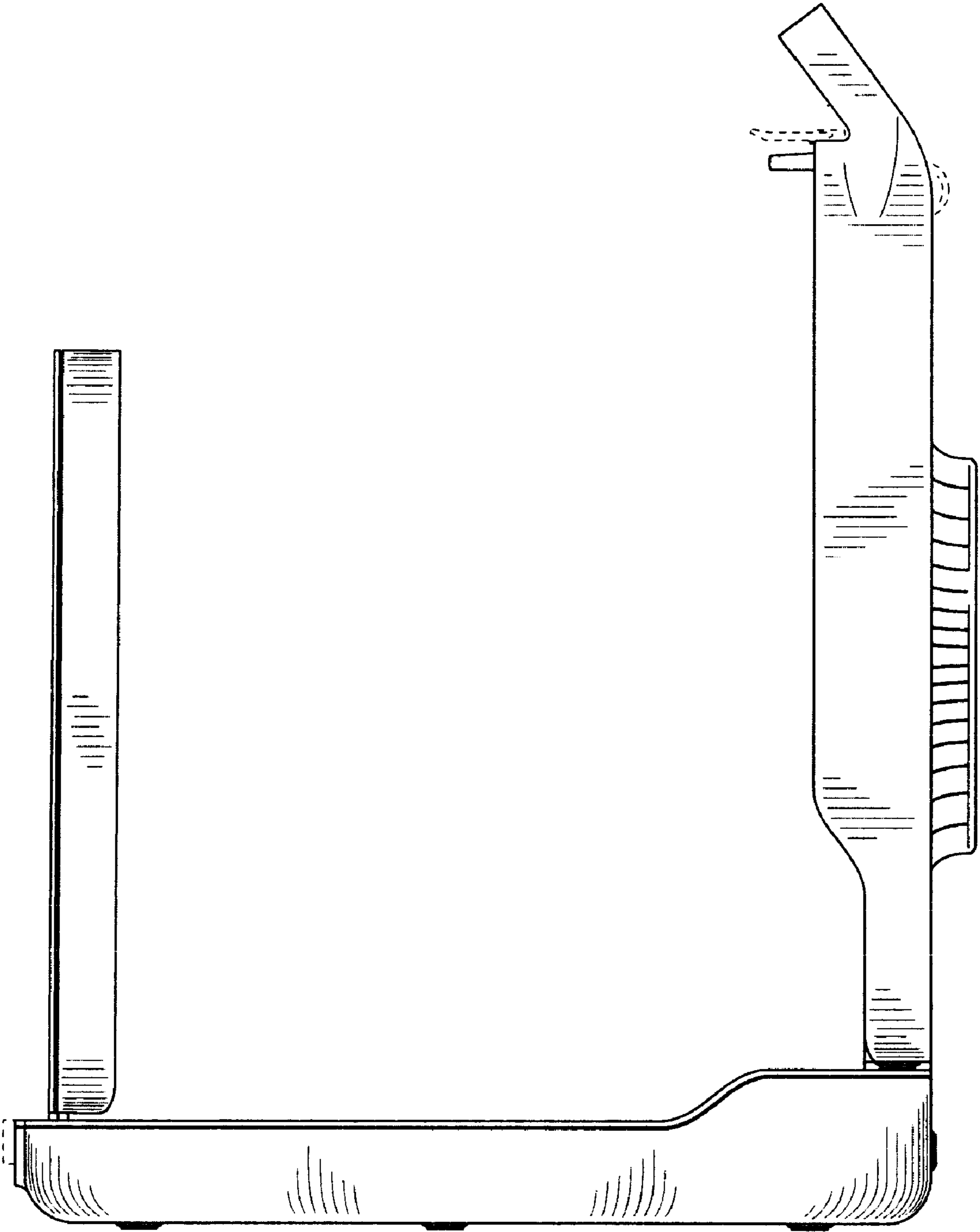

FIG. 14