

US00D575194S

(12) **United States Design Patent**  
**Hishiki**

(10) **Patent No.:** **US D575,194 S**

(45) **Date of Patent:** **\*\* Aug. 19, 2008**

(54) **HEADLIGHT COVER FOR A SNOWMOBILE**

(75) Inventor: **Hiroyuki Hishiki**, Tokyo-to (JP)

(73) Assignee: **Yamaha Hatsudoki Kabushiki Kaisha**,  
Shizuoka-ken (JP)

(\*\*) Term: **14 Years**

(21) Appl. No.: **29/245,988**

(22) Filed: **Dec. 30, 2005**

(51) **LOC (8) Cl.** ..... **12-14**

(52) **U.S. Cl.** ..... **D12/7**

(58) **Field of Classification Search** ..... D12/7,  
D12/110, 111, 9, 112, 307, 182, 86, 85, 88;  
362/459-469; 180/220, 225, 229, 219, 9.25,  
180/180; D26/28-36

See application file for complete search history.

(56) **References Cited**

**U.S. PATENT DOCUMENTS**

D500,564 S \* 1/2005 Uemoto et al. .... D26/28  
D526,075 S \* 8/2006 Kudo et al. .... D26/28  
D531,090 S \* 10/2006 Iimura ..... D12/110

\* cited by examiner

*Primary Examiner*—Robert M. Spear

*Assistant Examiner*—Ania K Dworzecka

(74) *Attorney, Agent, or Firm*—Knobbe Martens Olson &  
Bear LLP

(57) **CLAIM**

The ornamental design for a headlight cover for a snowmo-  
bile, as shown and described.

**DESCRIPTION**

FIG. 1 is a front right perspective view of a headlight cover for  
a snowmobile;

FIG. 2 is another front right perspective view thereof;

FIG. 3 is a rear left perspective view thereof;

FIG. 4 is a right side view thereof;

FIG. 5 is a left side view thereof;

FIG. 6 is a front view thereof; and,

FIG. 7 is a top view thereof.

The broken line showing a snowmobile is included for the  
purpose of illustrating only and forms no part of the claimed  
design.

**1 Claim, 5 Drawing Sheets**

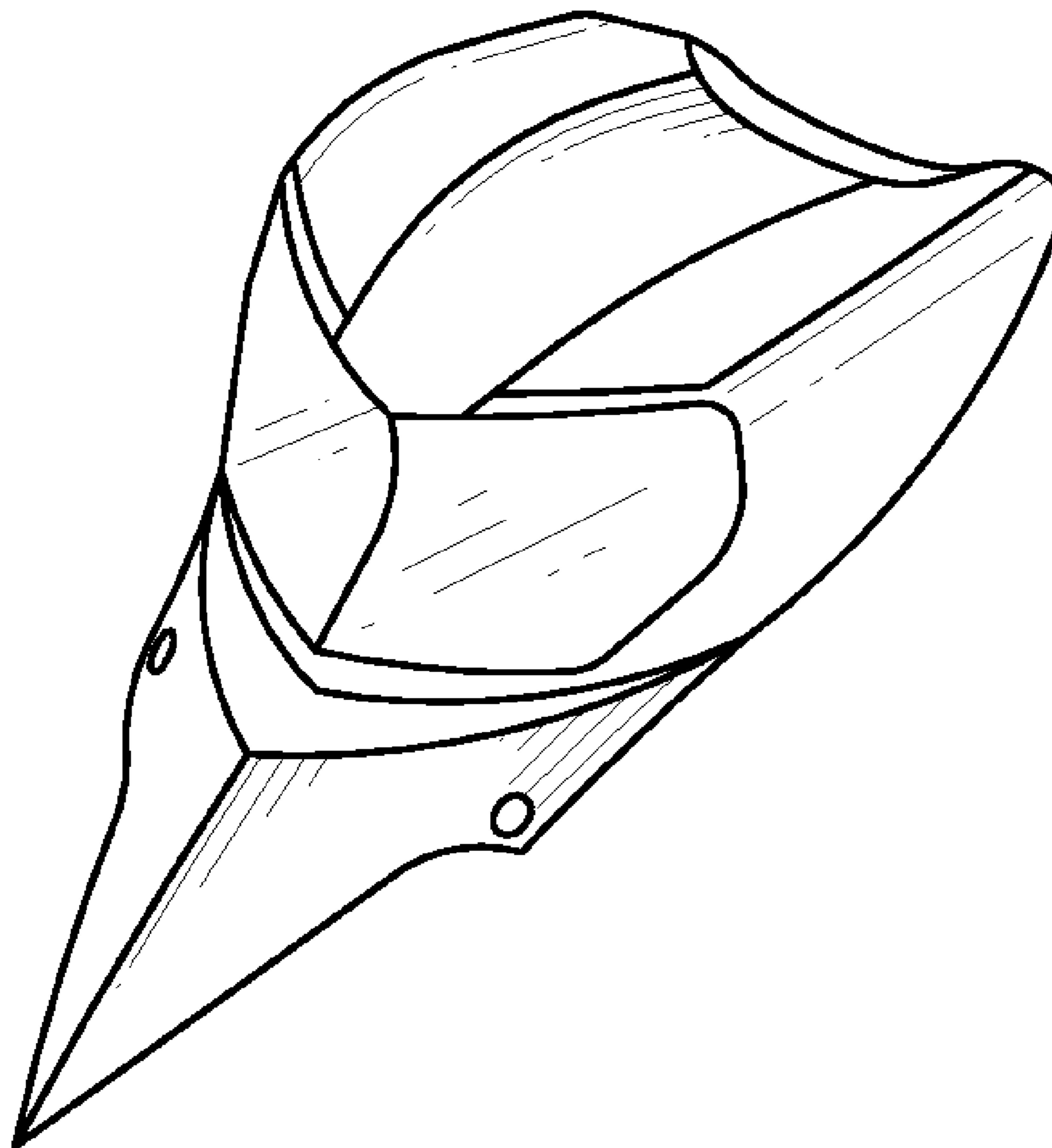

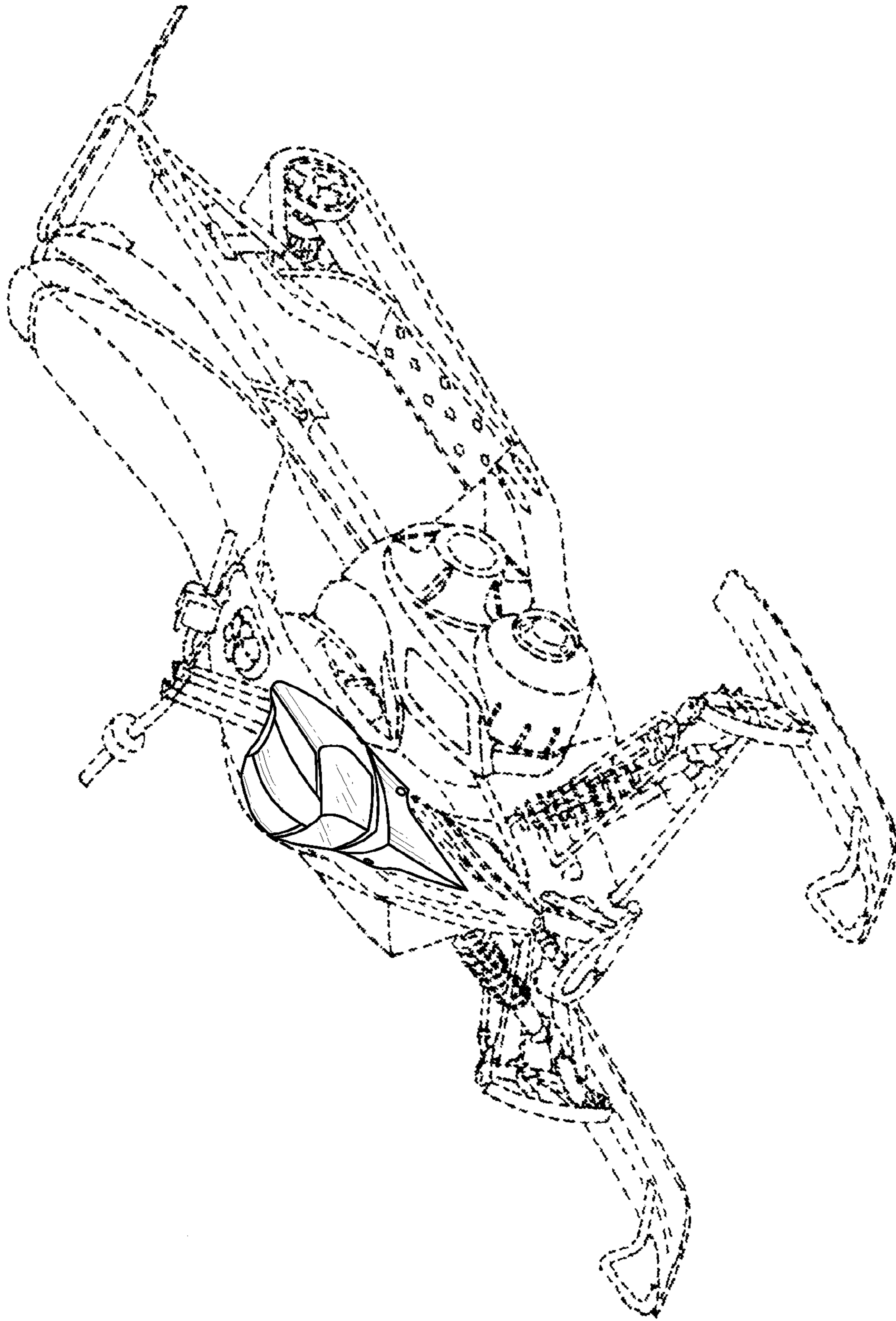

FIG. 1

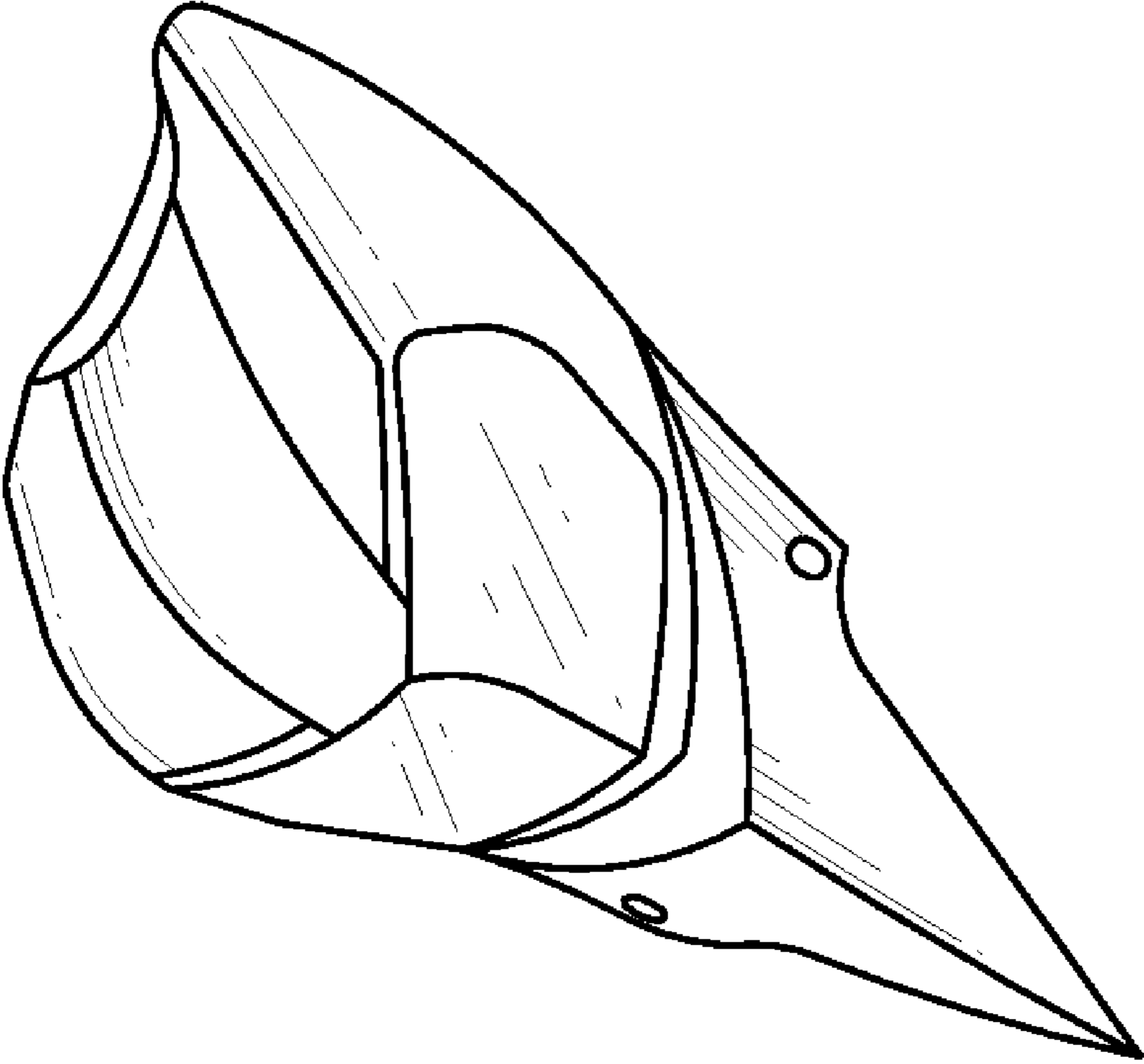

FIG. 2

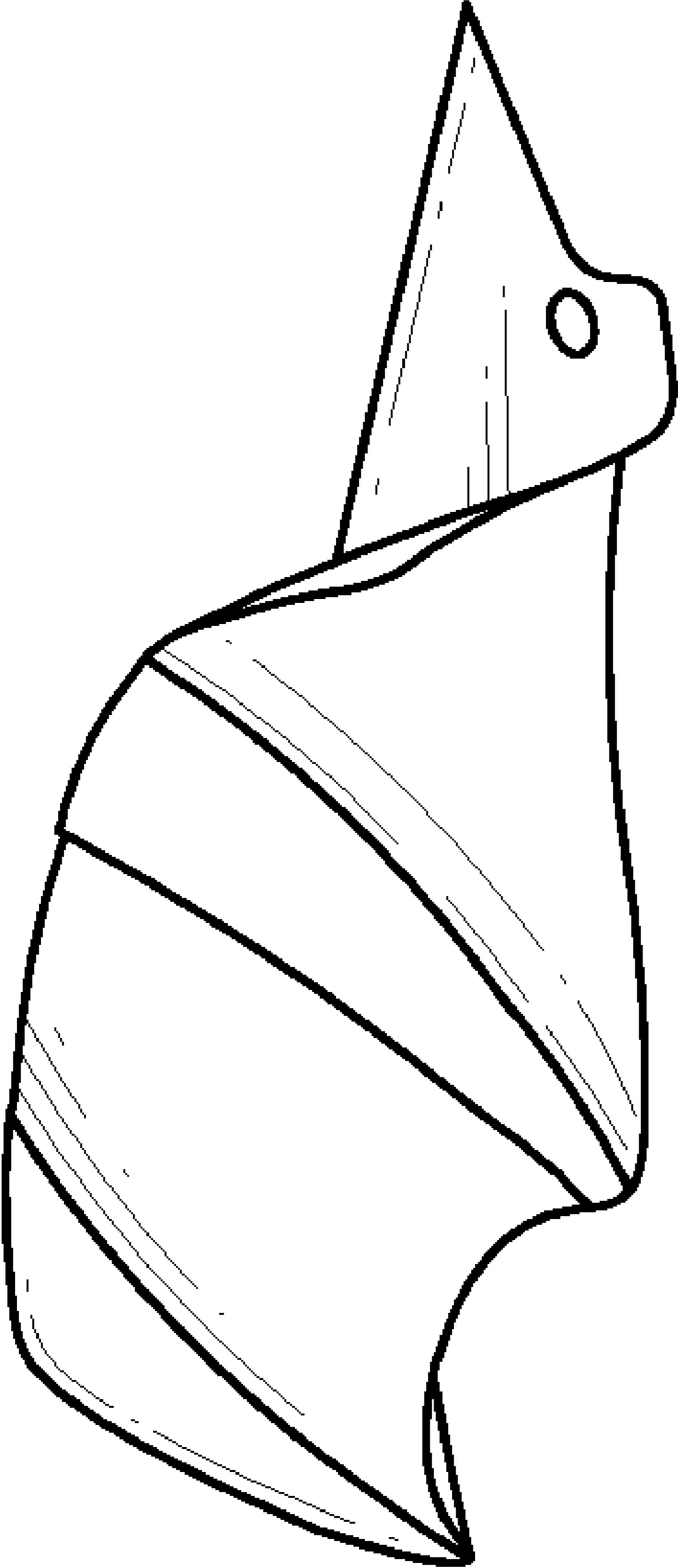

FIG. 3

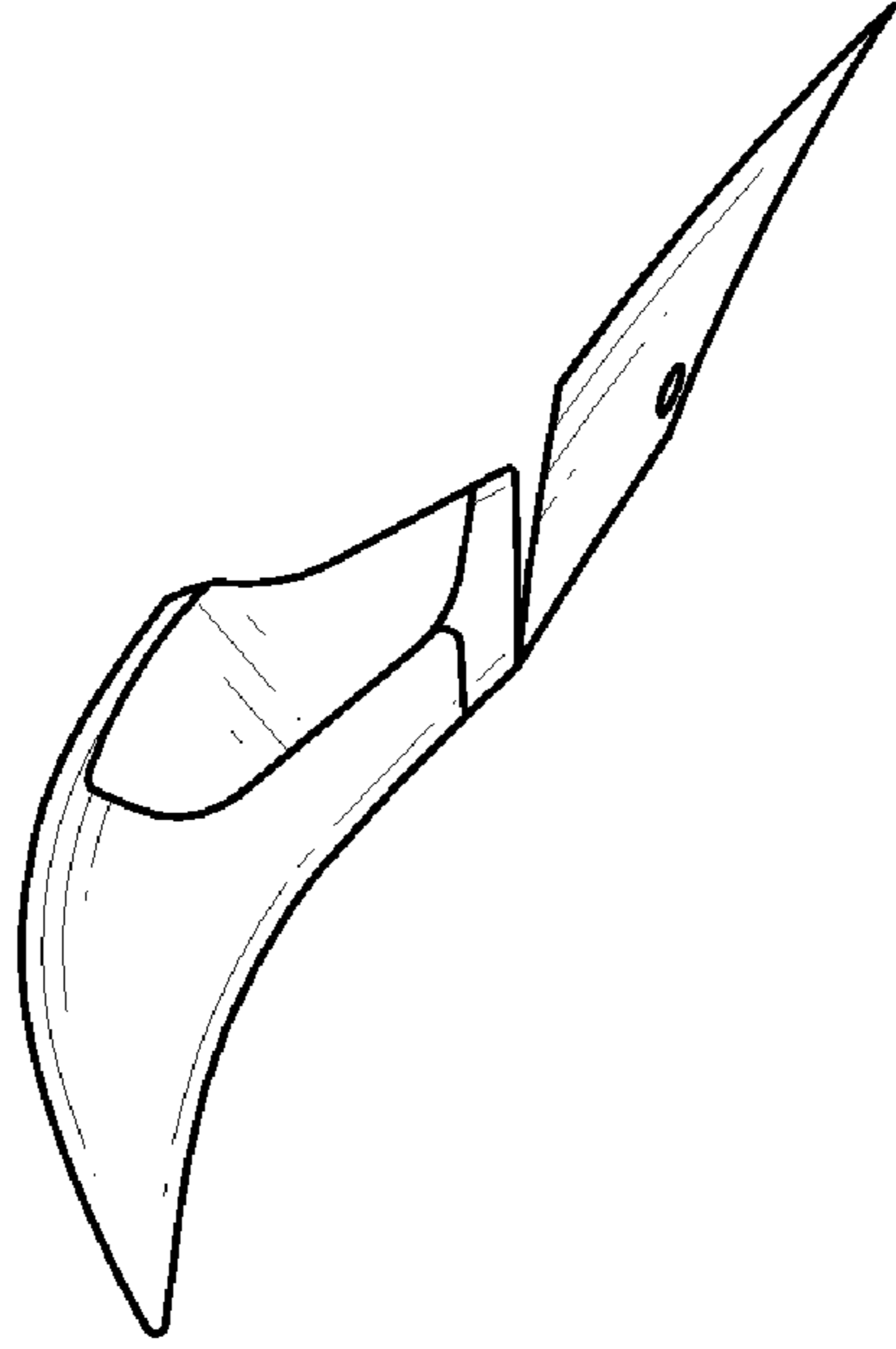

FIG. 5

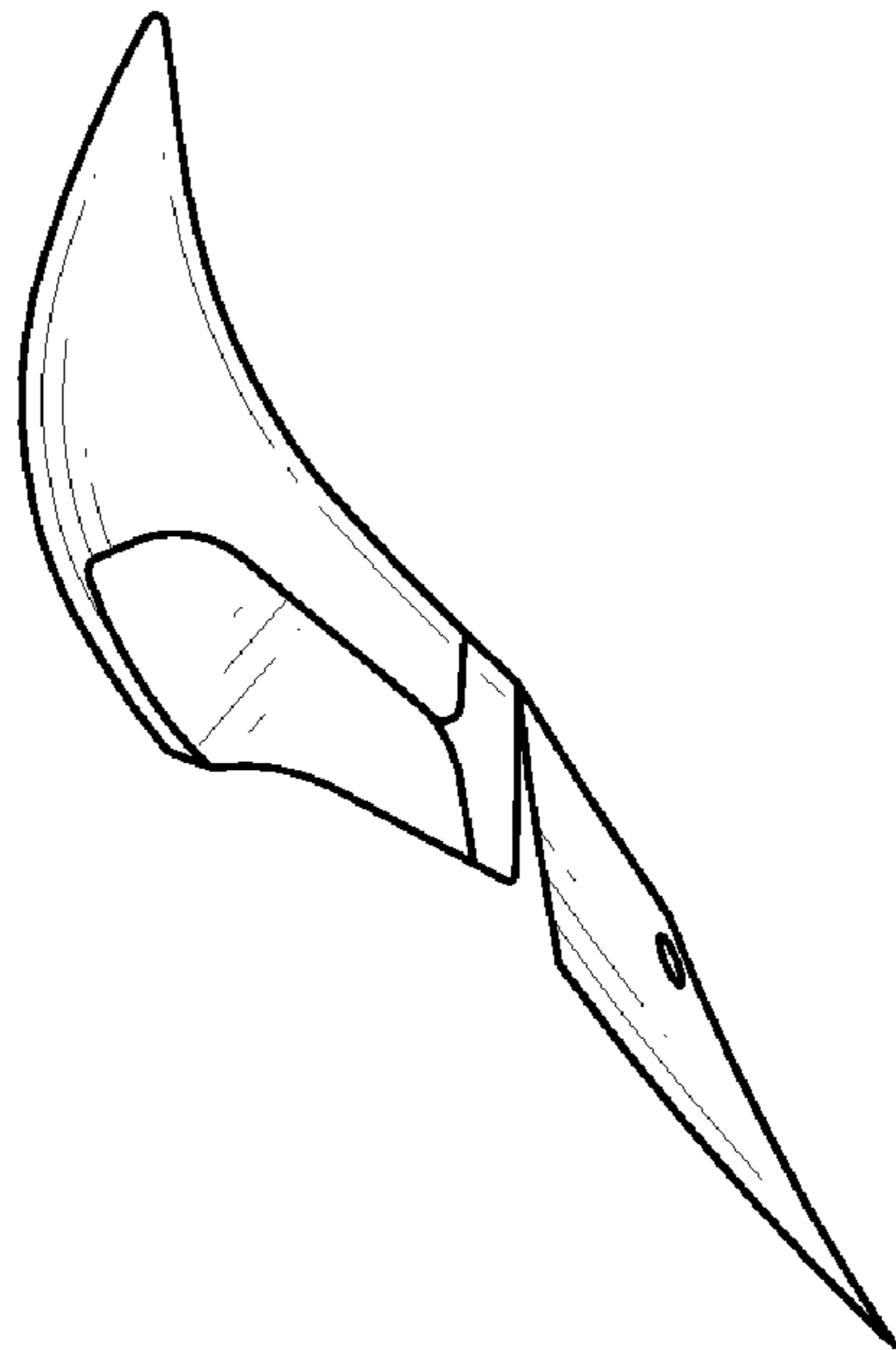

FIG. 4

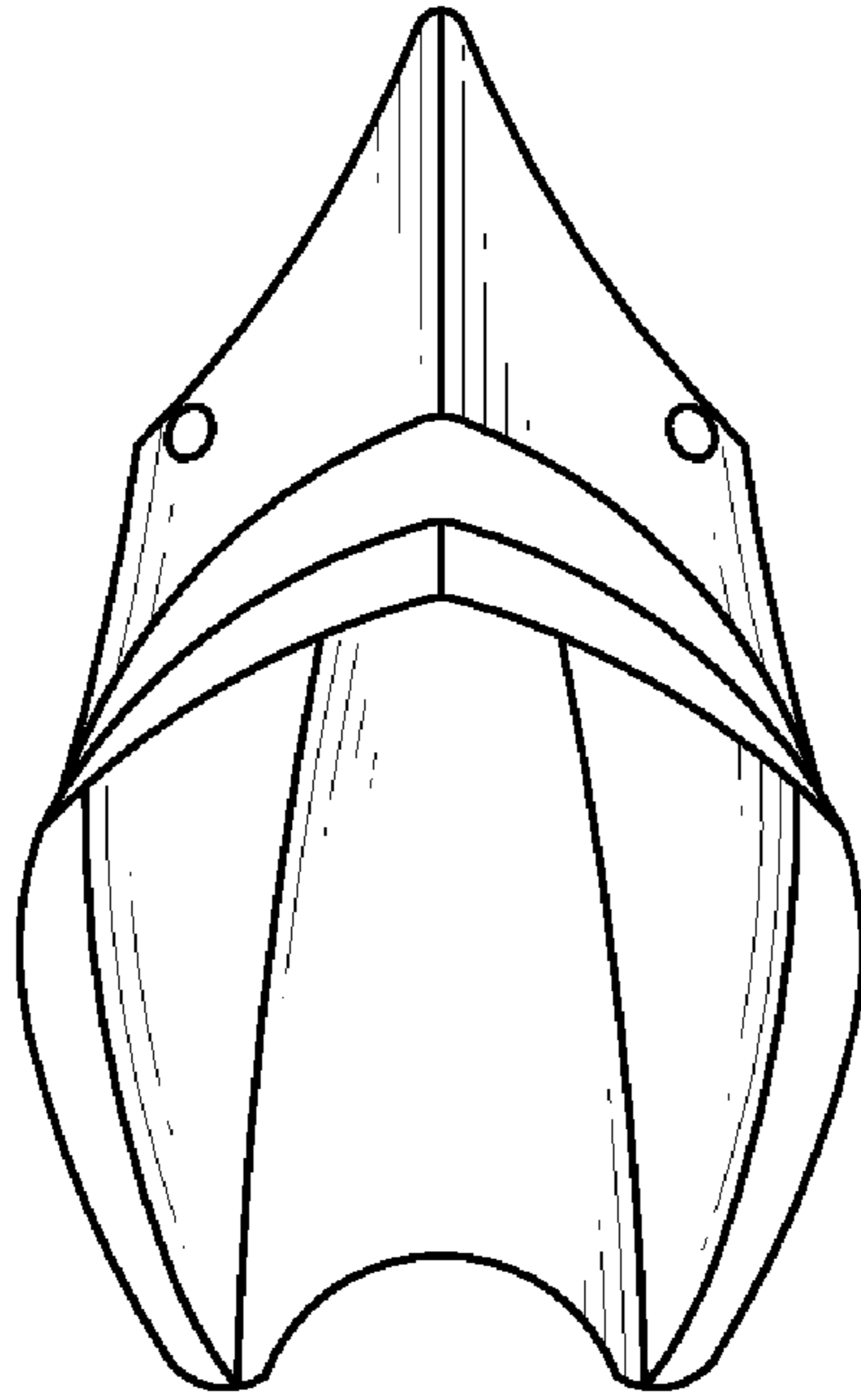

FIG. 7

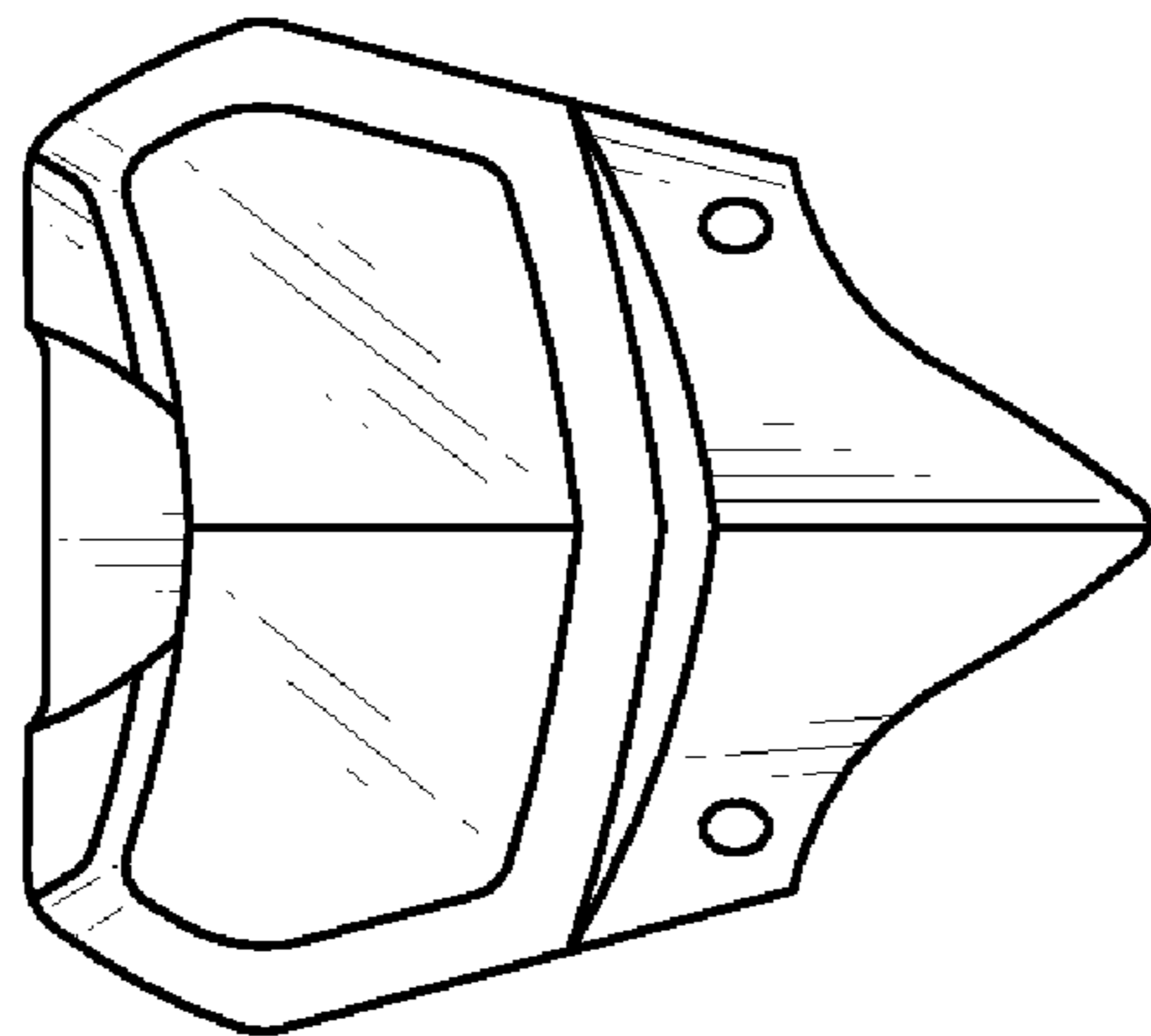

FIG. 6