



US00D575134S

(12) **United States Design Patent**
Sheppard

(10) **Patent No.:** **US D575,134 S**

(45) **Date of Patent:** **** Aug. 19, 2008**

(54) **QUARTER HANDLE**

(75) Inventor: **Peter Ralph Sheppard**, London (GB)

(73) Assignee: **Smallbone & Co. (Devizes) Limited**,
Devizes, Wiltshire (GB)

(**) Term: **14 Years**

(21) Appl. No.: **29/247,990**

(22) Filed: **Jul. 24, 2006**

(30) **Foreign Application Priority Data**

Jan. 31, 2006 (GB) 3023815

Jan. 31, 2006 (GB) 3023816

(51) **LOC (8) Cl.** **08-06**

(52) **U.S. Cl.** **D8/313; D6/300**

(58) **Field of Classification Search** D8/300,
D8/313, 314, 315, 317, 319, 305, DIG. 1;
D6/510; D25/119, 61, 102, 116, 117, 136;
16/415, 416; 24/336, 16 R; 52/717.03; 312/334.44,
312/348.6, 320; 224/482

See application file for complete search history.

(56) **References Cited**

U.S. PATENT DOCUMENTS

324,942 A * 8/1885 Knapp 428/122

1,497,163 A * 6/1924 Van Der Pyl 52/179

(Continued)

Primary Examiner—Paula A Greene

(74) *Attorney, Agent, or Firm*—Alston & Bird LLP

(57) **CLAIM**

The ornamental design for a quarter handle, as shown and described.

DESCRIPTION

FIG. 1 is a front perspective view of a quarter handle according to an embodiment of the present invention;

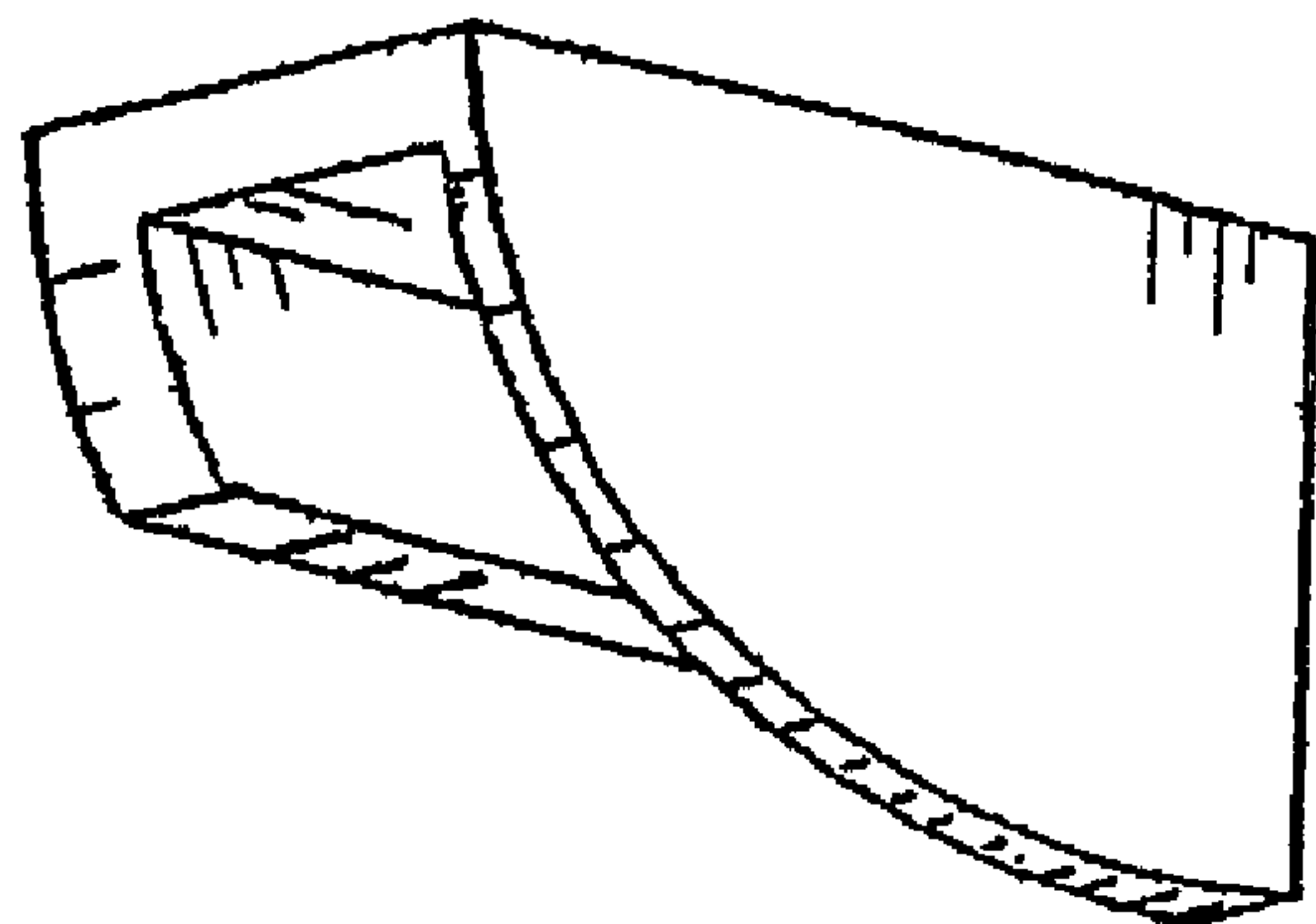

FIG. 2 is a rear perspective view of the quarter handle shown in FIG. 1;

FIG. 3 is a left side plan view of the quarter handle shown in FIG. 1;

FIG. 4 is a right side plan view of the quarter handle shown in FIG. 1;

FIG. 5 is a rear plan view of the quarter handle shown in FIG. 1;

FIG. 6 is a front plan view of the quarter handle shown in FIG. 1;

FIG. 7 is a top plan view of the quarter handle shown in FIG. 1;

FIG. 8 is a bottom plan view of the quarter handle shown in FIG. 1;

FIG. 9 is a front perspective view of a quarter handle according to another embodiment of the present invention;

FIG. 10 is a rear perspective view of the quarter handle shown in FIG. 9;

FIG. 11 is a right side plan view of the quarter handle shown in FIG. 9;

FIG. 12 is a left side plan view of the quarter handle shown in FIG. 9;

FIG. 13 is a rear plan view of the quarter handle shown in FIG. 9;

FIG. 14 is a front plan view of the quarter handle shown in FIG. 9;

FIG. 15 is a top plan view of the quarter handle shown in FIG. 9; and,

FIG. 16 is a bottom plan view of the quarter handle shown in FIG. 9.

The broken lines are included for the purpose of illustration and form no part of the claimed design.

1 Claim, 5 Drawing Sheets

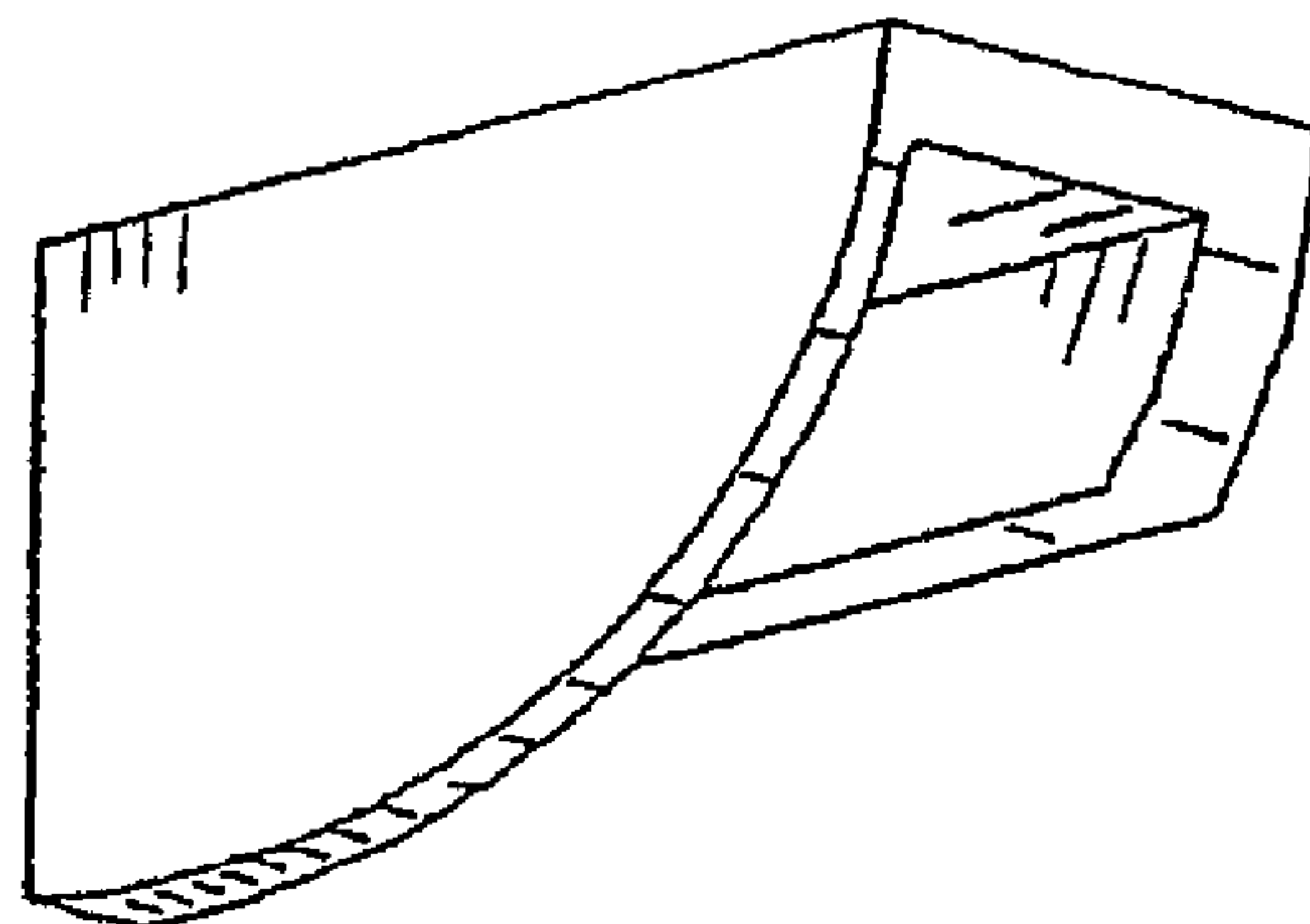

US D575,134 S

Page 2

U.S. PATENT DOCUMENTS

1,747,339	A *	2/1930	Walper	428/122	D411,793	S *	7/1999	O'Neil	D8/305
D96,330	S *	7/1935	Martin	D8/314	5,997,118	A *	12/1999	McBrayer et al.	312/334.44
2,149,742	A *	3/1939	Miller	52/717.03	D457,800	S *	5/2002	Petri	D8/313
D402,143	S *	12/1998	Zapf	D6/510	D529,630	S *	10/2006	Zarb	D25/119

* cited by examiner

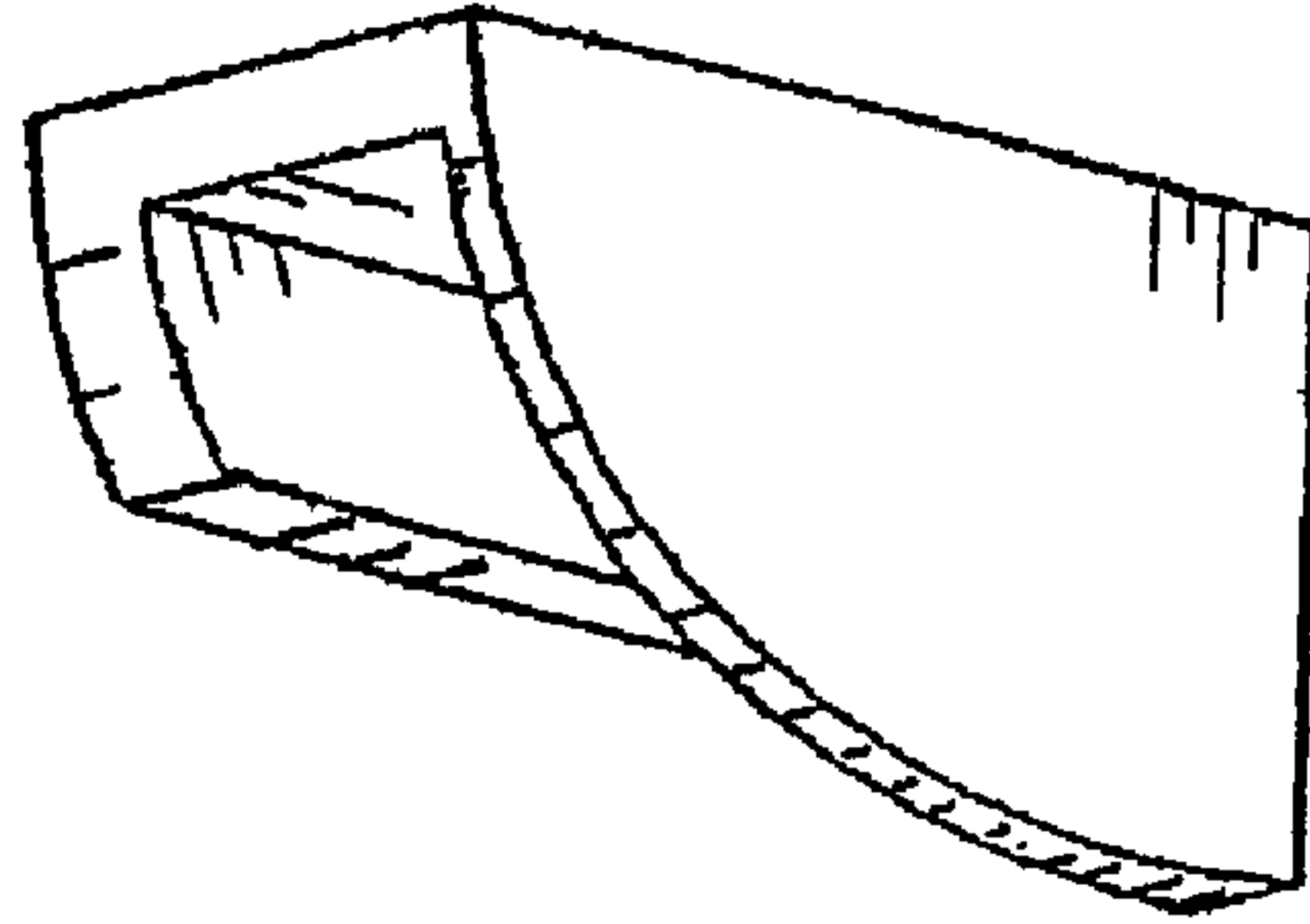

FIG. 1

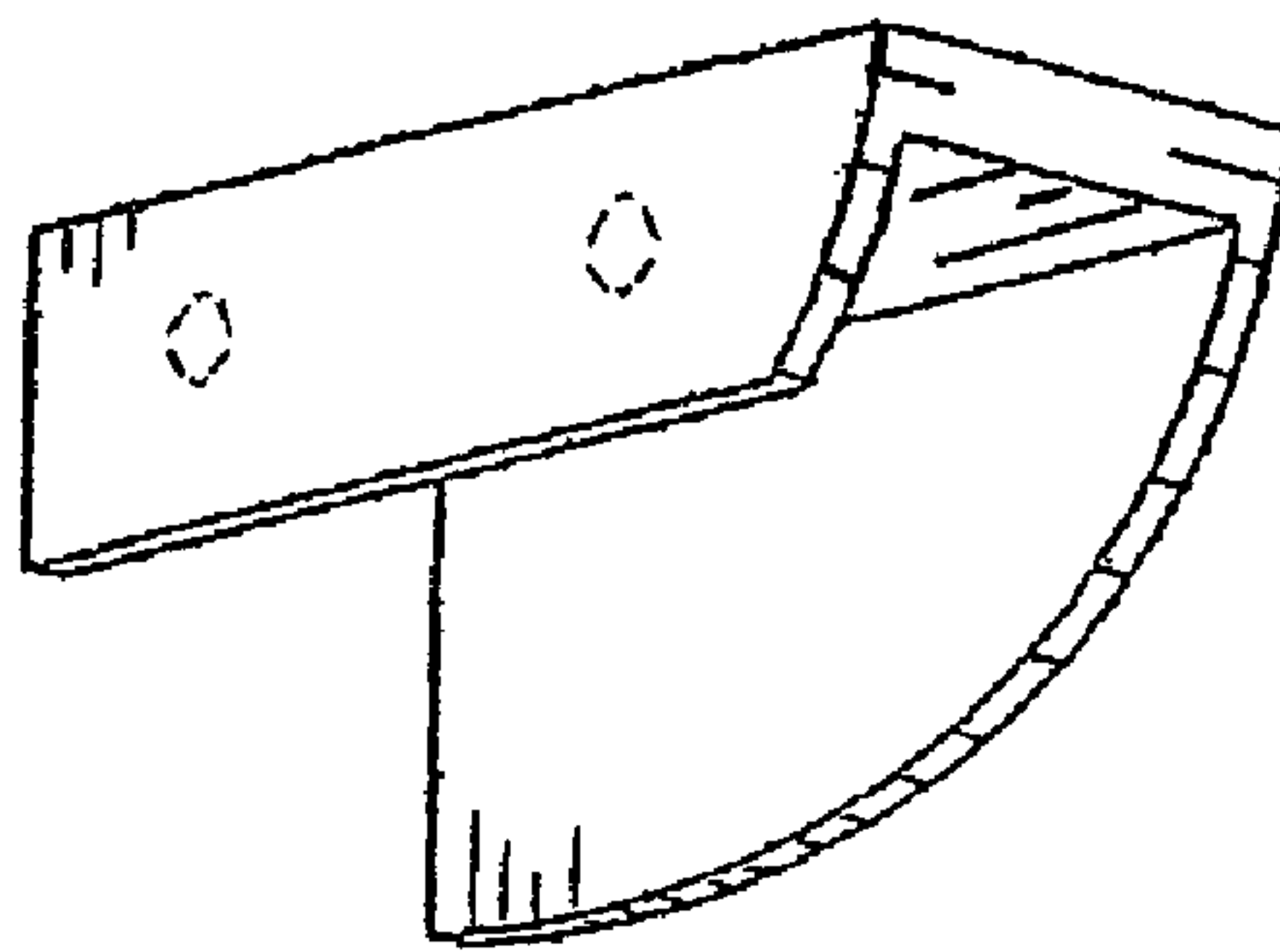

FIG. 2

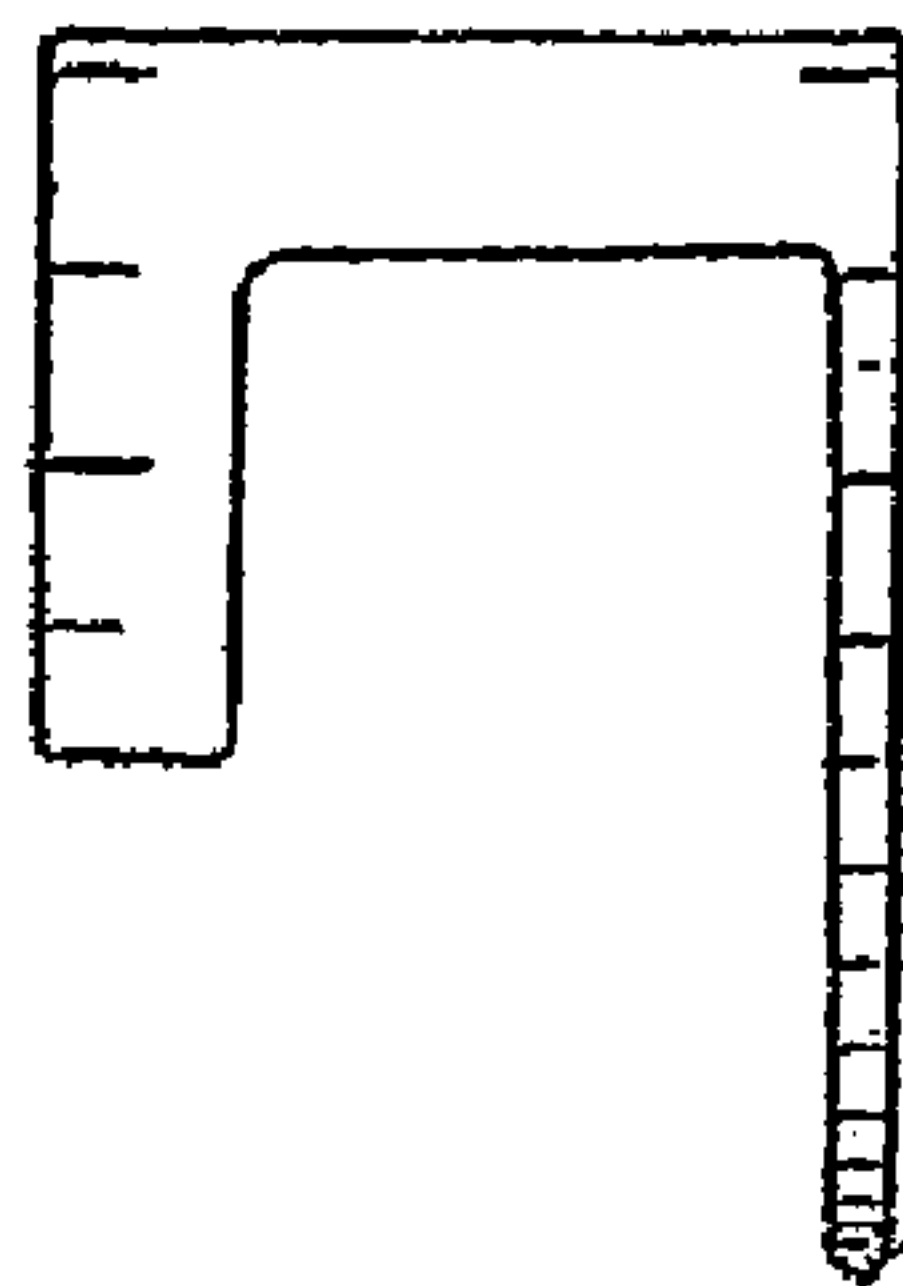

FIG. 3

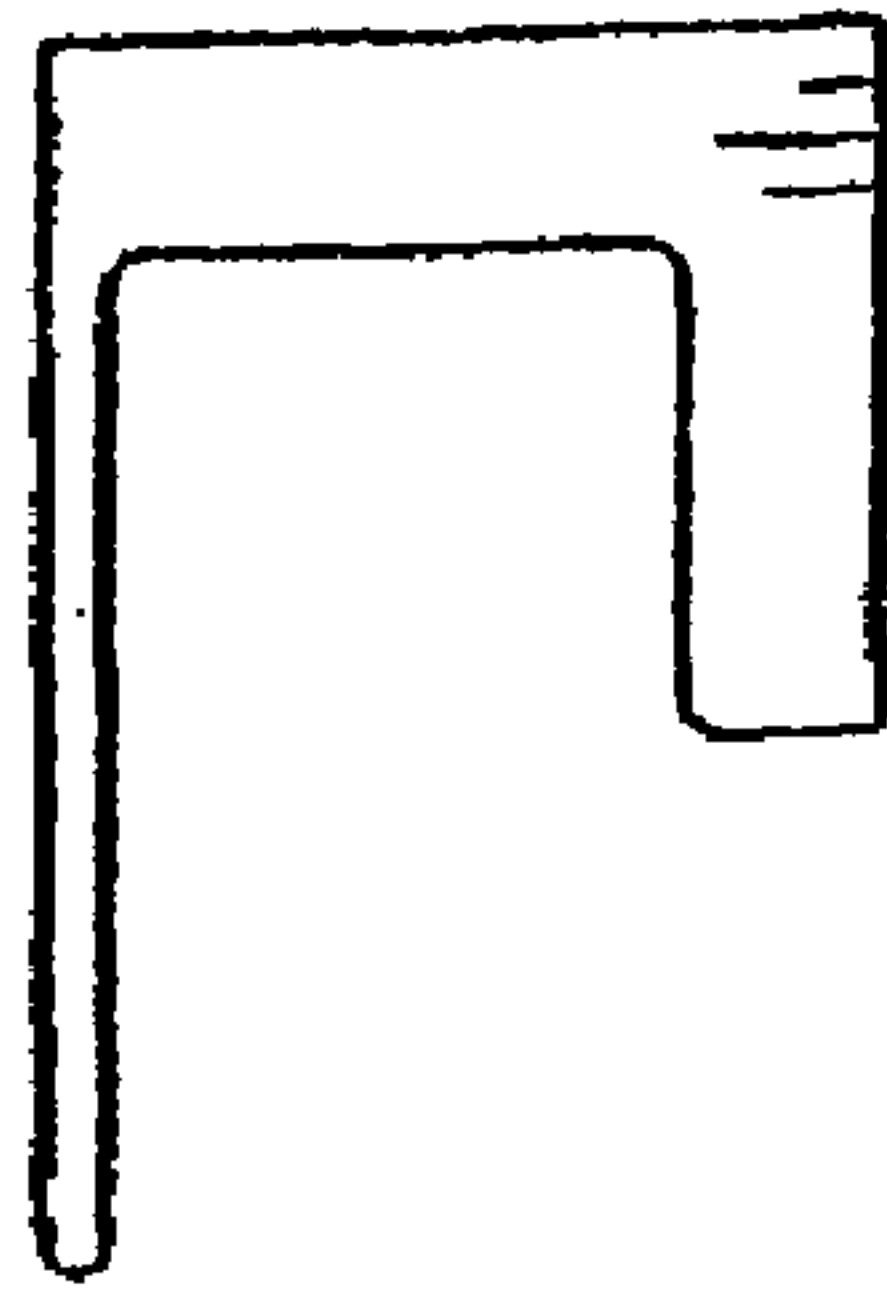

FIG. 4

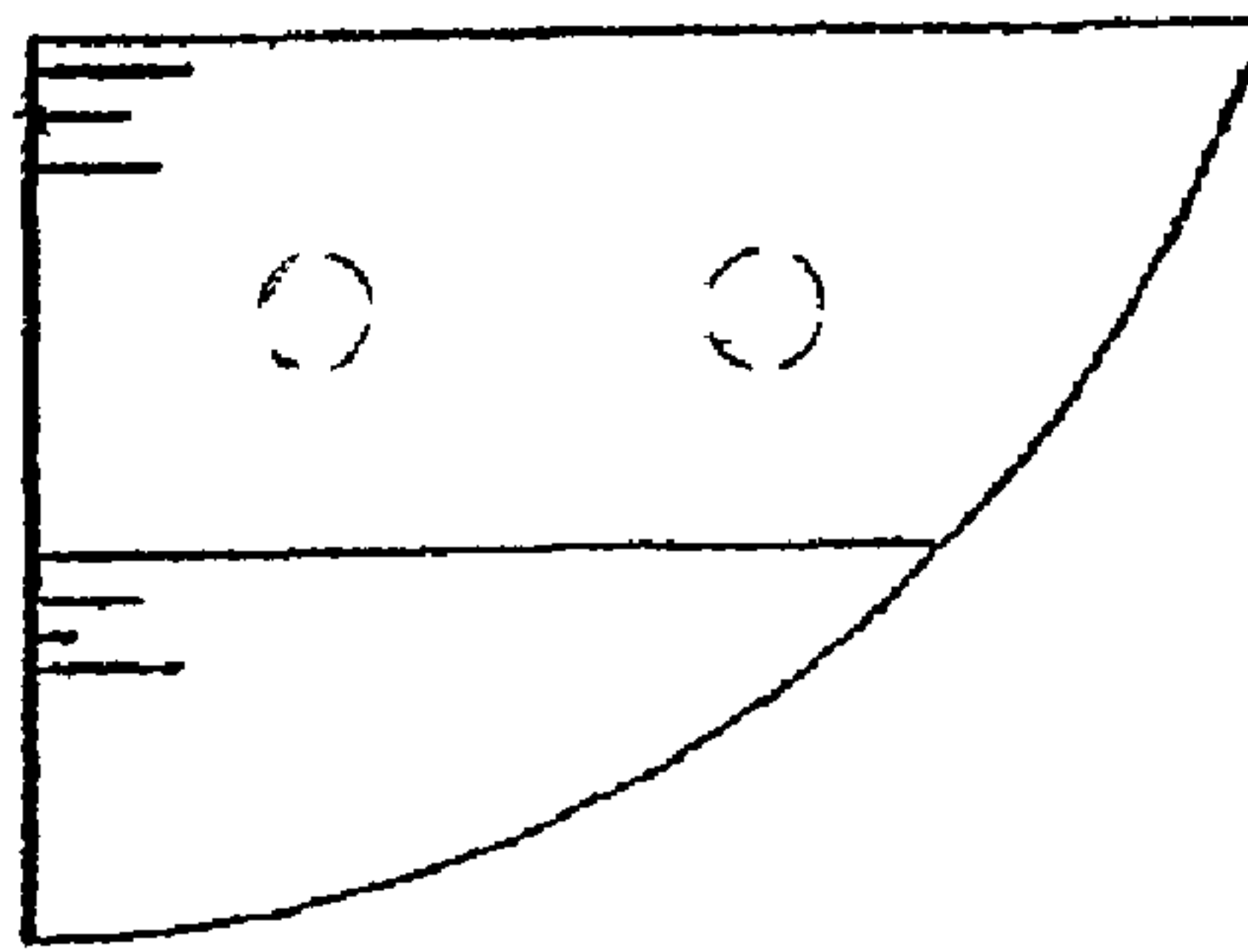

FIG. 5

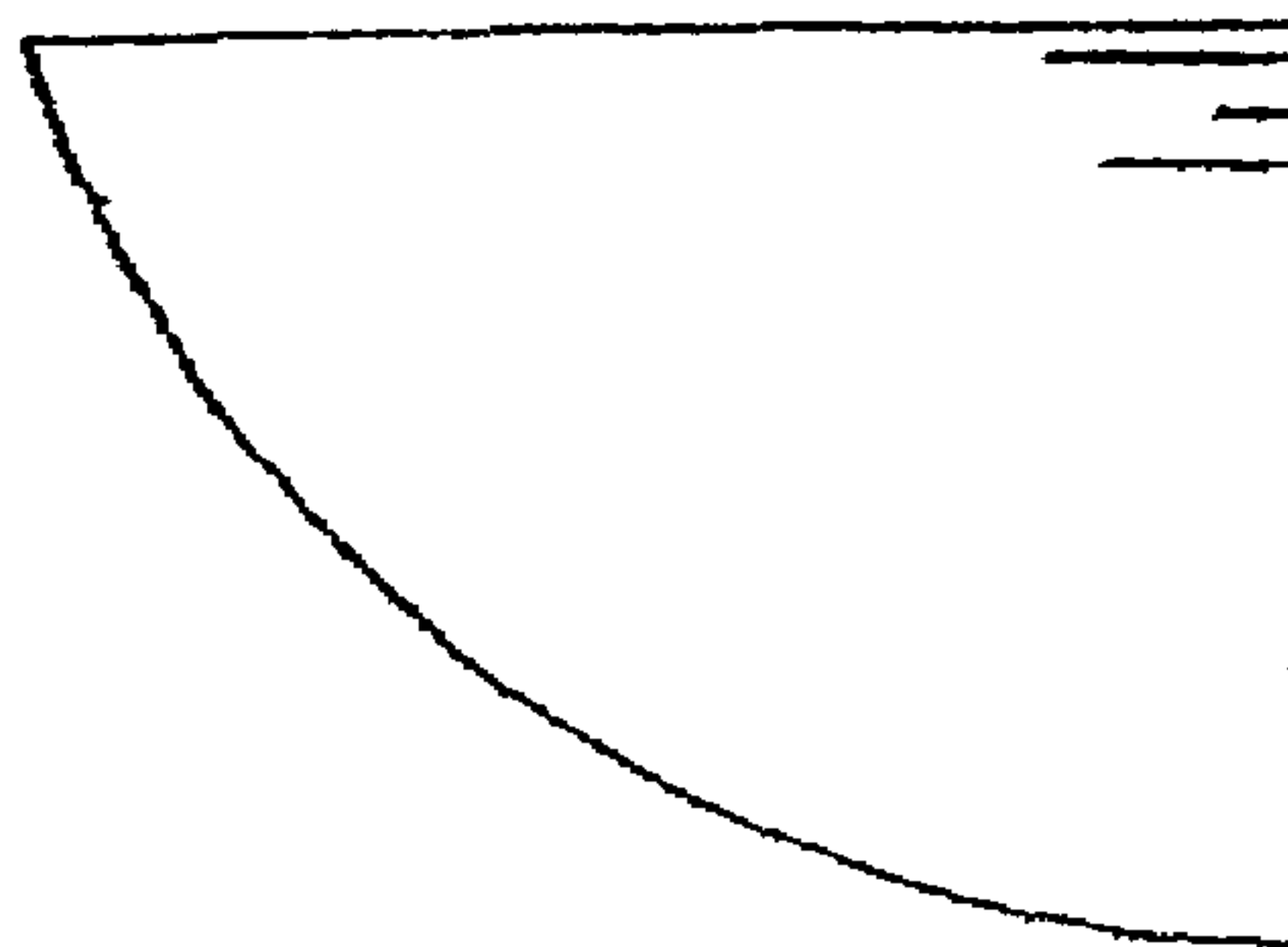

FIG. 6

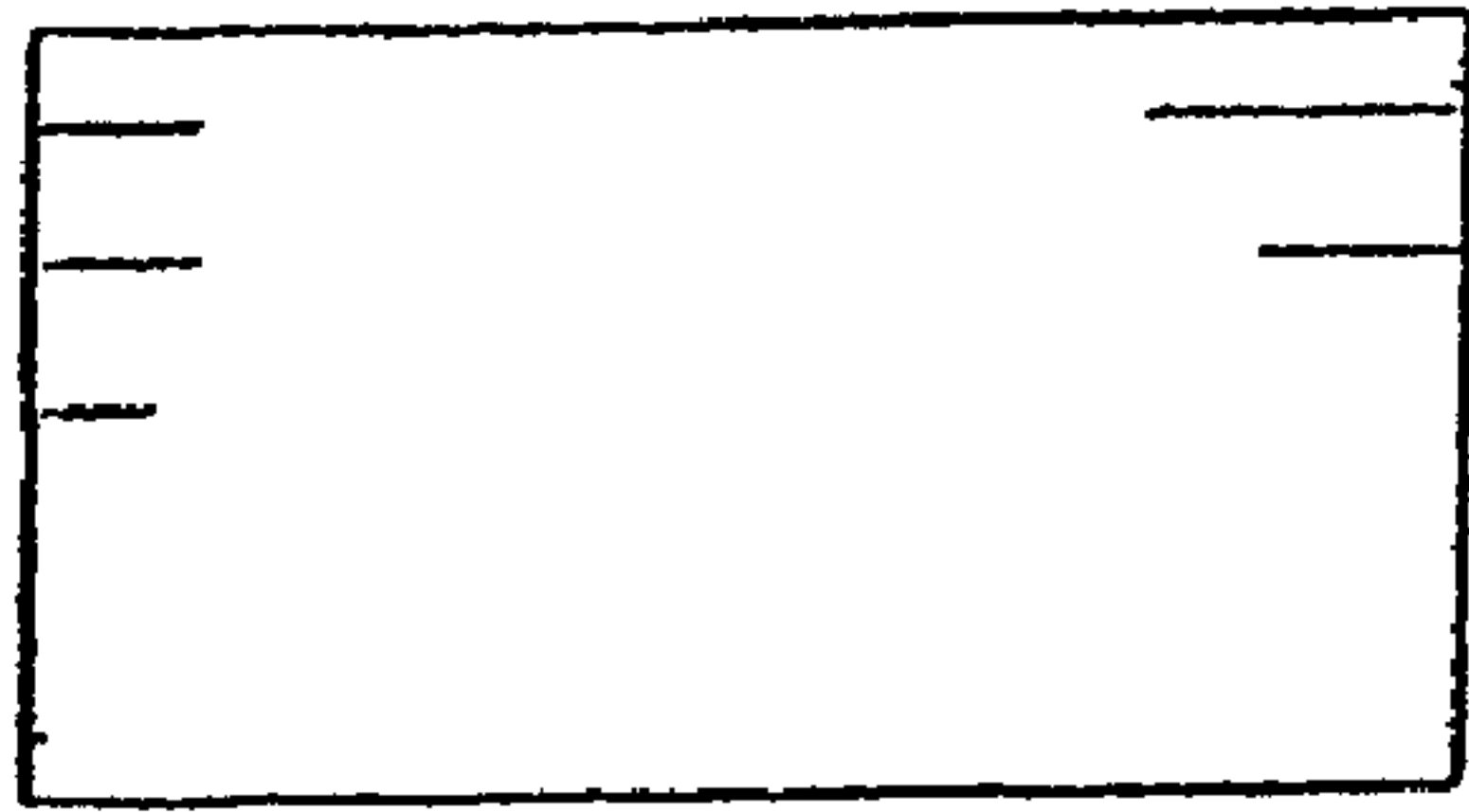

FIG. 7

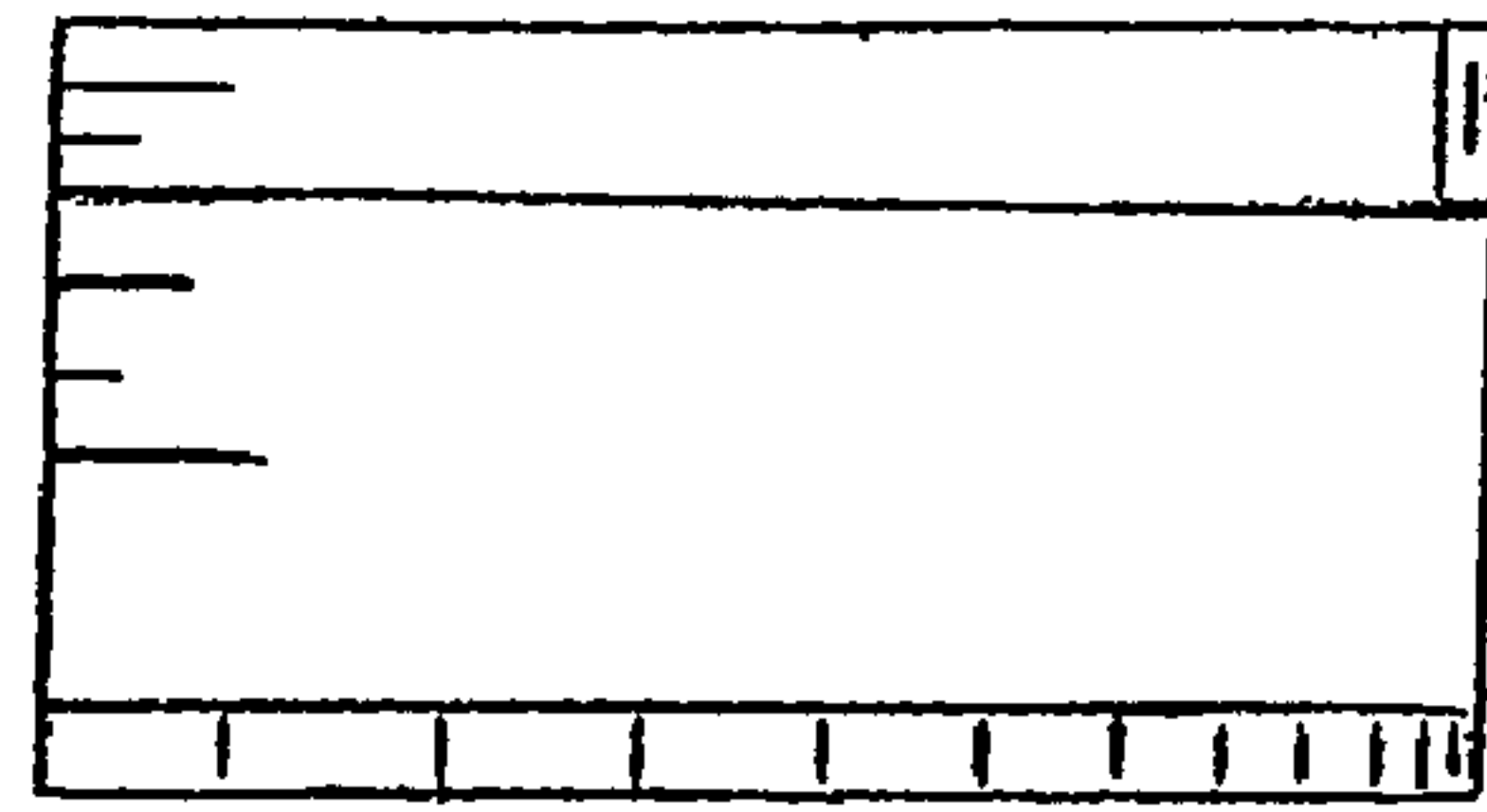

FIG. 8

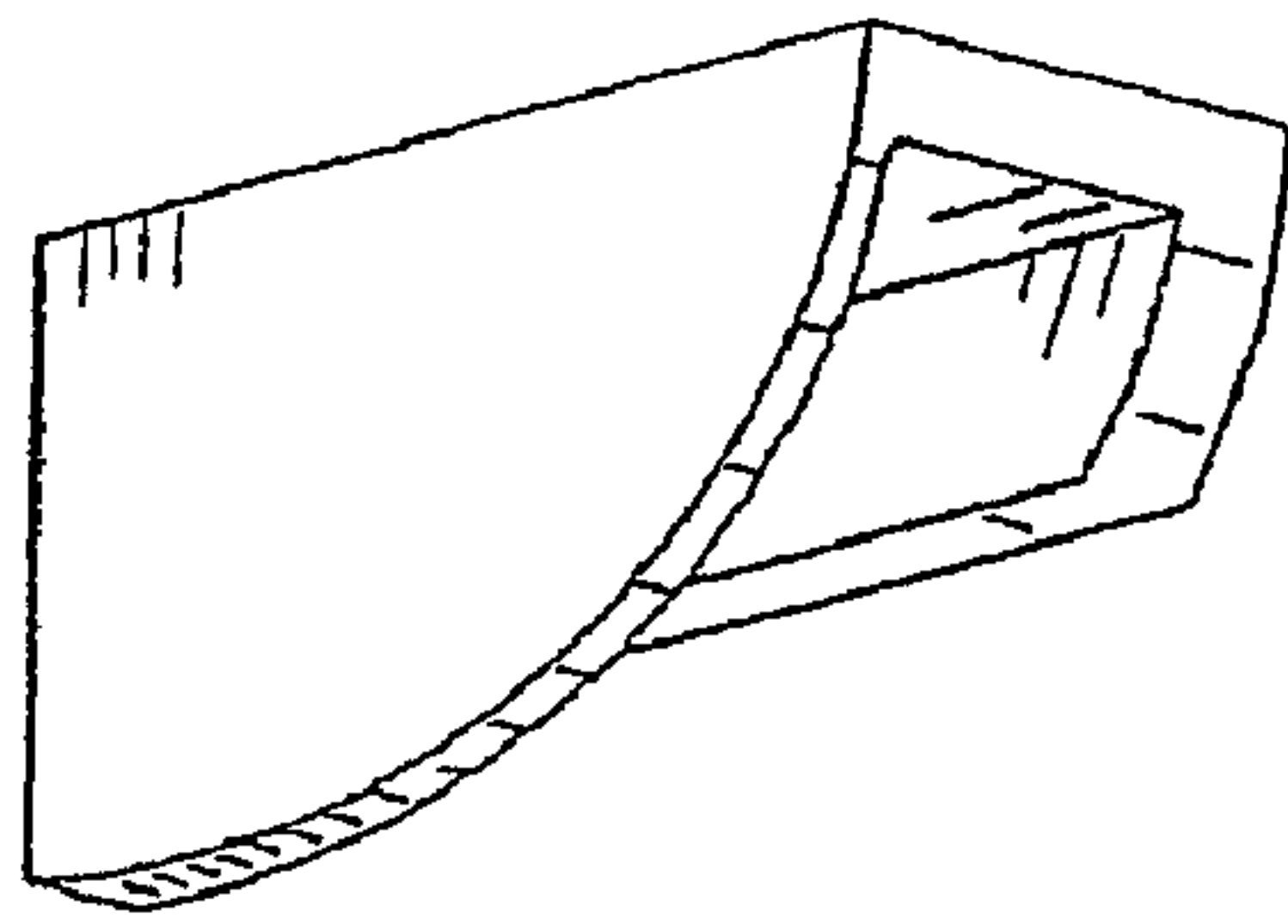

FIG. 9

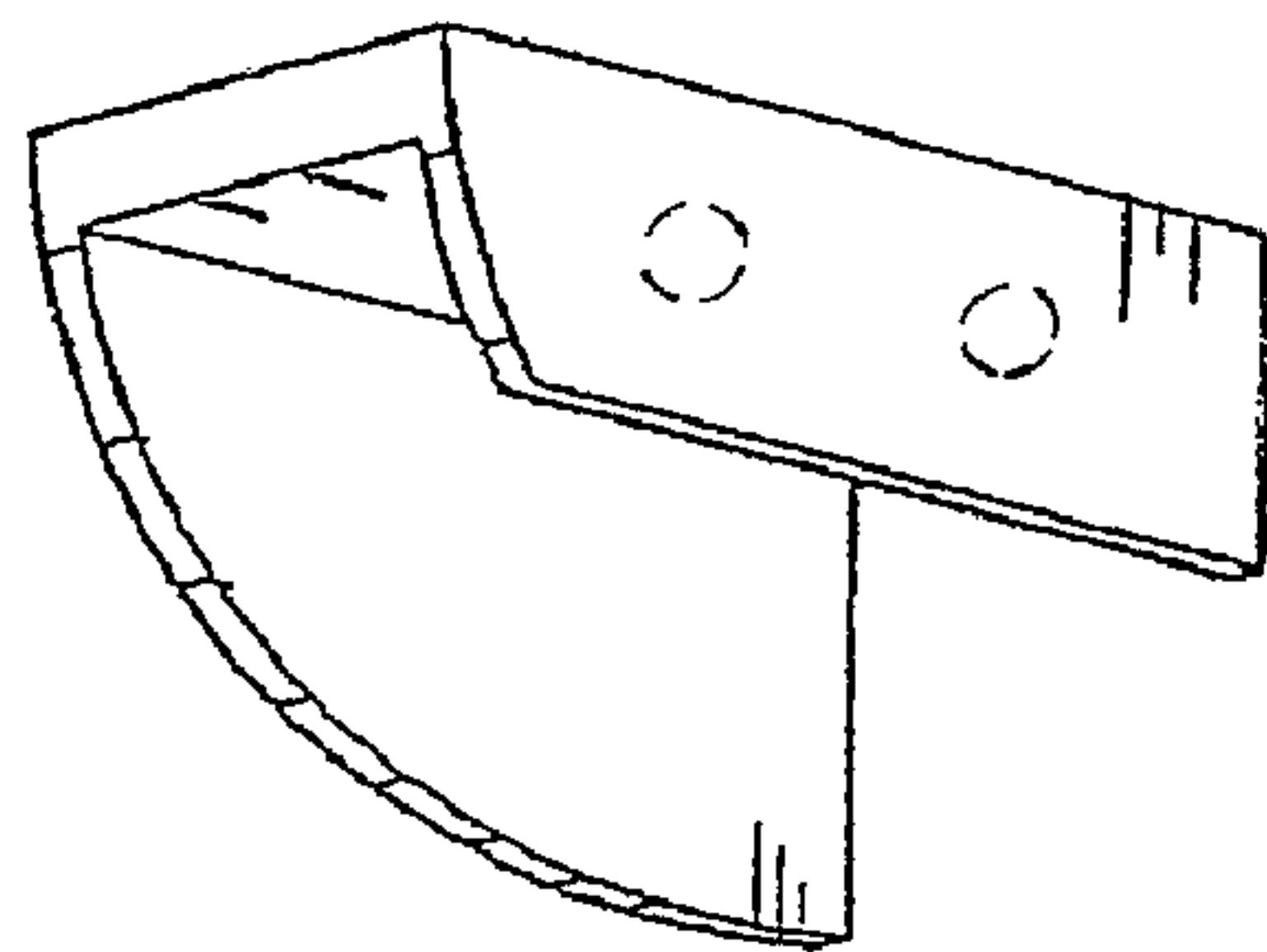

FIG. 10

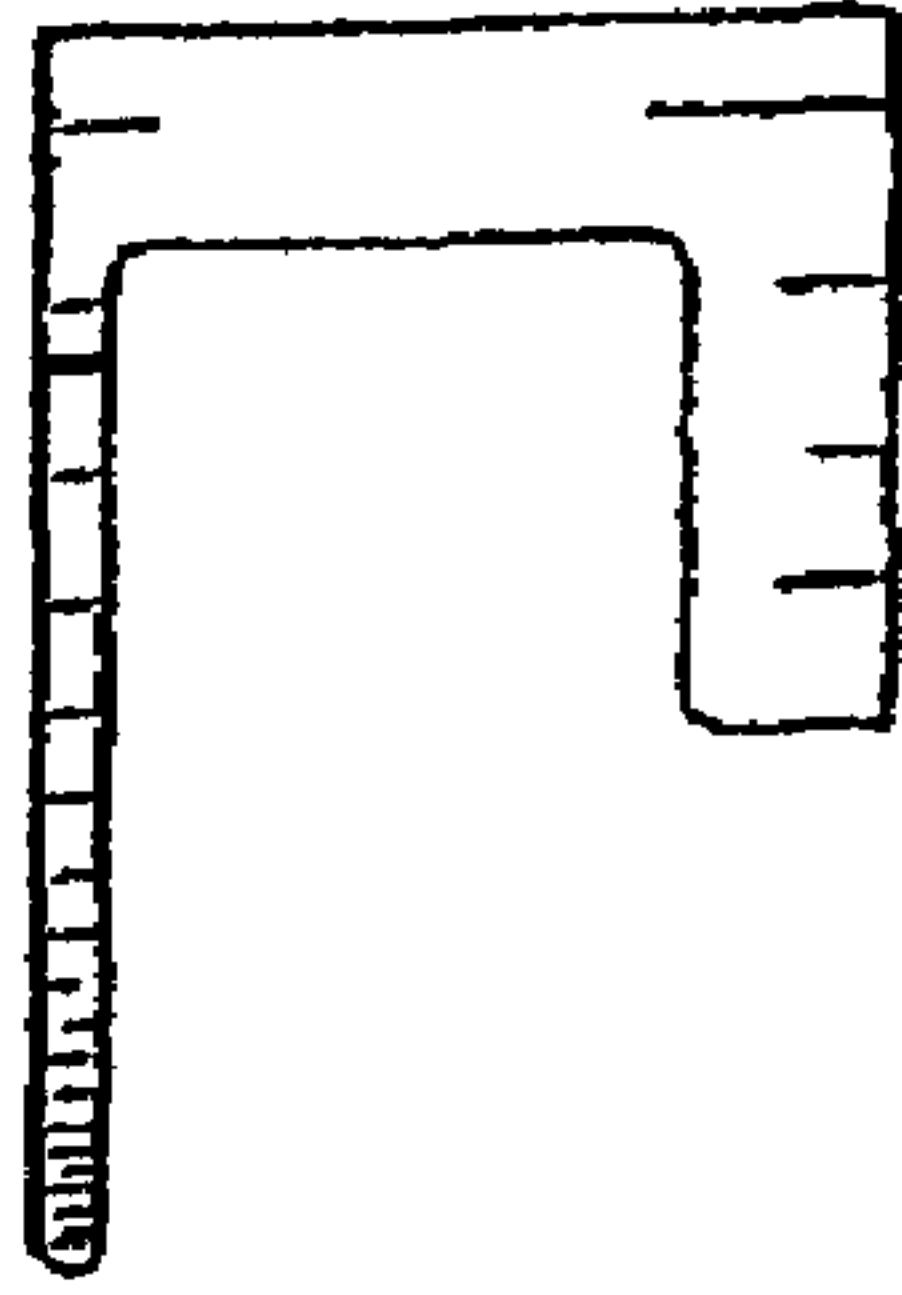

FIG. 11

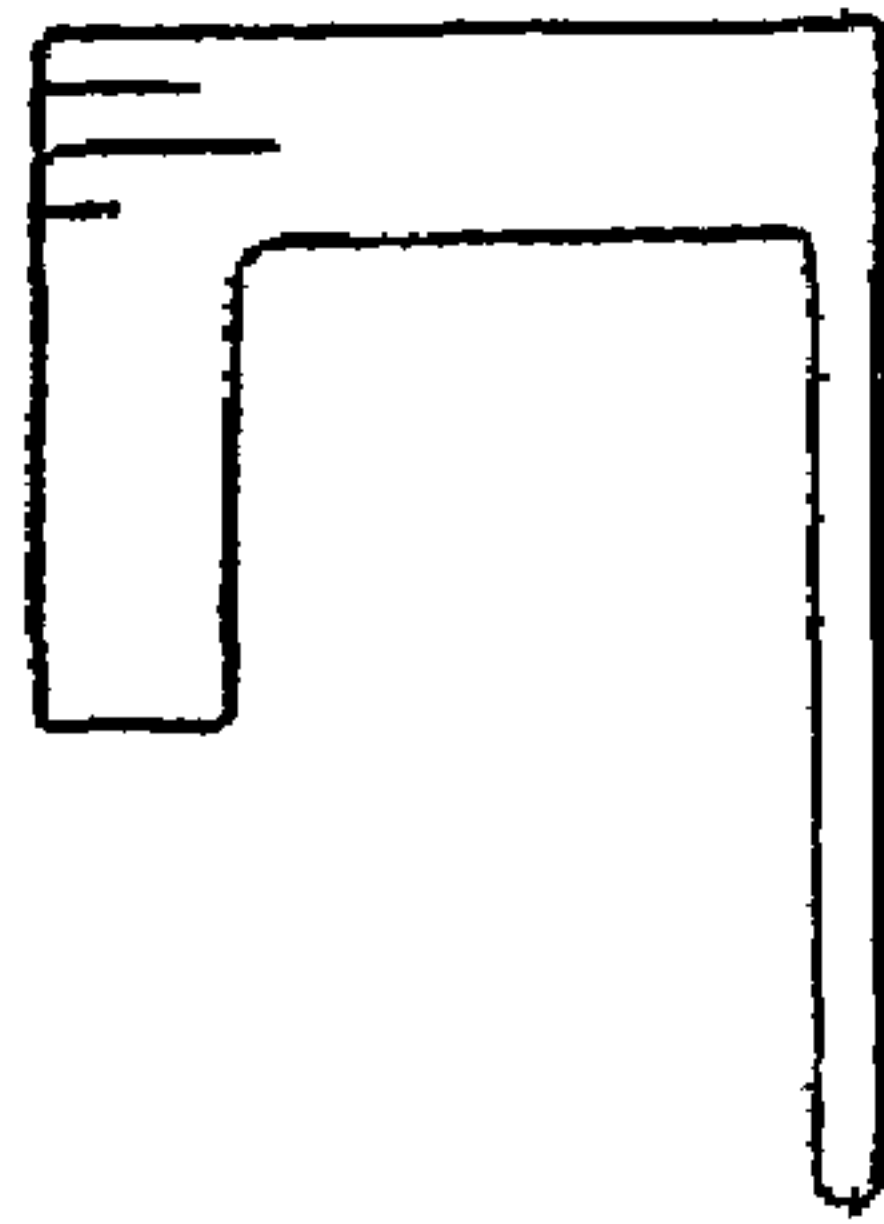

FIG. 12

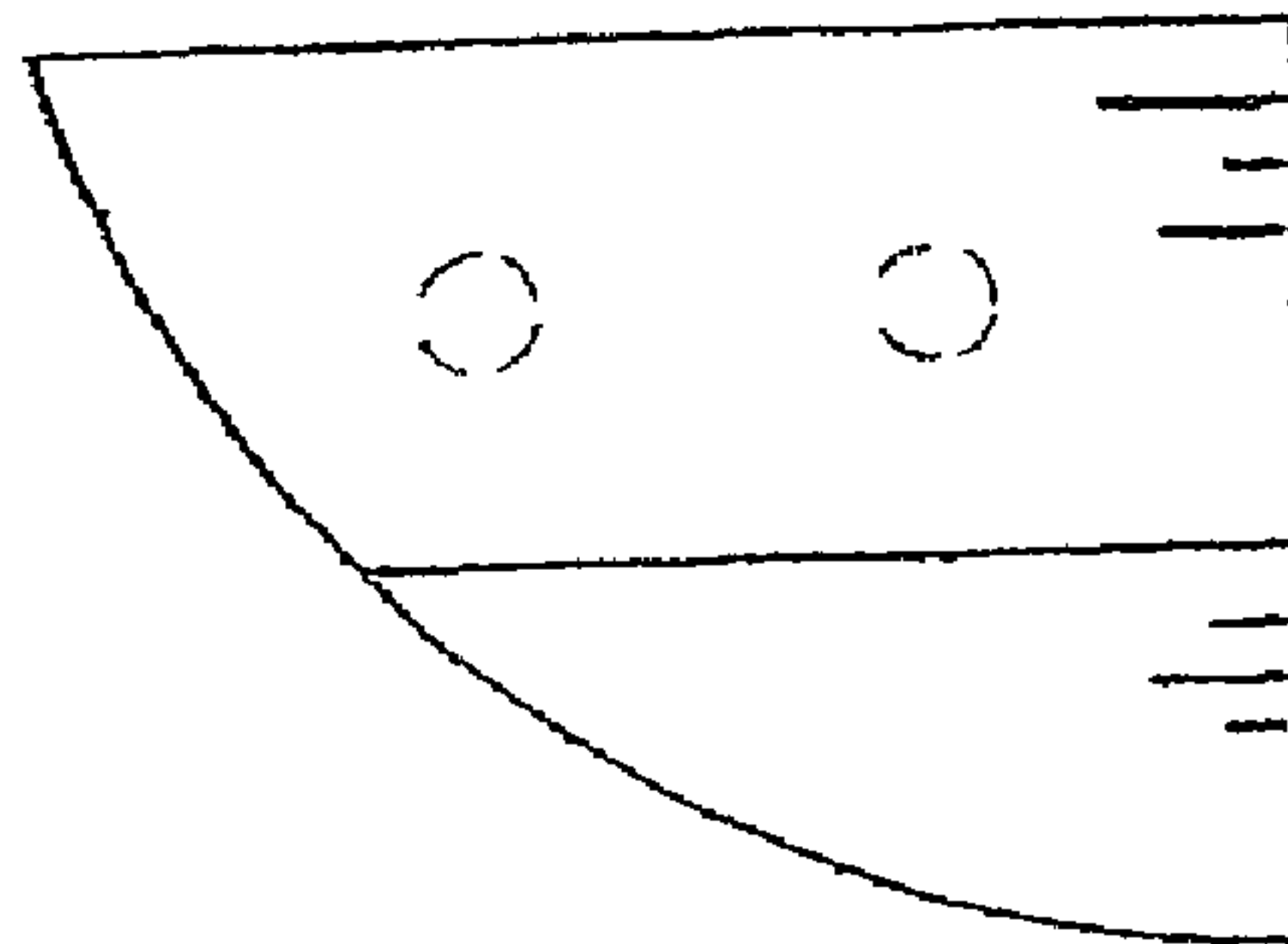

FIG. 13

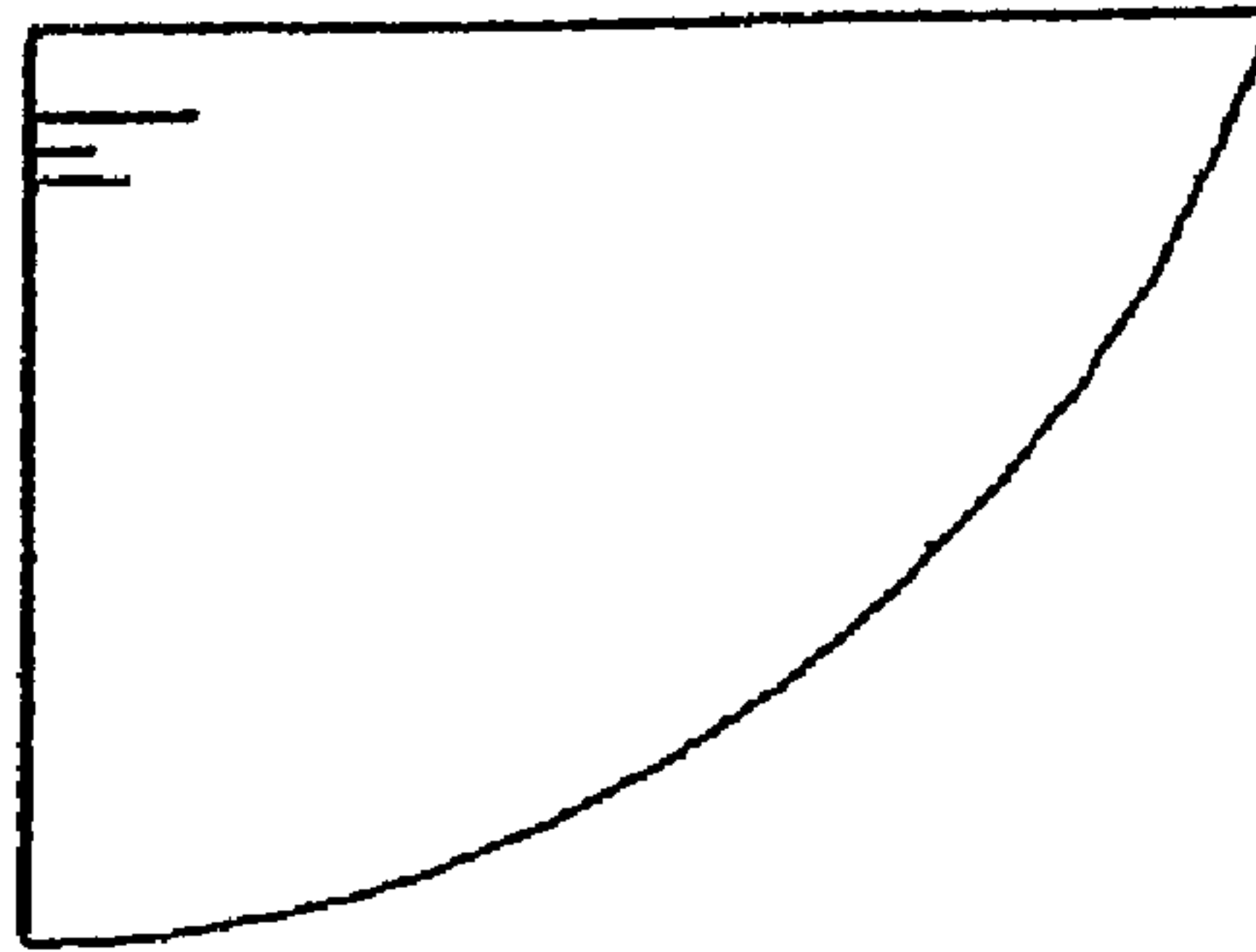

FIG. 14

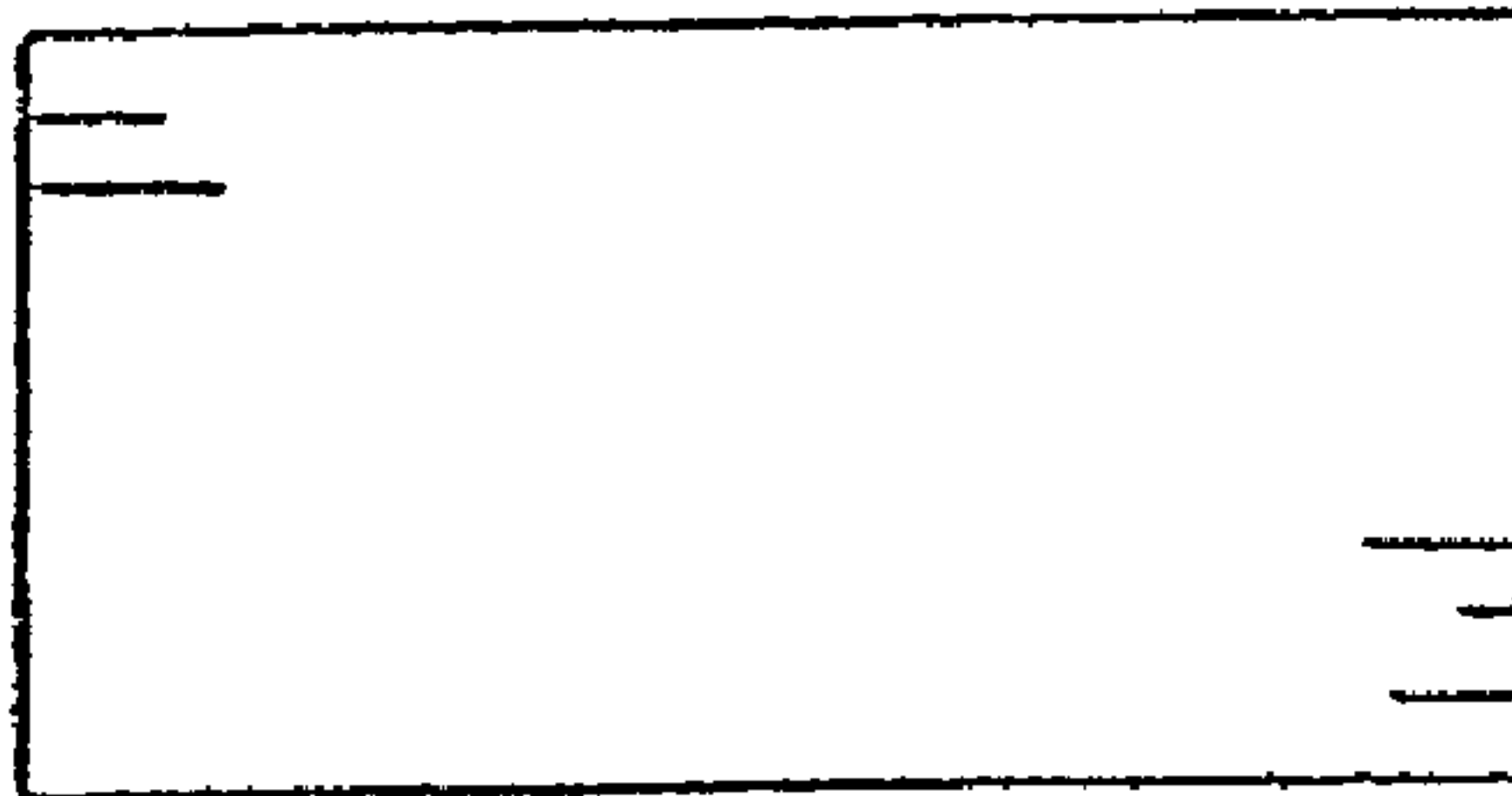

FIG. 15

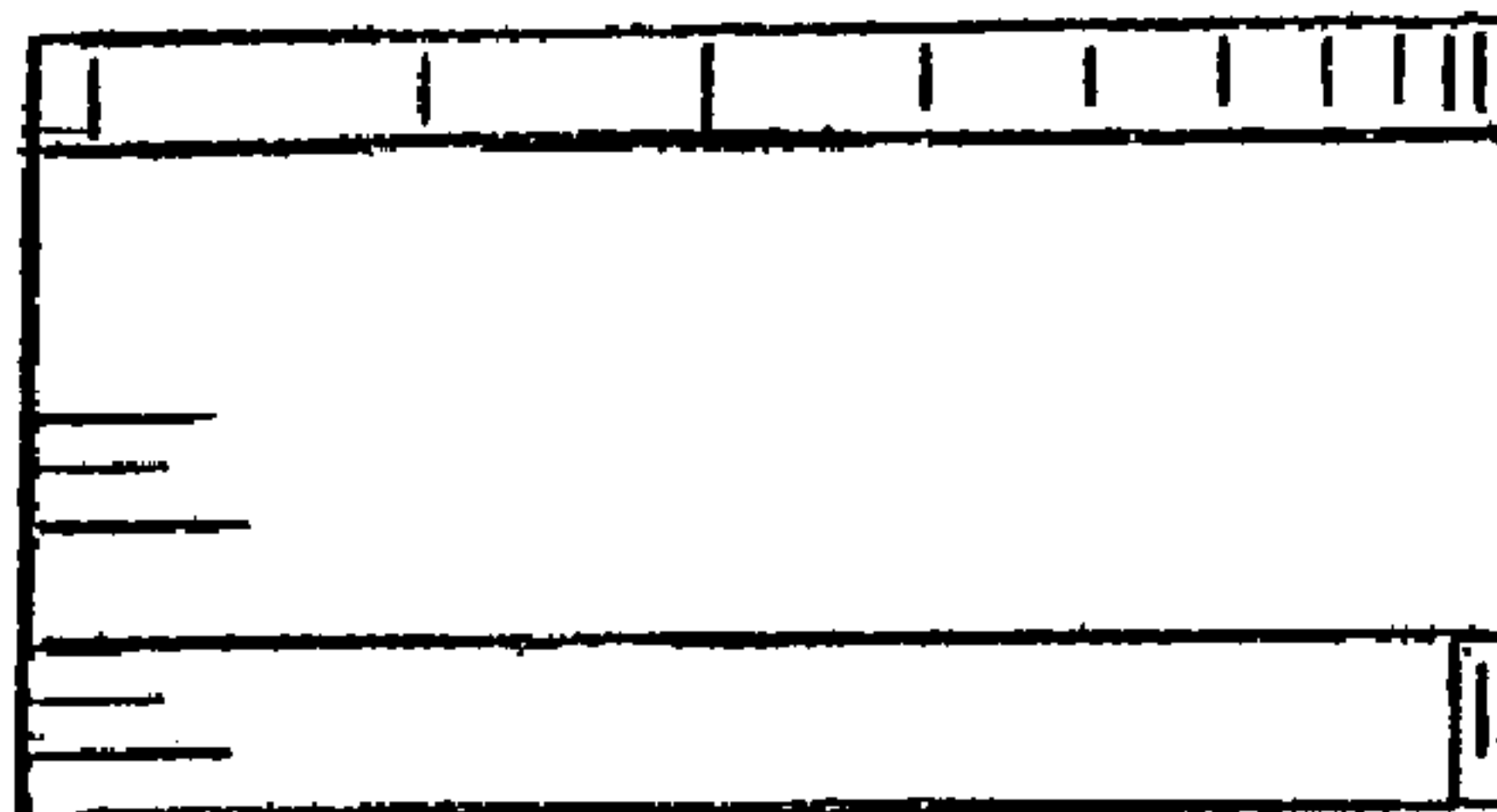

FIG. 16