



US00D575098S

(12) **United States Design Patent**
Seymour

(10) **Patent No.:** **US D575,098 S**

(45) **Date of Patent:** **** Aug. 19, 2008**

(54) **LOW PROFILE GRIDDLE**

D431,152 S * 9/2000 Lee D7/362
D436,796 S * 1/2001 Kalina et al. D7/363
D505,044 S * 5/2005 Hei D7/363

(75) Inventor: **Justun Seymour**, Eau Claire, WI (US)

(73) Assignee: **National Presto Industries, Inc.**, Eau Claire, WI (US)

* cited by examiner

Primary Examiner—Ruth McInroy

(**) Term: **14 Years**

(74) *Attorney, Agent, or Firm*—Patterson, Thuente, Skaar & Christensen, P.A.

(21) Appl. No.: **29/282,791**

(57) **CLAIM**

(22) Filed: **Jul. 30, 2007**

I claim the ornamental design for a low profile griddle, as shown.

(51) **LOC (8) Cl.** **07-02**

(52) **U.S. Cl.** **D7/363**

(58) **Field of Classification Search** D7/362–367,
D7/338, 402, 407; 219/450.1, 520, 468.1,
219/533, 386, 429, 443.1, 452.11; 99/422,
99/425, 443 R, 445, 448, 450

See application file for complete search history.

DESCRIPTION

FIG. 1 is a perspective view of a low profile griddle showing my new design;

FIG. 2 is a bottom plan view thereof;

FIG. 3 is a side elevational view thereof;

FIG. 4 is an end elevational view thereof; and,

FIG. 5 is a top plan view thereof.

(56) **References Cited**

U.S. PATENT DOCUMENTS

D296,509 S * 7/1988 Fuke D7/363
D366,390 S * 1/1996 Vitantonio D7/363

1 Claim, 5 Drawing Sheets

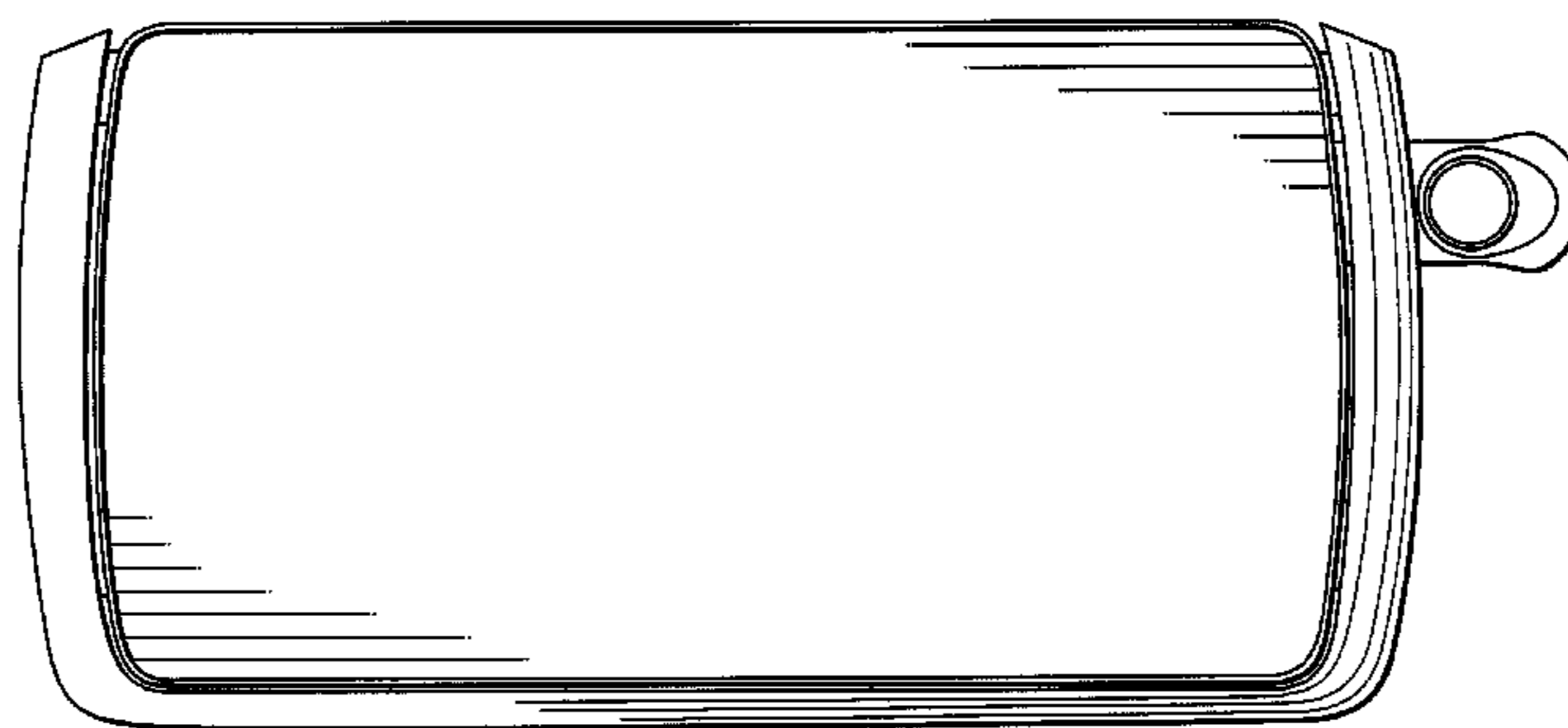
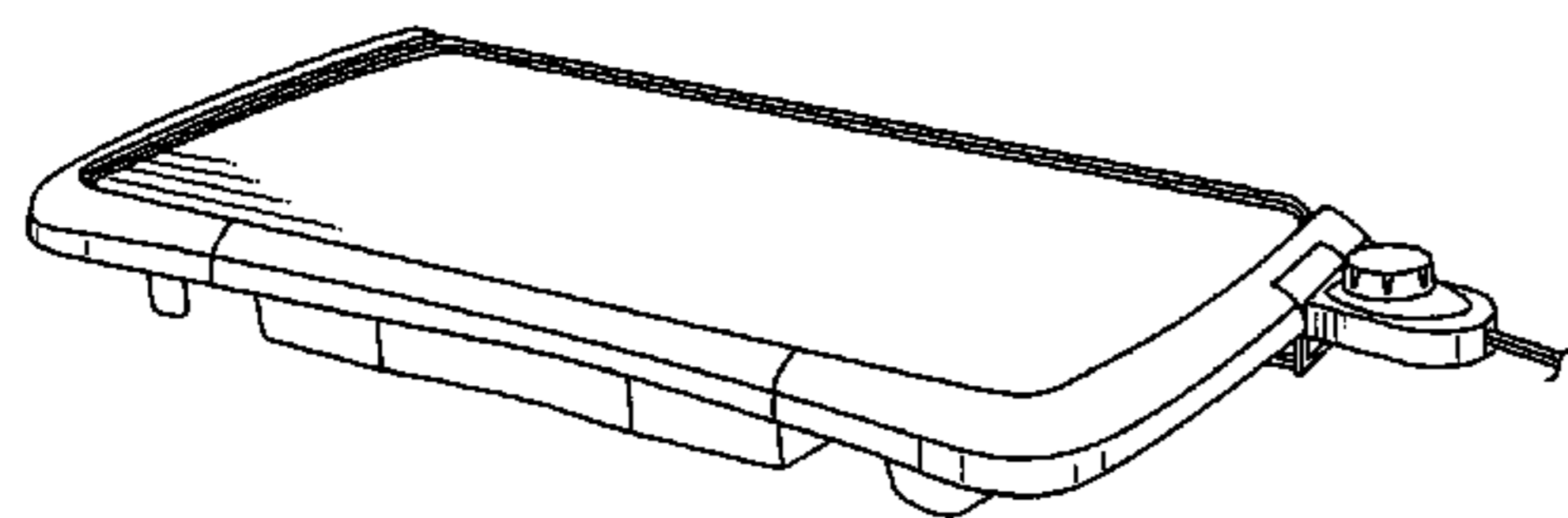

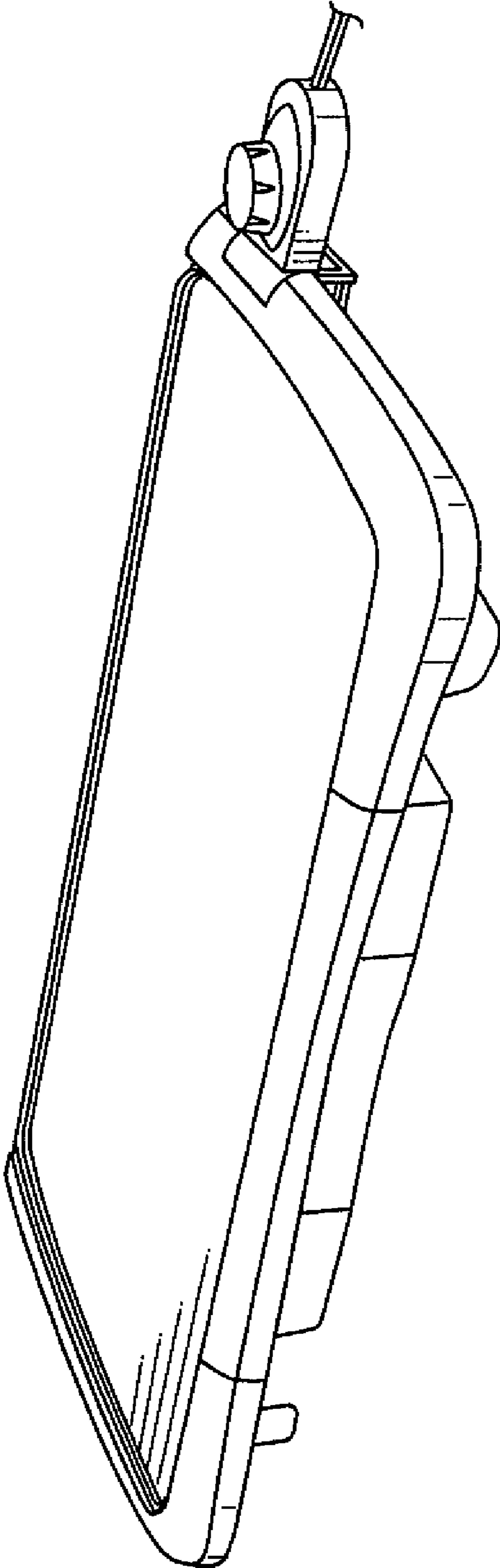

Fig. 1

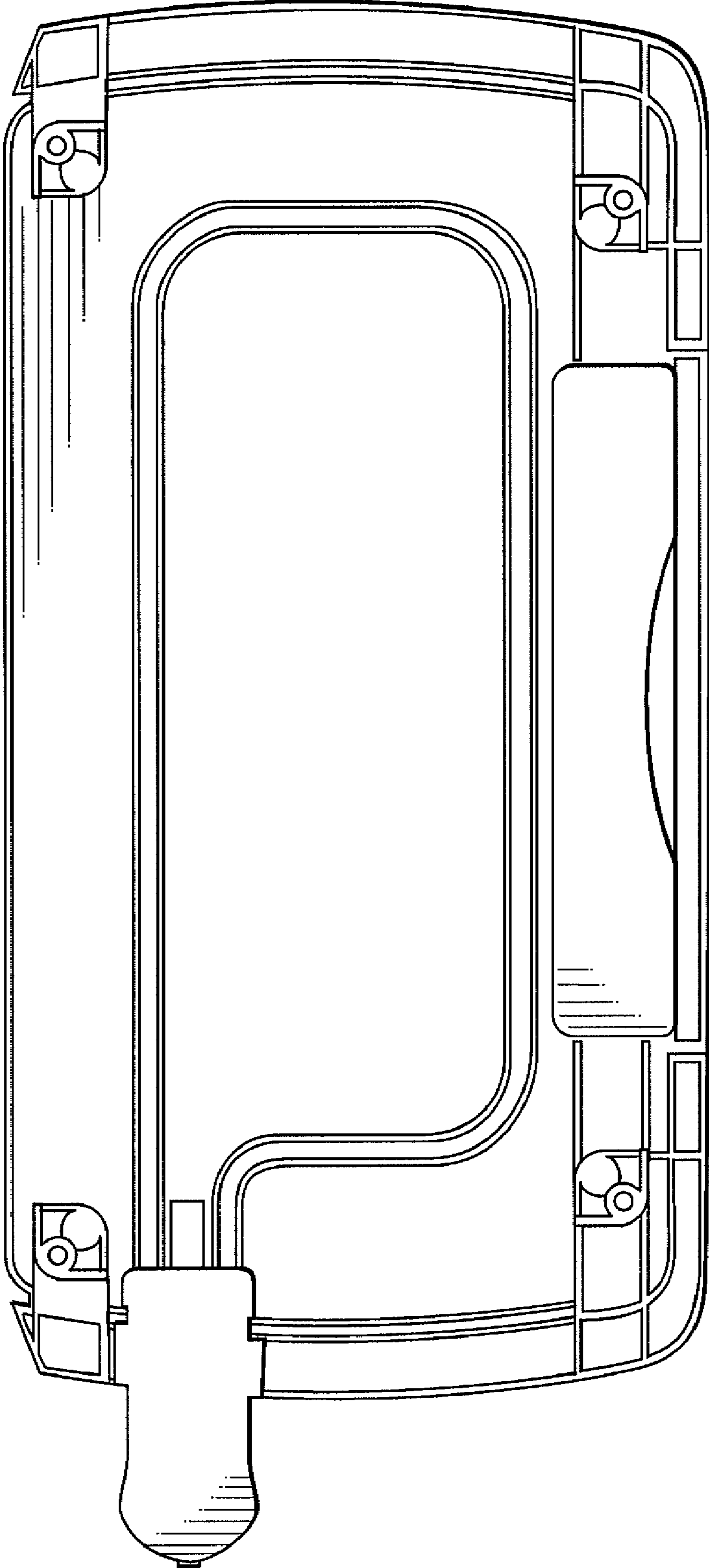

Fig. 2

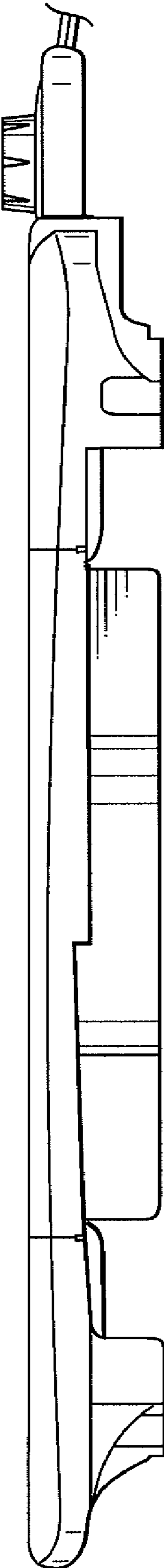

Fig. 3

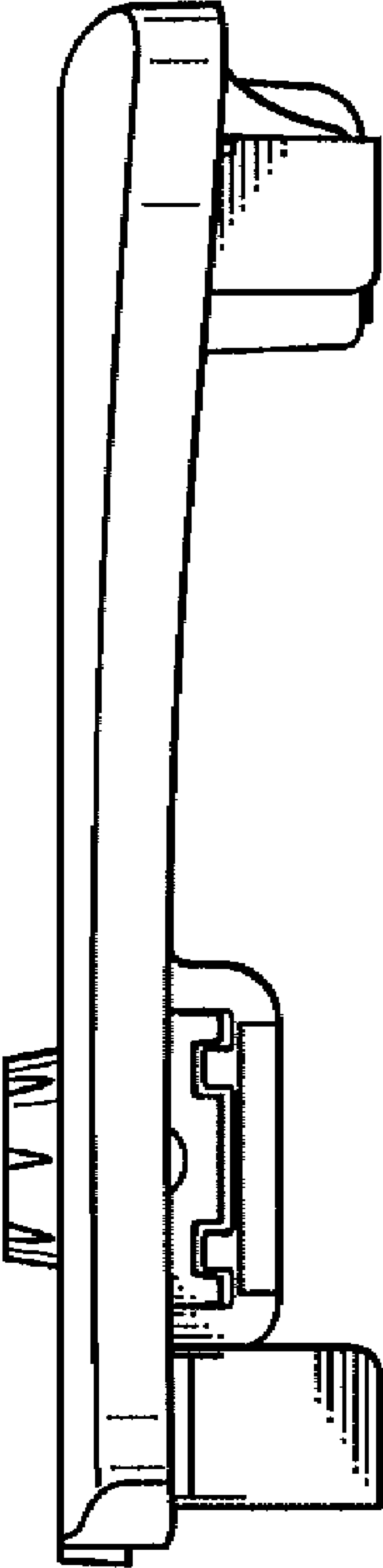

Fig. 4

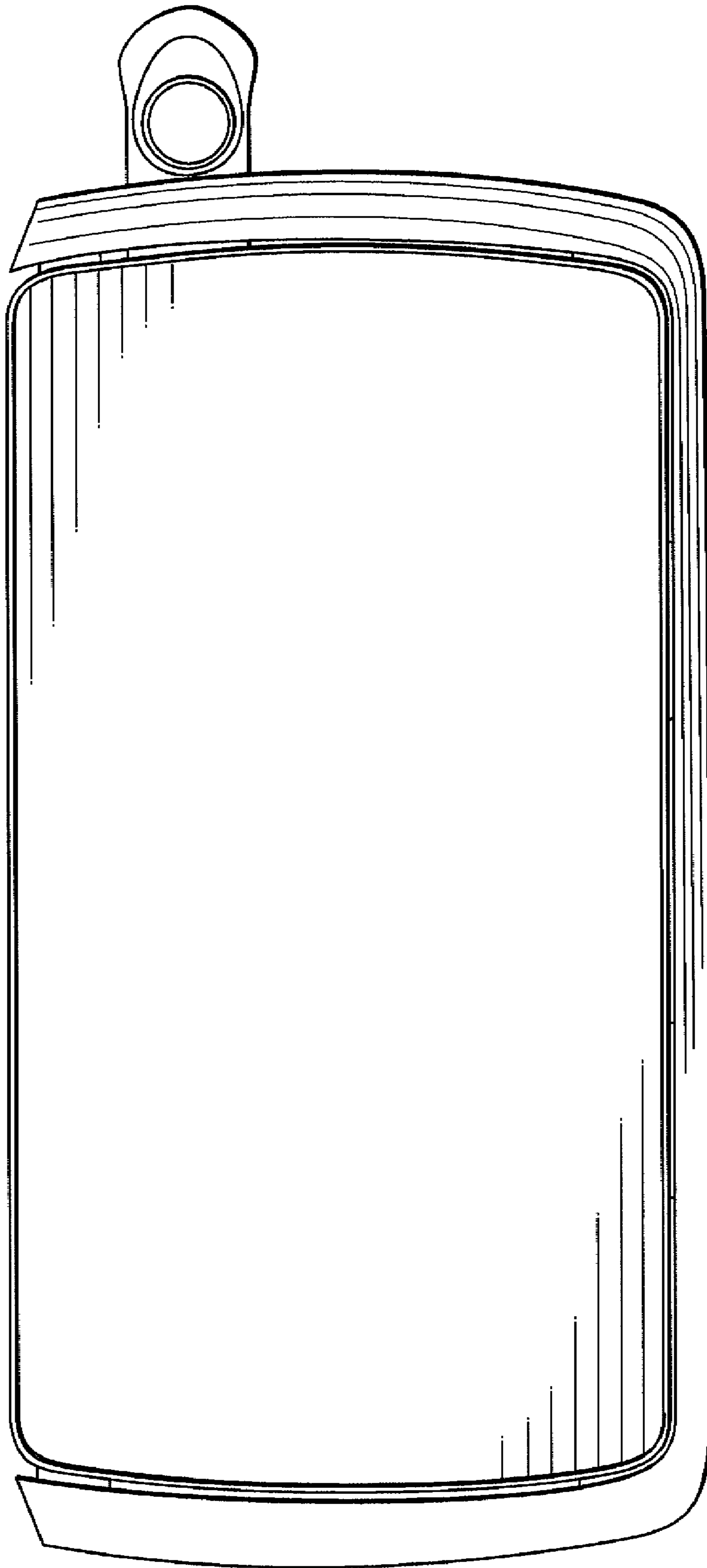

Fig. 5