



US00D575073S

(12) **United States Design Patent**  
**Mitjans**

(10) **Patent No.:** **US D575,073 S**  
(45) **Date of Patent:** **\*\* Aug. 19, 2008**

(54) **BLOCK OF SEATS**

(75) Inventor: **Jose Figueras Mitjans**, Llica d' Amunt (ES)

(73) Assignee: **Figueras International Seating, S.A.**, Barcelona (ES)

(\*\*) Term: **14 Years**

(21) Appl. No.: **29/222,696**

(22) Filed: **Feb. 3, 2005**

(30) **Foreign Application Priority Data**

Aug. 6, 2004 (EM) ..... 000213004

(51) **LOC (8) Cl.** ..... **06-01**

(52) **U.S. Cl.** ..... **D6/381**

(58) **Field of Classification Search** ..... D6/334-338, D6/349, 355, 363, 364, 369-370, 381, 491, D6/500-502, 509, 511, 601; 297/16.1-16.2, 297/116, 135, 154, 187, 158.3, 158.4, 158.5, 297/184.1, 232, 244, 411.37, 440.1, 445.1; 5/12.1, 655.3

See application file for complete search history.

(56) **References Cited**

U.S. PATENT DOCUMENTS

D187,919 S \* 5/1960 Barecki ..... D6/375

(Continued)

*Primary Examiner*—Sandra Snapp

(74) *Attorney, Agent, or Firm*—Lucas & Mercanti, LLP

(57) **CLAIM**

The ornamental design for a block of seats, as shown and described.

**DESCRIPTION**

FIG. 1 is a perspective view of a block of seats in accordance with one embodiment of our design;

FIG. 2 is a rear perspective view thereof;

FIG. 3 is a right side elevation view thereof, the left side elevation view being a mirror image thereof;

FIG. 4 is a rear elevation view thereof;

FIG. 5 is a bottom plan view thereof;

FIG. 6 is a front elevation view thereof;

FIG. 7 is a top plan view thereof

FIG. 8. is a perspective view of a block of seats in accordance with a second embodiment of our design;

FIG. 9 is a rear perspective view thereof;

FIG. 10 is a right side elevation view thereof, the left side elevation view being a mirror image thereof;

FIG. 11 is a rear elevation view thereof;

FIG. 12 is a bottom plan view thereof;

FIG. 13 is a front elevation view thereof;

FIG. 14 is a top plan view thereof;

FIG. 15 is a front perspective view of a block of seats in accordance with a third embodiment of our design;

FIG. 16 is a rear perspective view thereof;

FIG. 17 is a right side elevation view thereof, the left side elevation view being a mirror image thereof;

FIG. 18 is a rear elevation view thereof;

FIG. 19 is a bottom plan view thereof;

FIG. 20 is front elevation view thereof;

FIG. 21 is a top plan view thereof;

FIG. 22 is a front perspective view of a block of seats in accordance with a fourth embodiment of our design;

FIG. 23 is a rear perspective view thereof;

FIG. 24. is a right side elevation view thereof, the left side elevation view being a mirror image thereof;

FIG. 25 is a rear elevation view thereof;

FIG. 26 is a bottom plan view thereof;

FIG. 27 is front elevation view thereof; and,

FIG. 28 is a top plan view thereof.

**1 Claim, 12 Drawing Sheets**

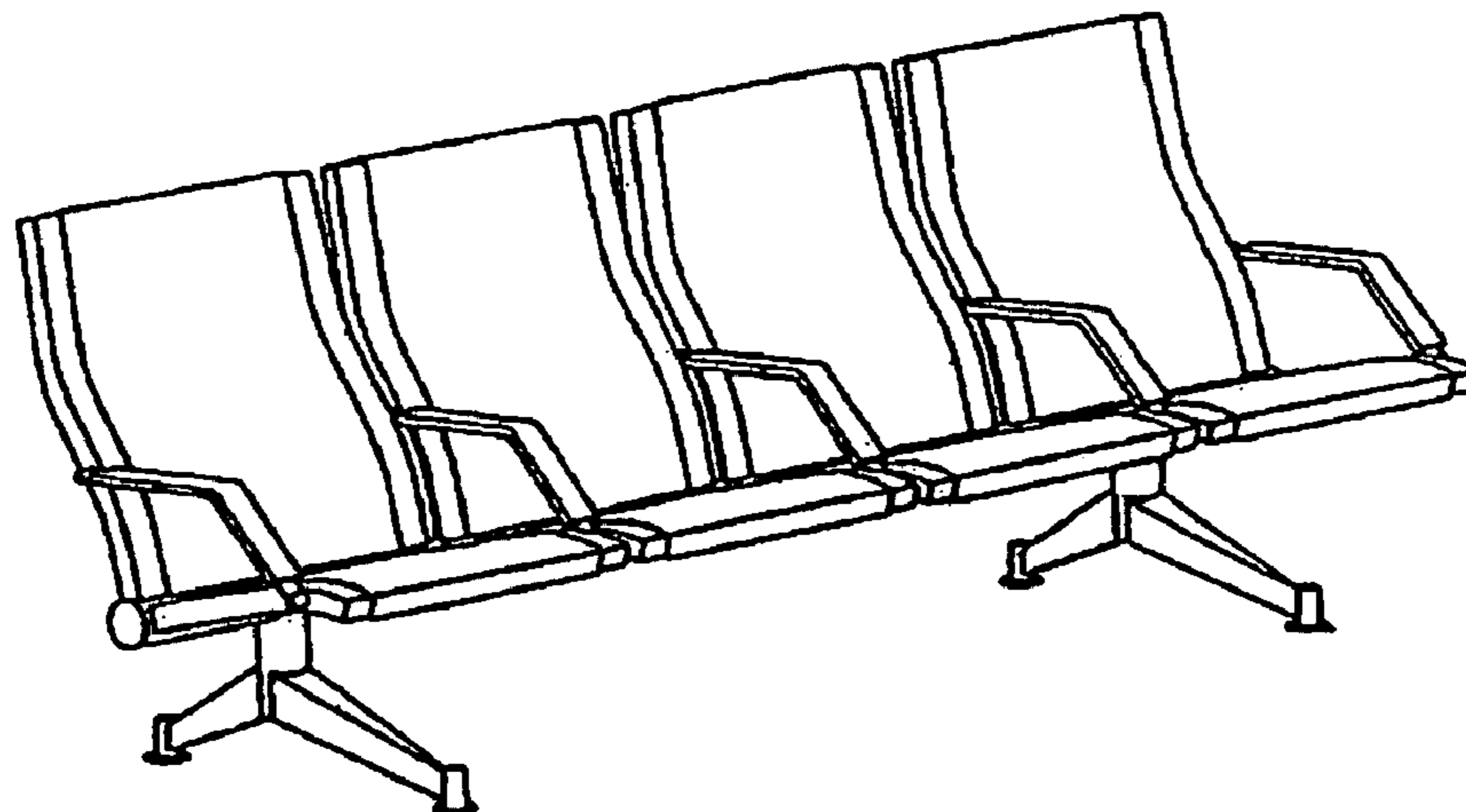

# US D575,073 S

Page 2

---

## U.S. PATENT DOCUMENTS

3,124,390	A *	3/1964	Eames et al. ....	297/452.19	D419,314	S *	1/2000	Saul .....	D6/336
3,990,741	A *	11/1976	Snyder et al. ....	297/248	6,095,603	A *	8/2000	Hock .....	297/232
D253,859	S *	1/1980	Hosoe .....	D6/372	D440,422	S *	4/2001	DeJule .....	D6/371
D343,967	S *	2/1994	Citterio .....	D6/381	D445,574	S *	7/2001	Foster .....	D6/336
D347,330	S *	5/1994	Kinsman .....	D6/334	D498,077	S *	11/2004	Tonizzo .....	D6/381
D412,622	S *	8/1999	DeJule .....	D6/371	D537,648	S *	3/2007	Moschini .....	D6/381

\* cited by examiner

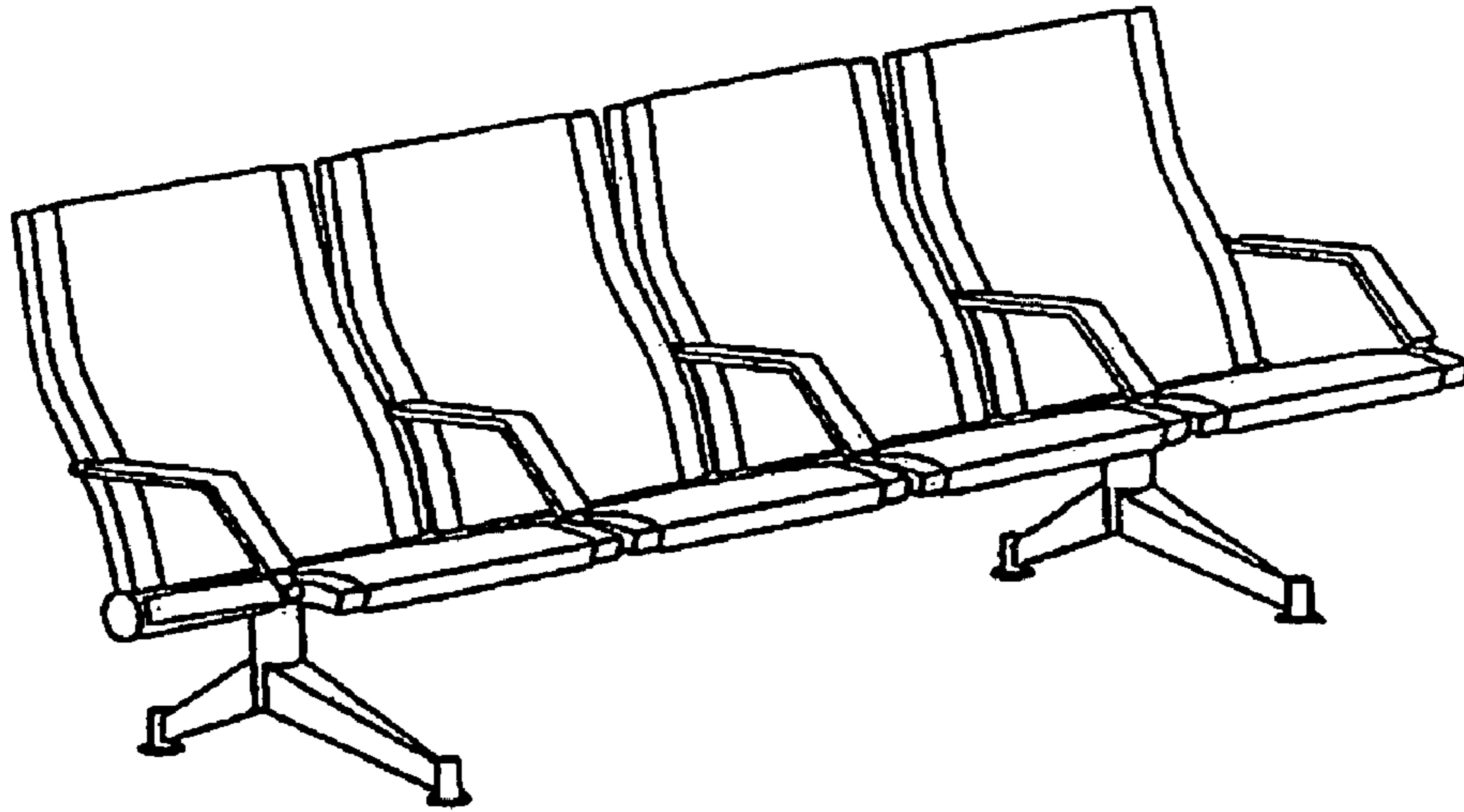

FIG. 1

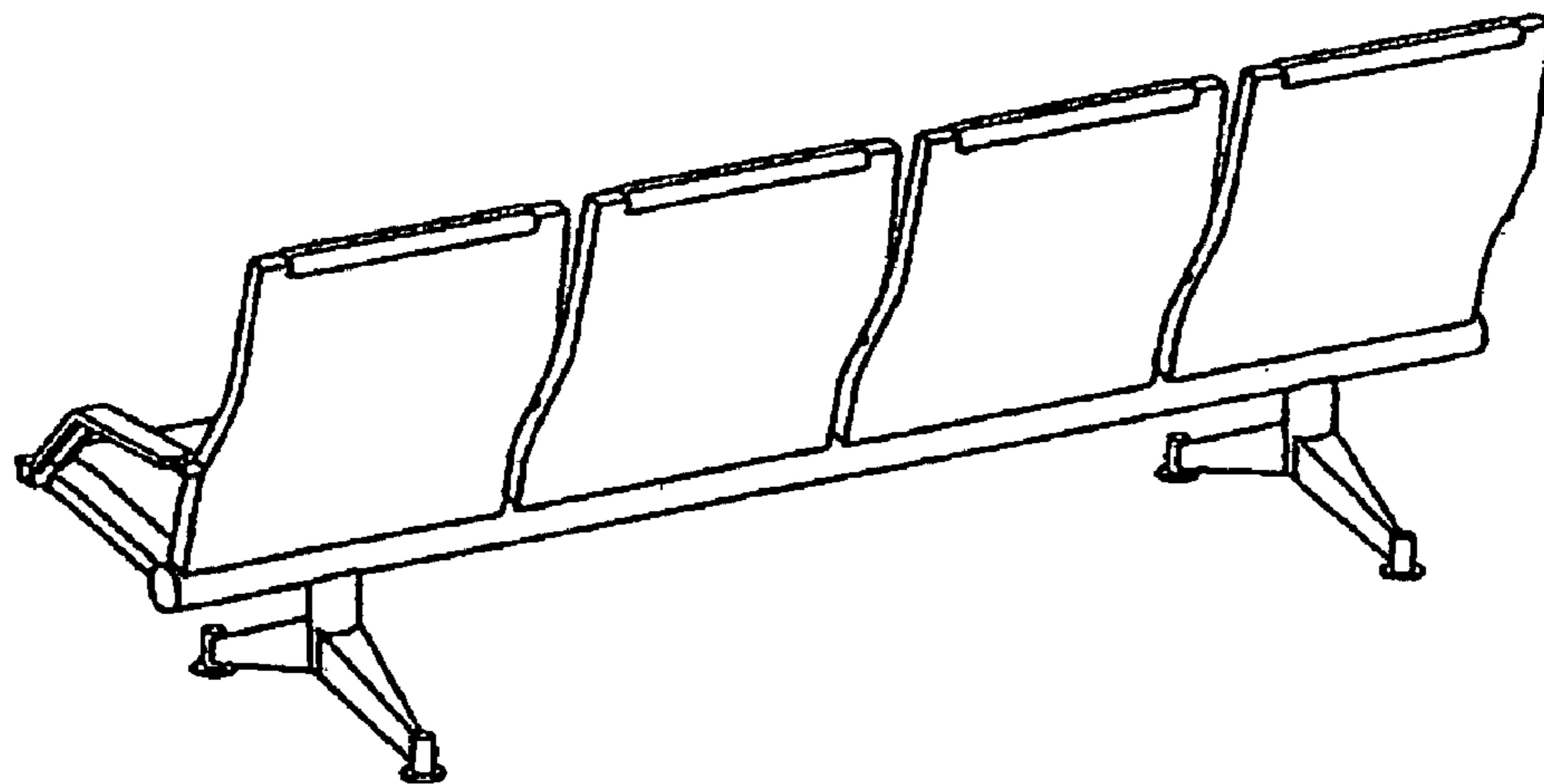

FIG. 2

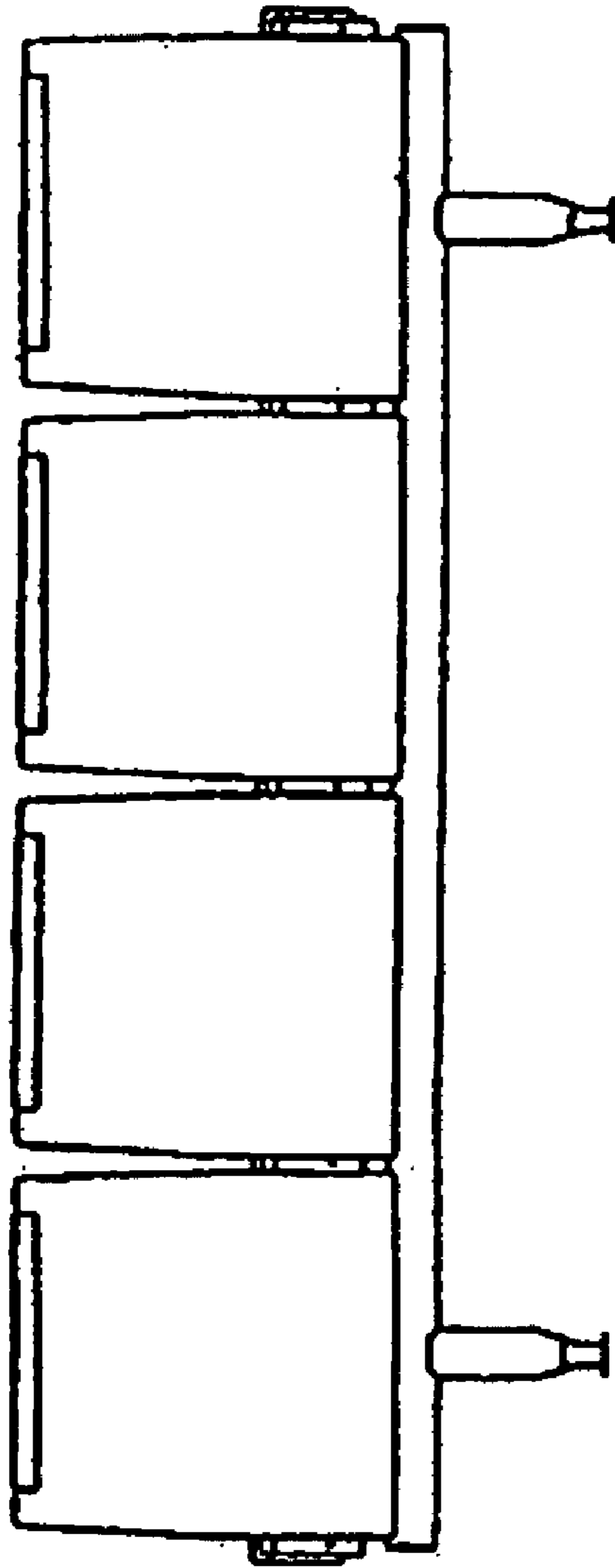

FIG. 4

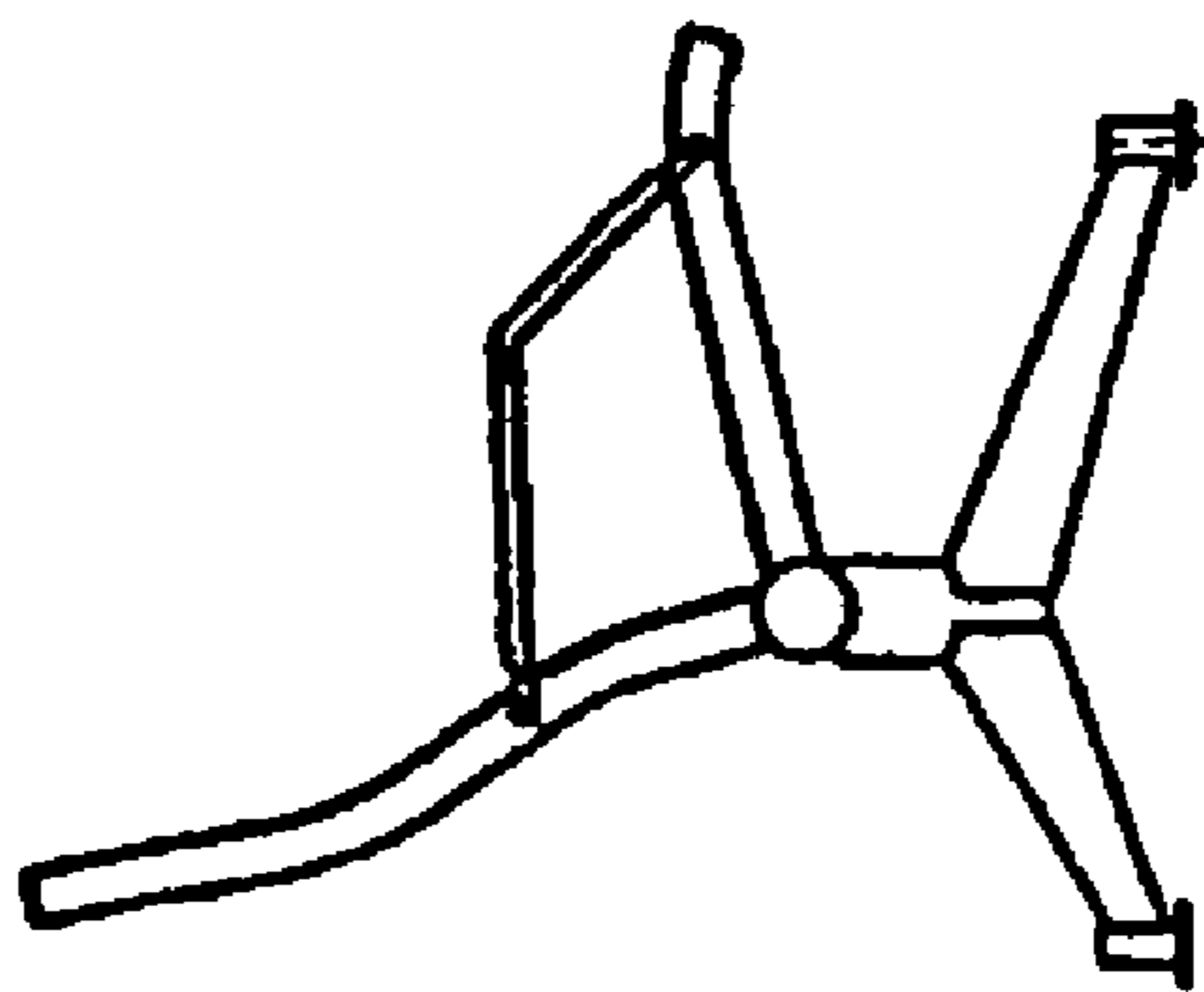

FIG. 3

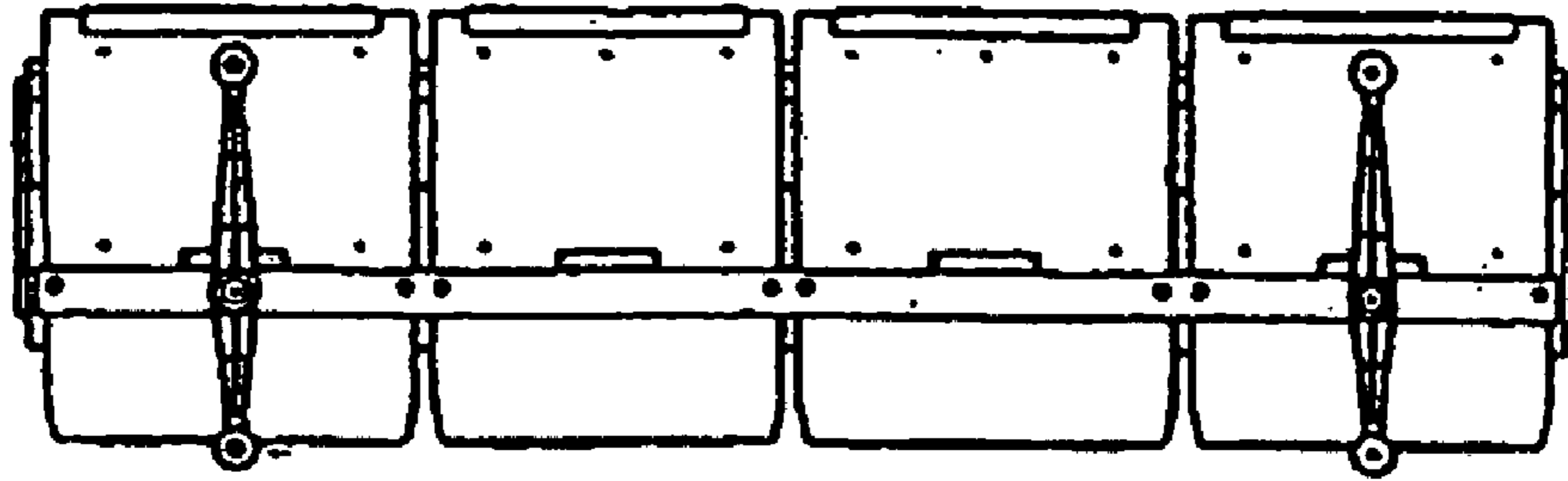

FIG. 5

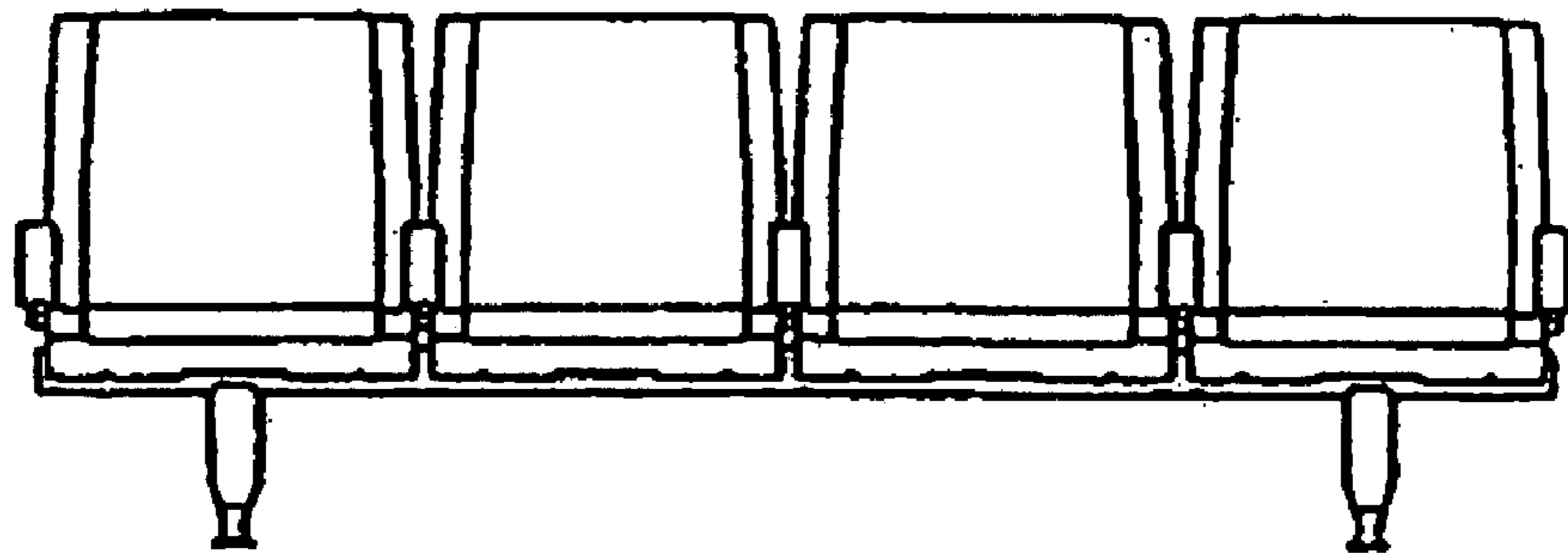

FIG. 6

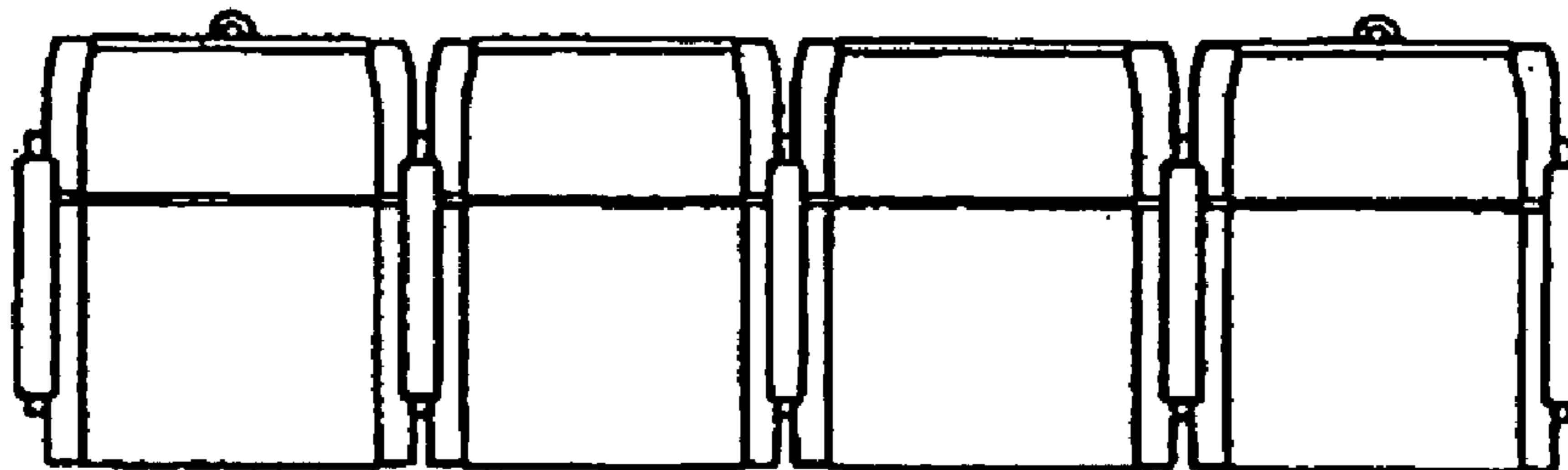

FIG. 7

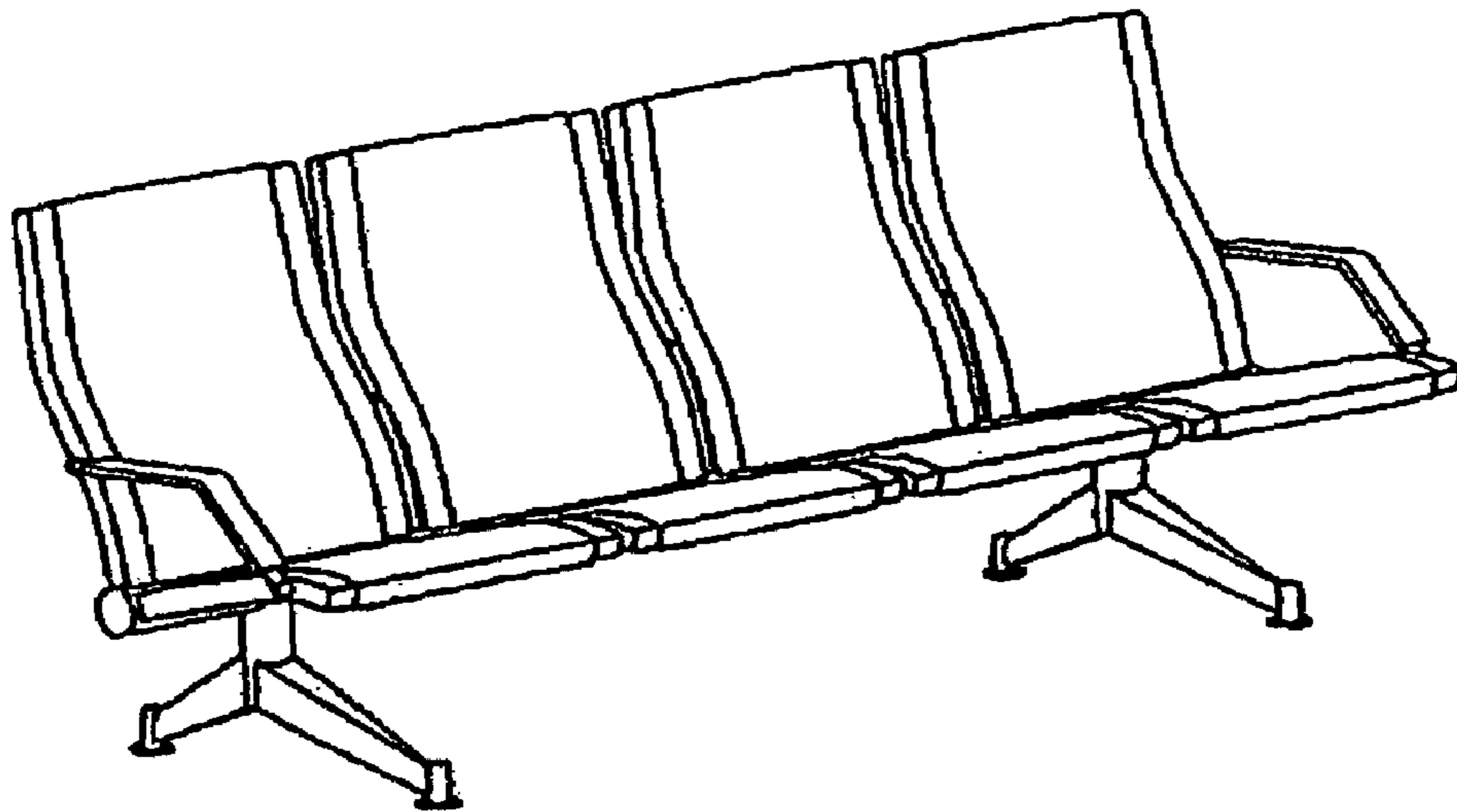

FIG. 8

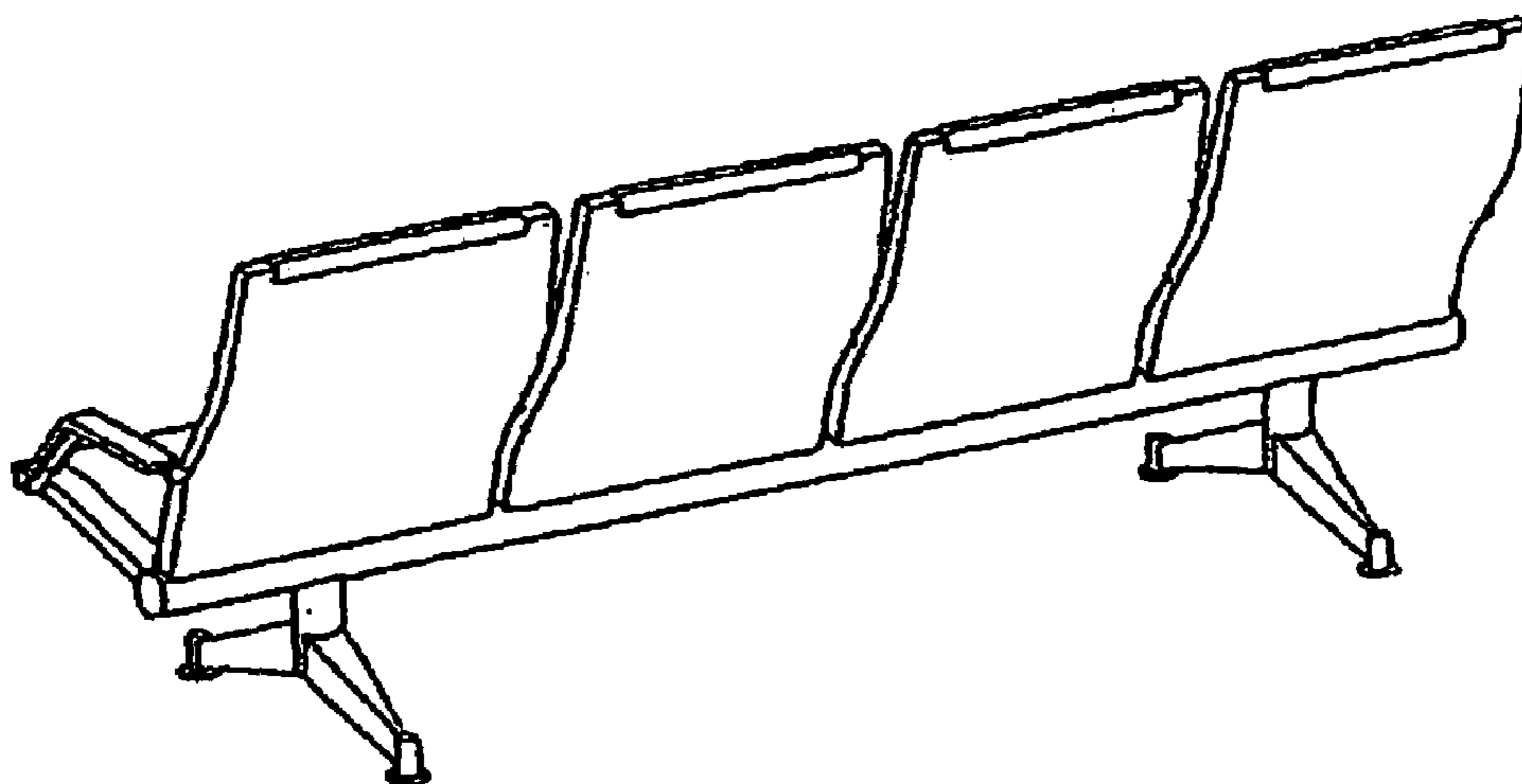

FIG. 9

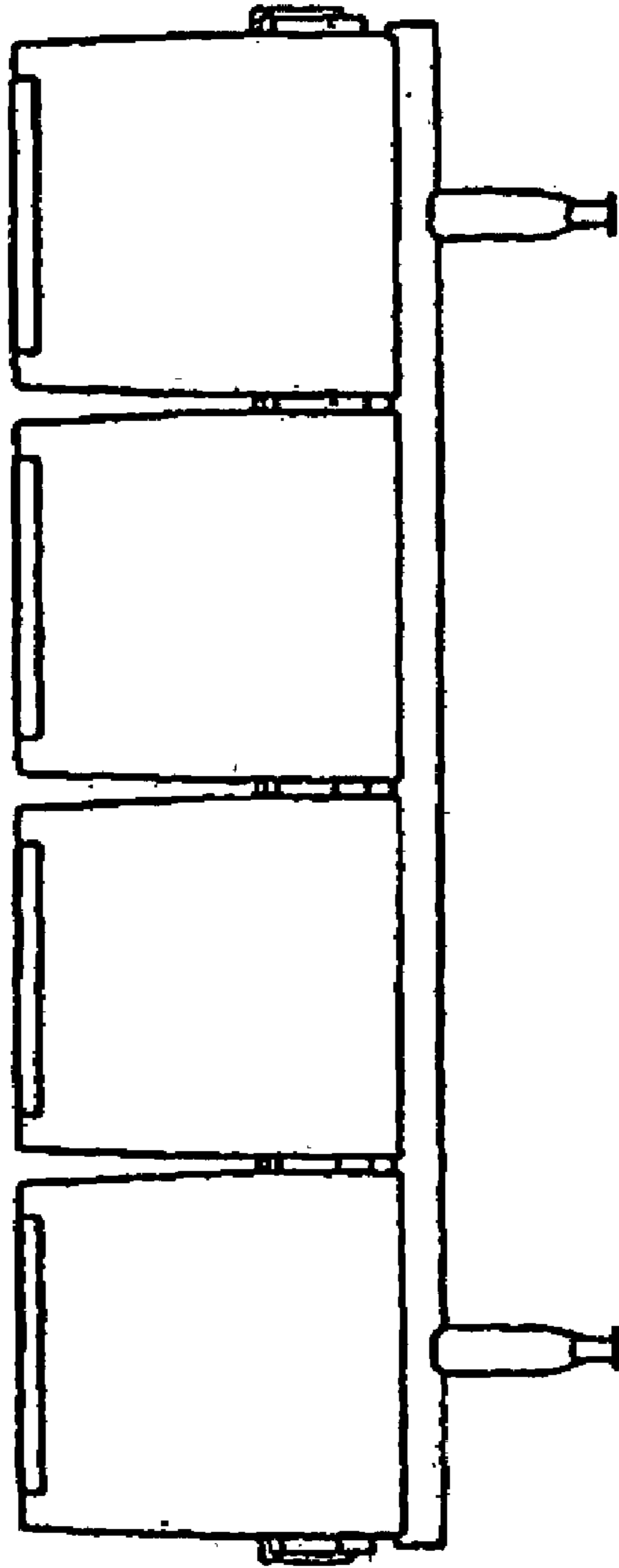

FIG. 11

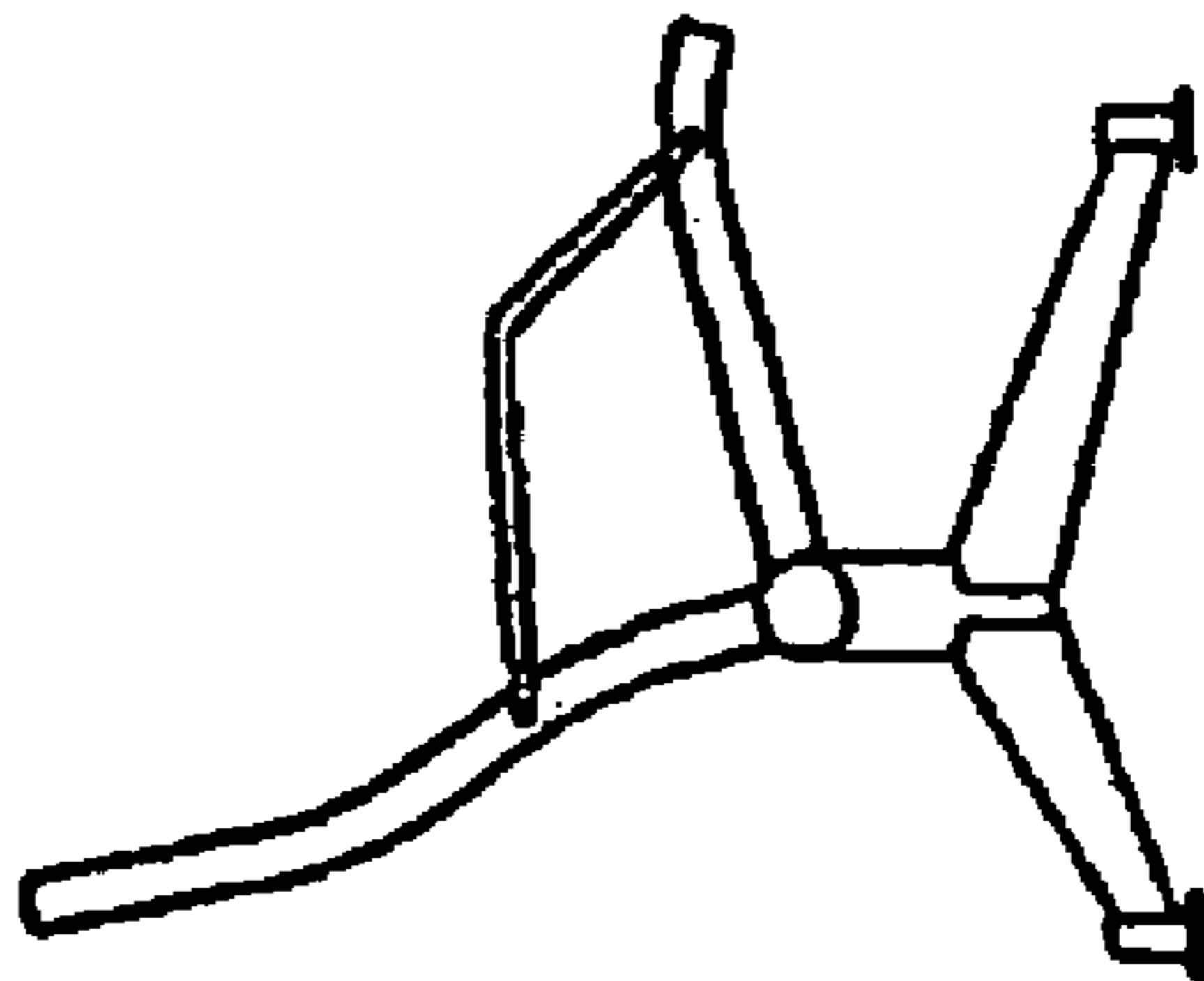

FIG. 10

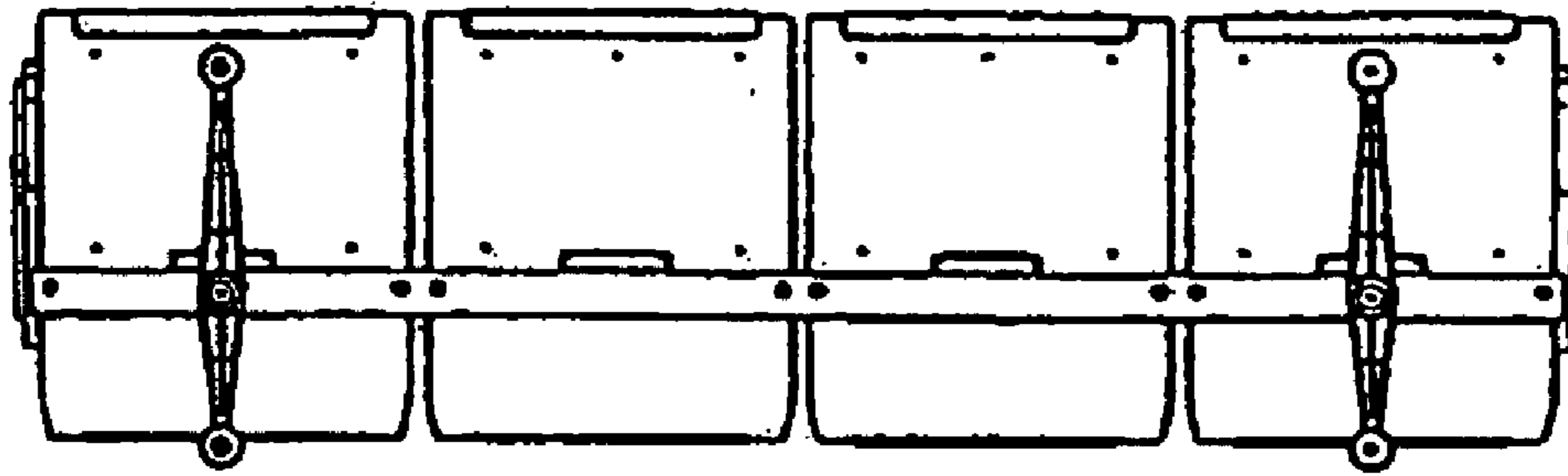

FIG. 12

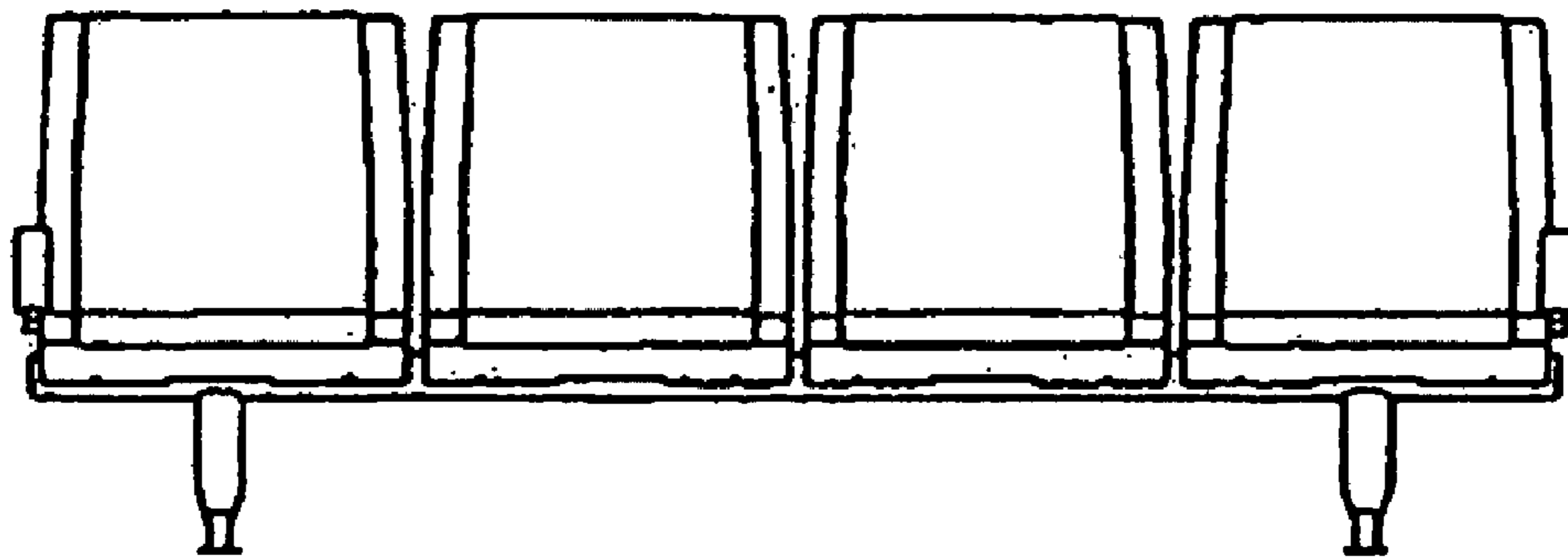

FIG. 13

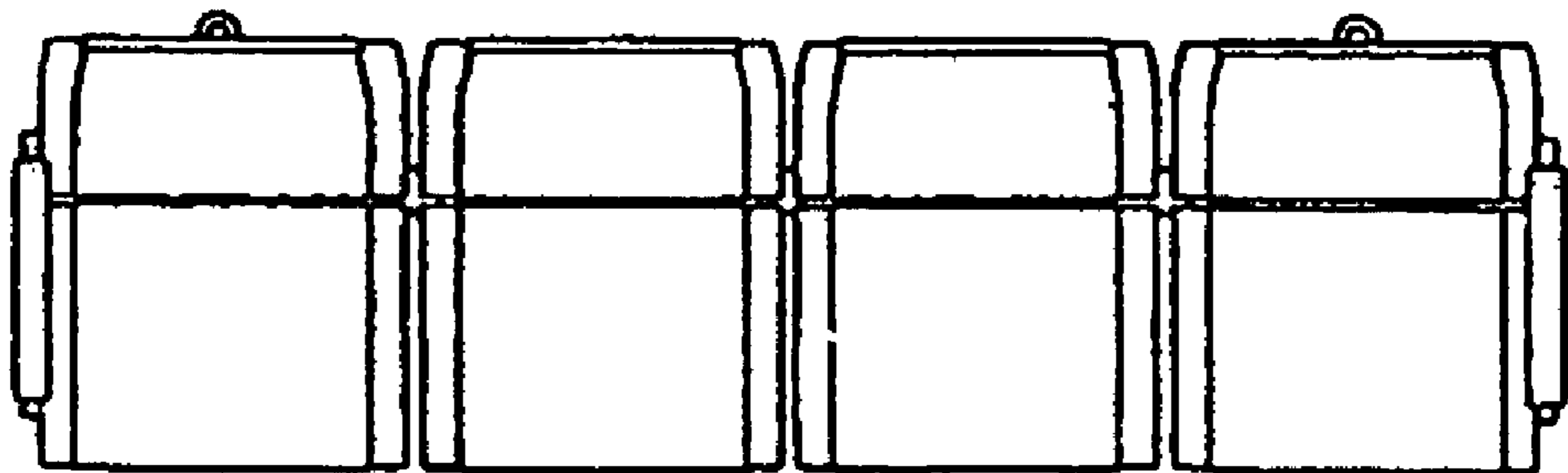

FIG. 14



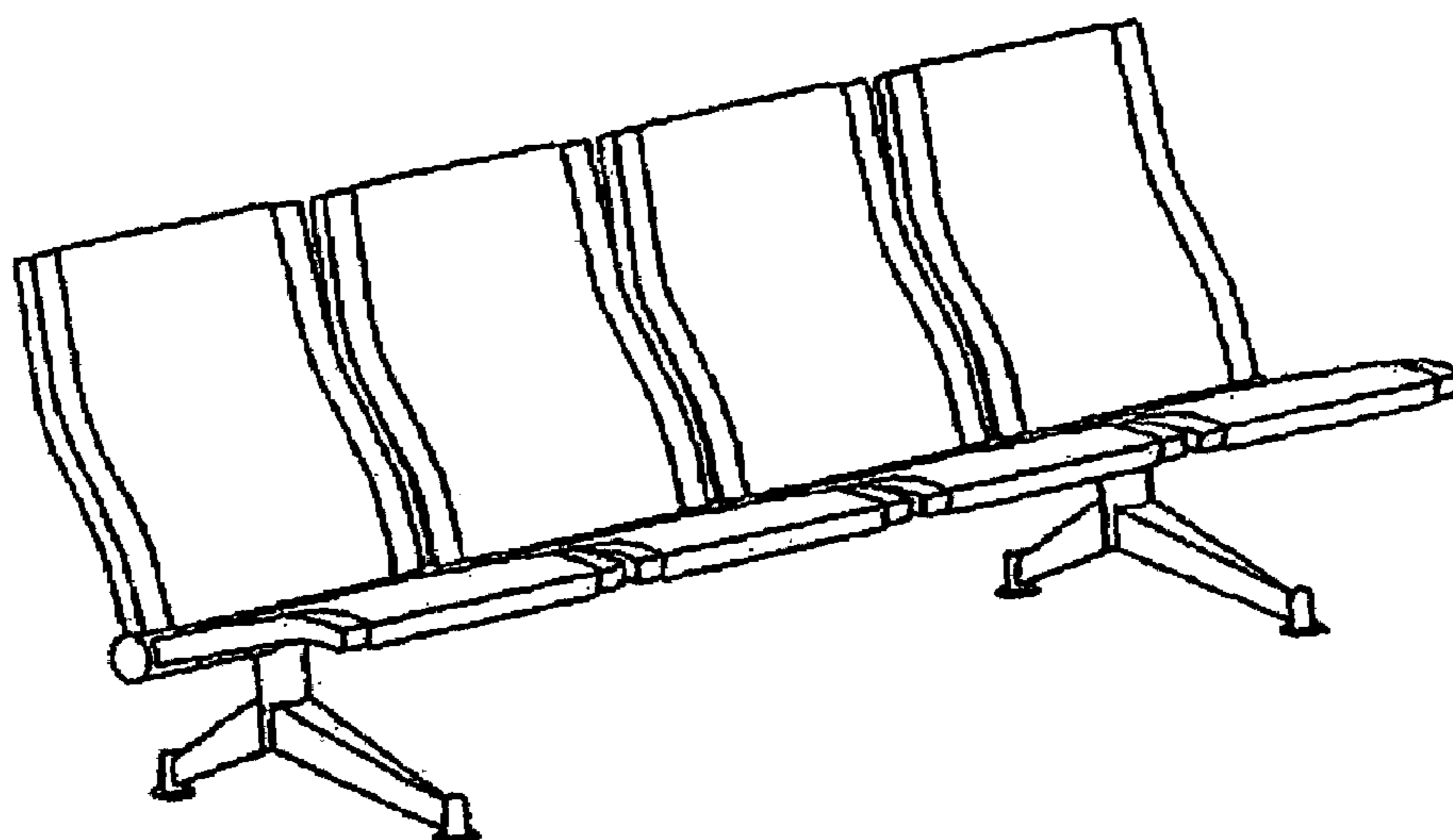

FIG. 15

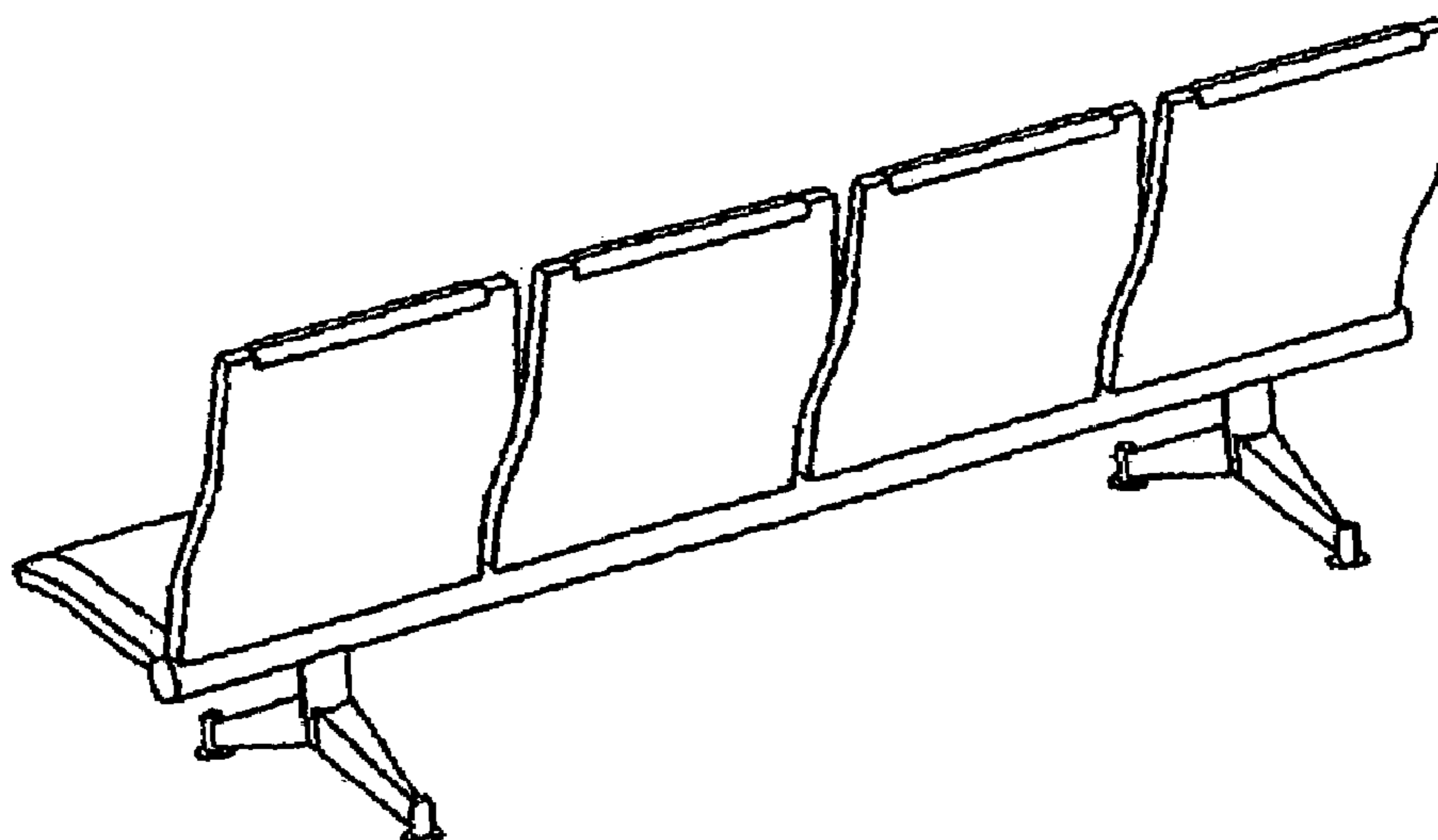

FIG. 16

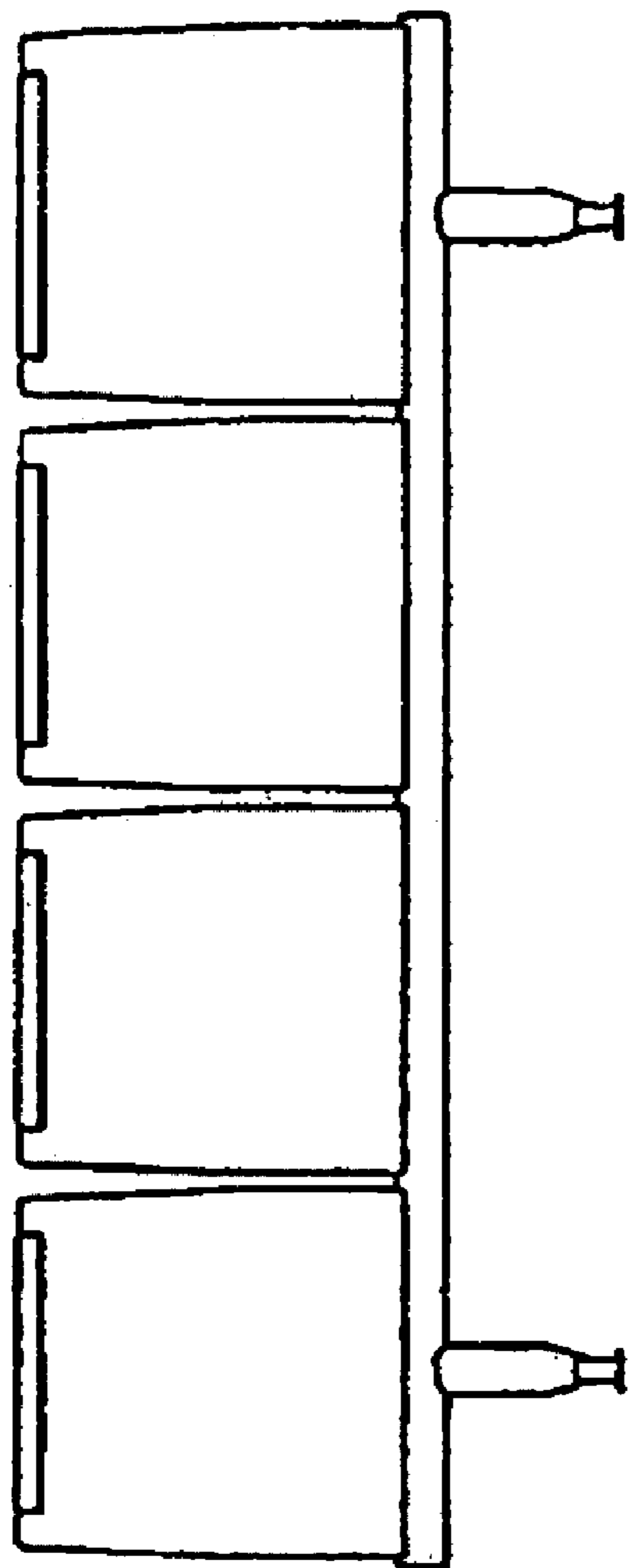

FIG. 18

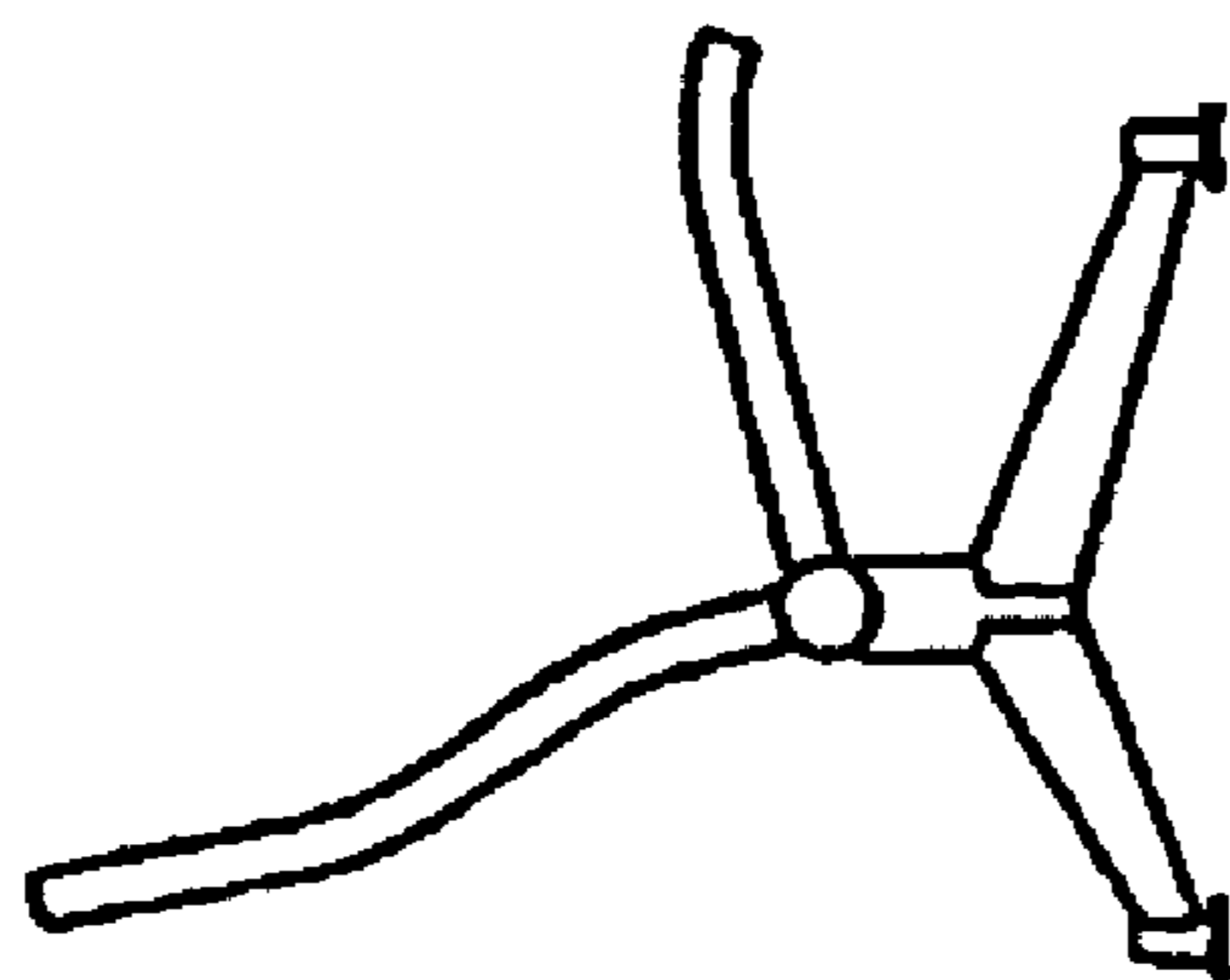

FIG. 17

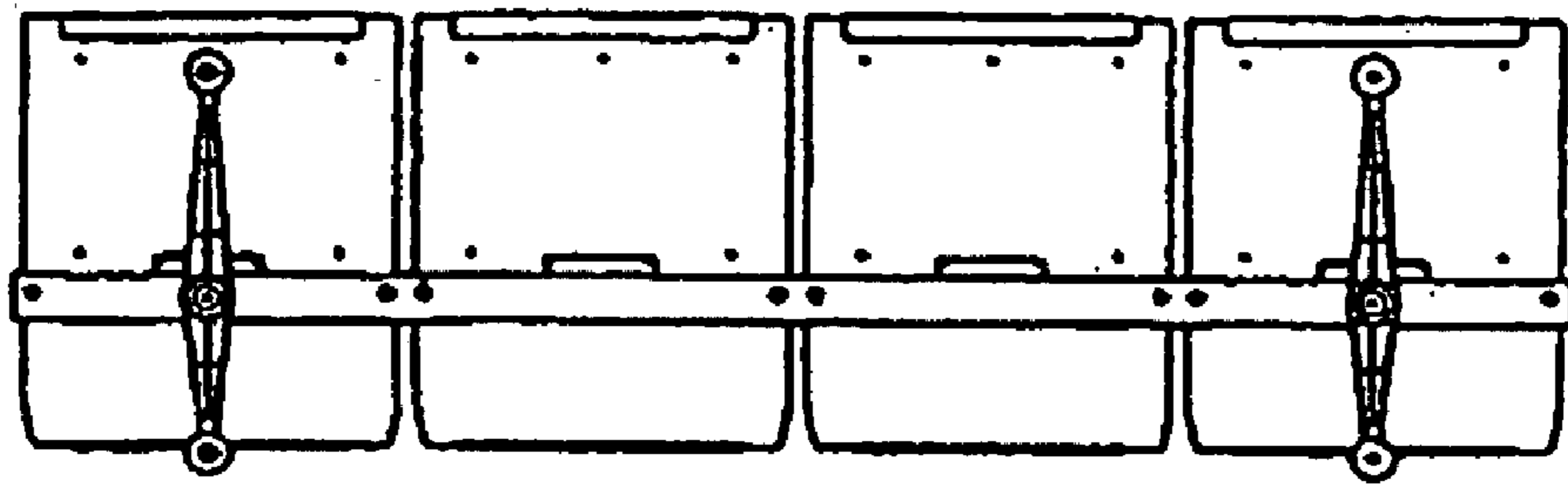

FIG. 19

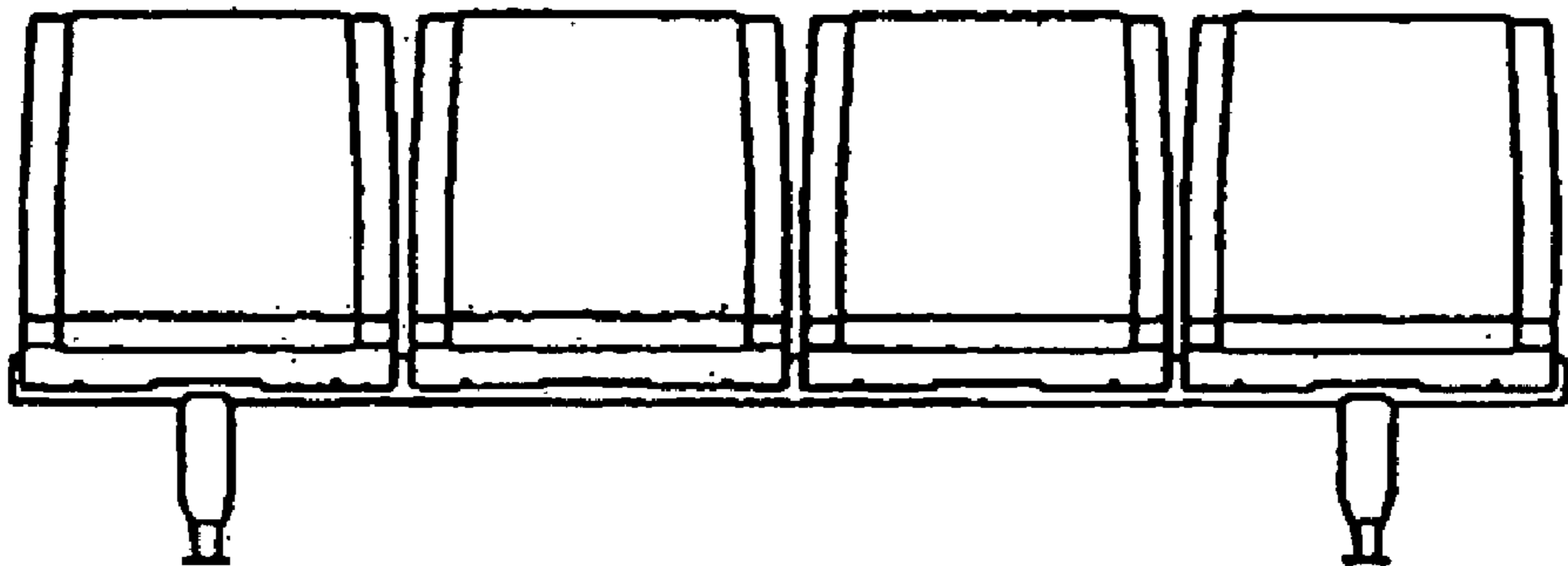

FIG. 20

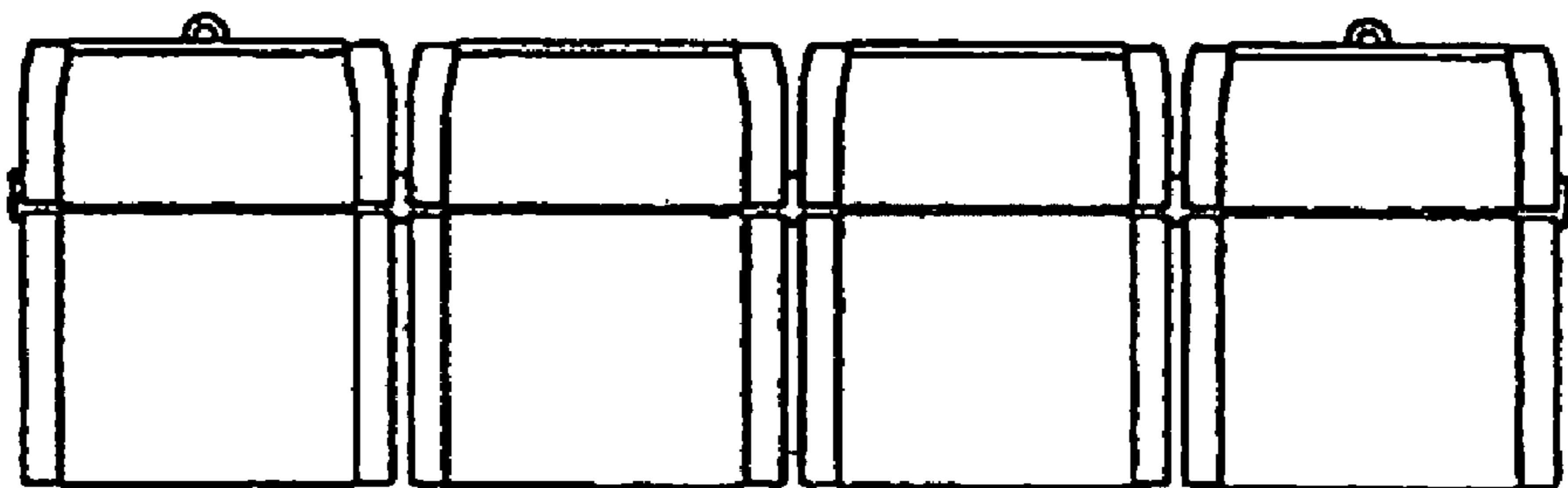

FIG. 21

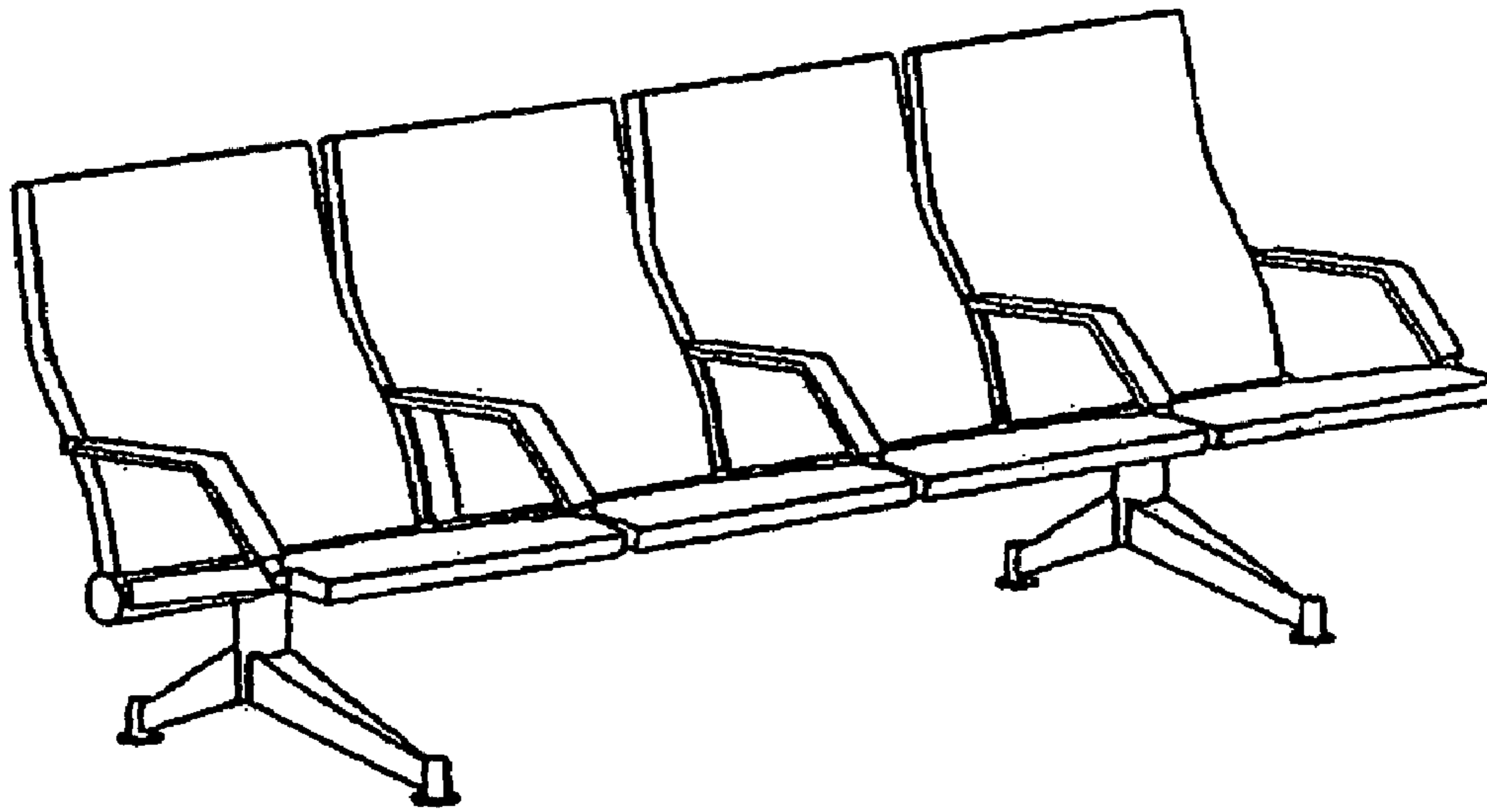

FIG. 22

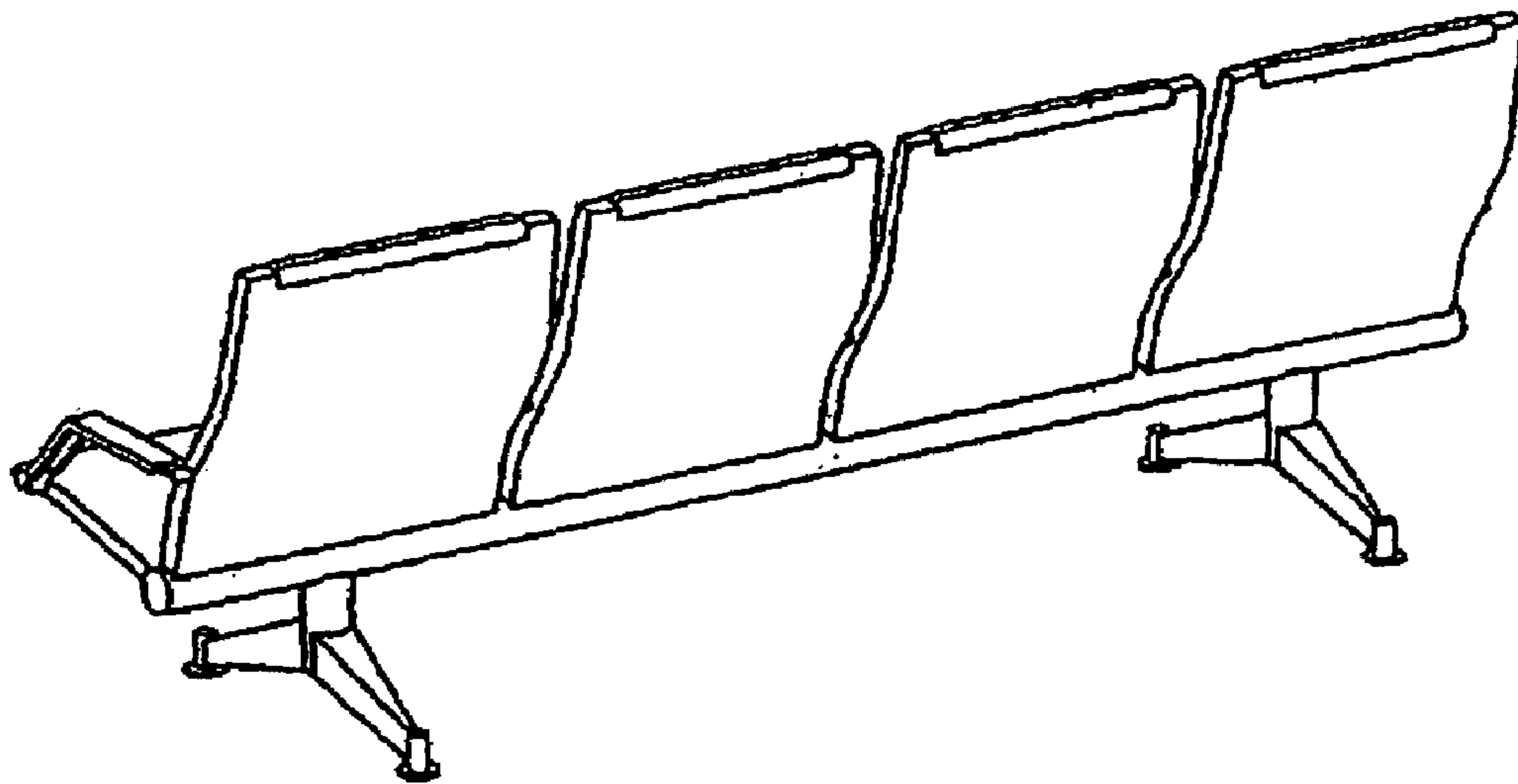

FIG. 23

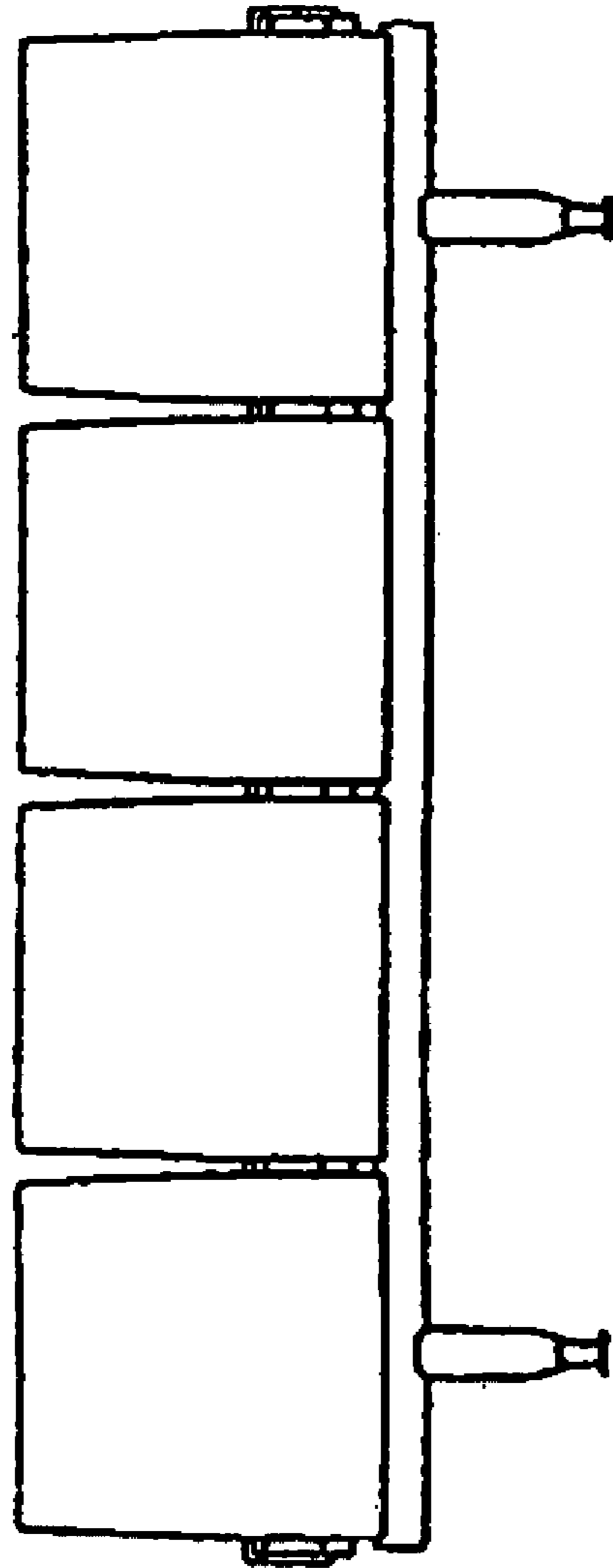

FIG. 25

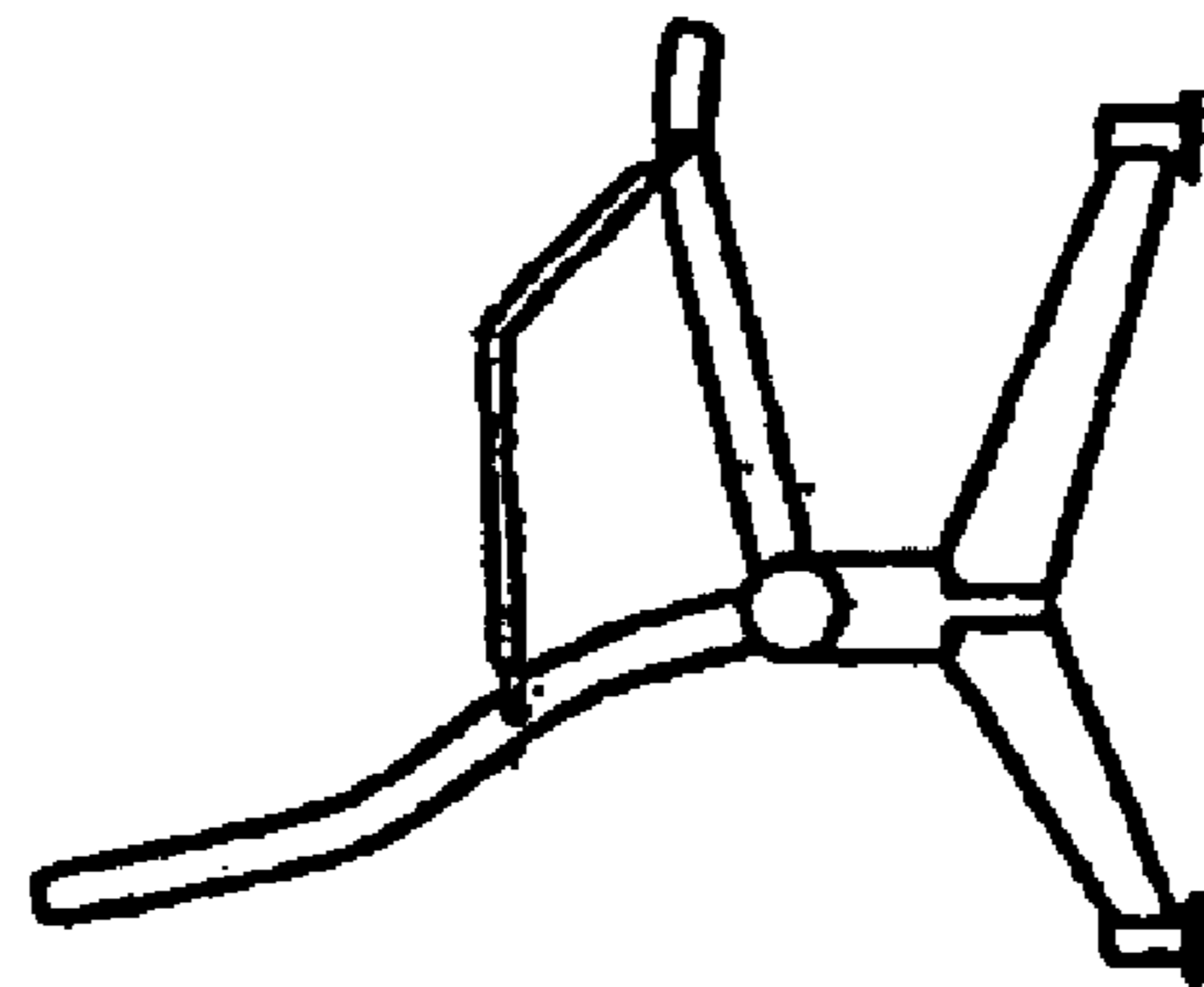

FIG. 24

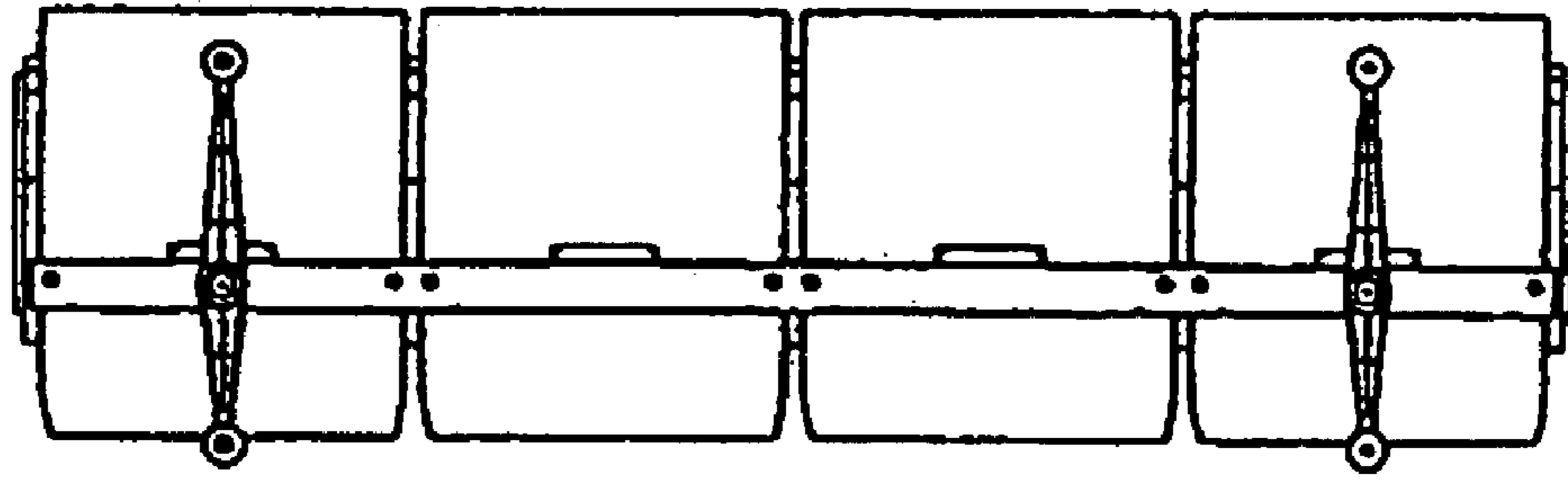

FIG. 26

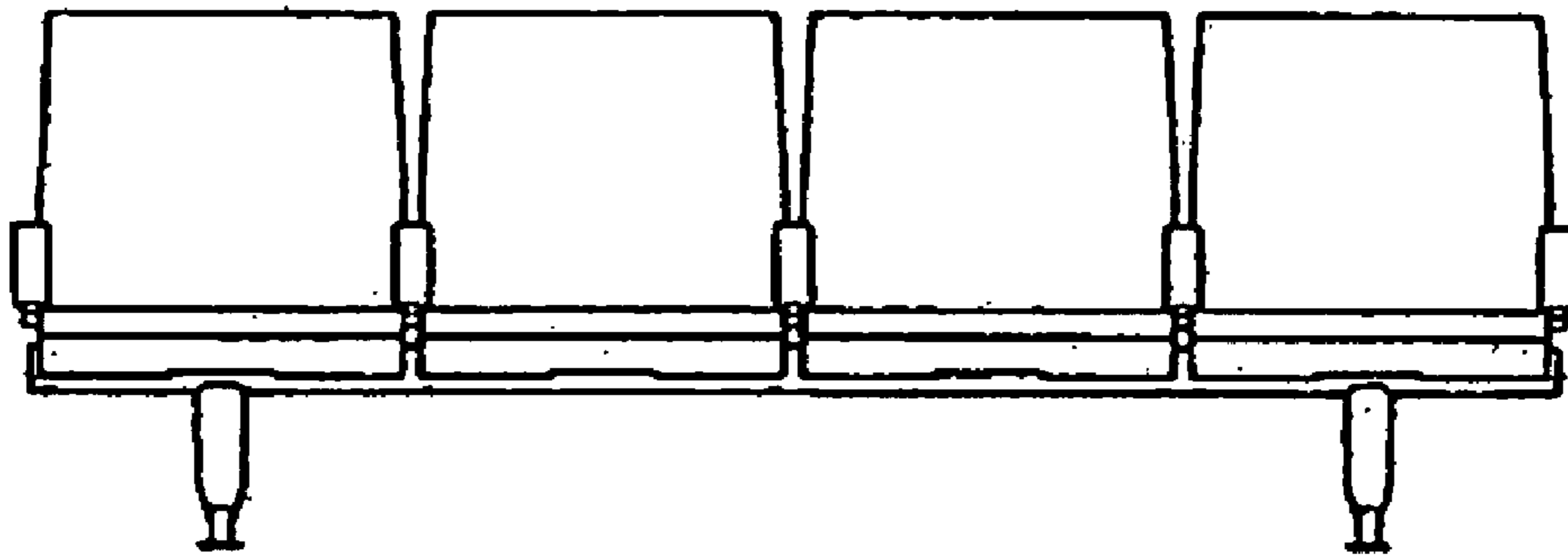

FIG. 27

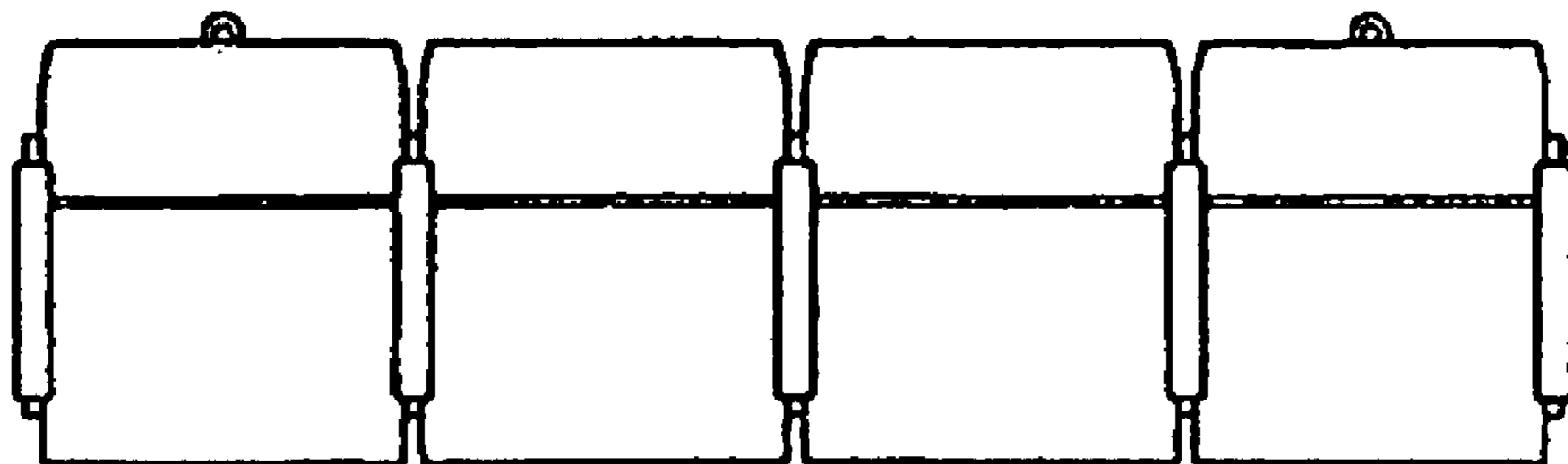

FIG. 28