



US00D575059S

(12) **United States Design Patent**
Cappiello et al.

(10) **Patent No.:** **US D575,059 S**
(45) **Date of Patent:** **** Aug. 19, 2008**

(54) **COMBINED COOLER AND CARRYING CASE**

(57) **CLAIM**

(75) Inventors: **Mark Cappiello**, West Hampton Dunes, NY (US); **Gina Mulhearn**, West Hampton Dunes, NY (US); **David C. Stowers**, Morristown, NJ (US)

The ornamental design for a combined cooler and carrying case, as shown and described.

(73) Assignee: **Measurement Limited**

DESCRIPTION

(**) Term: **14 Years**

(21) Appl. No.: **29/292,789**

(22) Filed: **Oct. 26, 2007**

(51) **LOC (8) Cl.** **03-01**

(52) **U.S. Cl.** **D3/283; D3/289; D7/607**

(58) **Field of Classification Search** D3/254,
D3/260, 262, 273–274, 276, 283–284, 287,
D3/289, 301, 904–905; D7/605, 607; 190/100,
190/103, 109, 111–113, 115; 206/216, 223,
206/315.11, 541, 545

See application file for complete search history.

FIG. 1 is a perspective view of a combined cooler and carrying case showing our new design;

FIG. 2 is a right side elevational view thereof;

FIG. 3 is a left side elevational view thereof;

FIG. 4 is a front elevational view thereof;

FIG. 5 is a rear side elevational view thereof;

FIG. 6 is a top elevational view thereof;

FIG. 7 is a bottom elevational view thereof;

FIG. 8 is a perspective view of the combined cooler and carrying case of FIG. 1 with the covering flaps open;

FIG. 9 is a right side elevational view of the combined cooler and carrying case of FIG. 8;

FIG. 10 is a left side elevational view of the combined cooler and carrying case of FIG. 8;

FIG. 11 is a front elevational view of the combined cooler and carrying case of FIG. 8;

FIG. 12 is a rear elevational view of the combined cooler and carrying case of FIG. 8;

FIG. 13 is a top elevational view of the combined cooler and carrying case of FIG. 8; and,

FIG. 14 is a bottom elevational view of the combined cooler and carrying case of FIG. 8.

The matter shown in broken lines is illustrative of environment only and forms no part of the claimed design.

The cross-hatching shown in all figures is understood to represent a pattern that continue across the surfaces on which it is shown.

(56) **References Cited**

U.S. PATENT DOCUMENTS

4,266,407 A	5/1981	Gibson	
4,281,520 A	8/1981	Norwood	
4,286,440 A	9/1981	Taylor	
4,351,165 A	9/1982	Gottsegen et al.	
4,413,481 A	11/1983	Thomas	
4,459,827 A	7/1984	Rhodes	
4,468,933 A	9/1984	Christopher	
4,516,409 A	5/1985	Hobbs, Jr. et al.	
D281,694 S	12/1985	Ryan, Jr.	
D284,333 S *	6/1986	Huston	D3/268
D285,748 S *	9/1986	Feinberg et al.	D3/286

(Continued)

Primary Examiner—Philip Hyder

Assistant Examiner—RoseLynne Cody

(74) *Attorney, Agent, or Firm*—Howard IP Law Group, PC

1 Claim, 8 Drawing Sheets

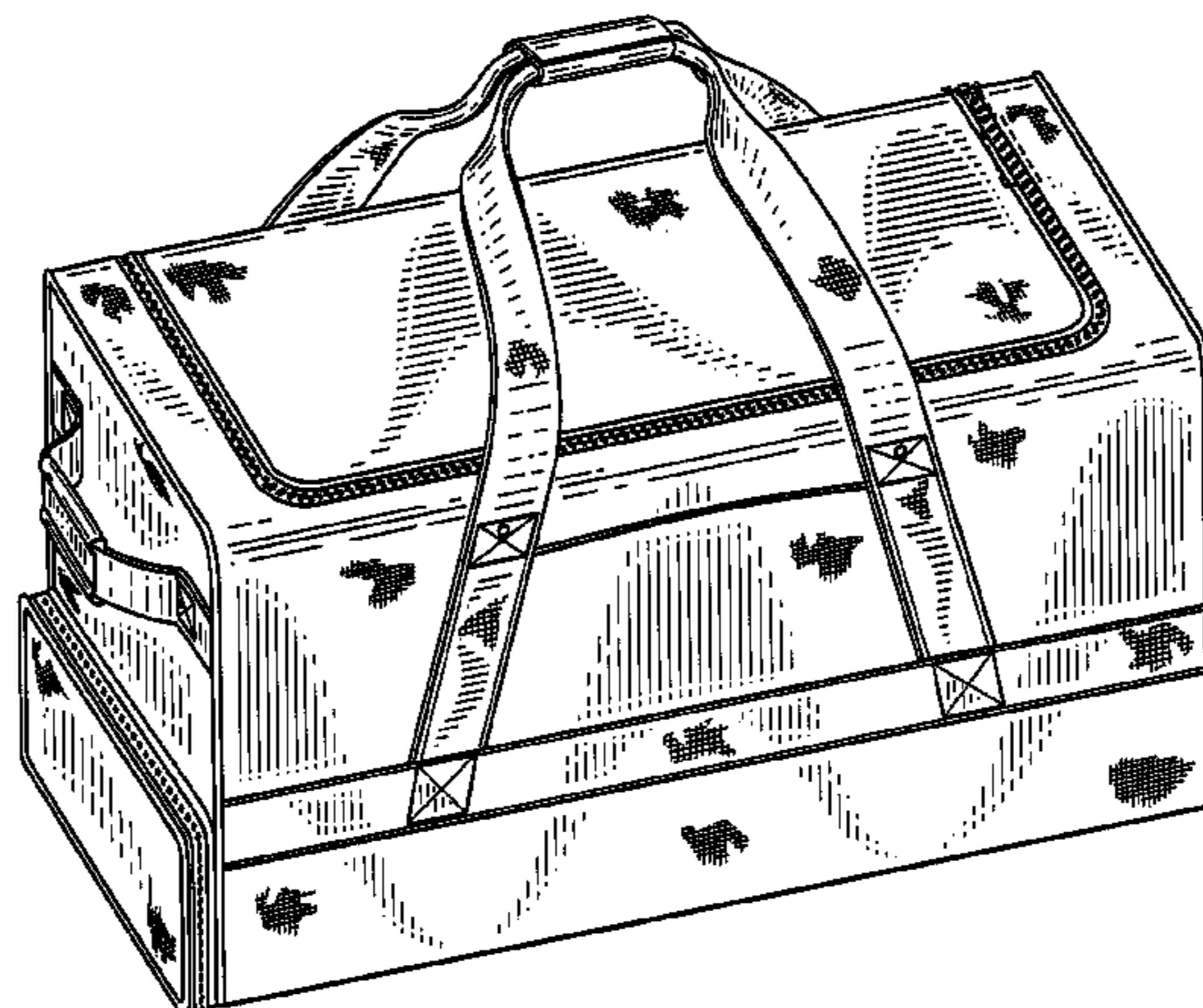

US D575,059 S

Page 2

U.S. PATENT DOCUMENTS

4,633,678	A	1/1987	Lea et al.				
4,719,764	A	1/1988	Cook				
4,721,237	A	1/1988	Leslie				
4,773,515	A *	9/1988	Kotkins, Jr.	190/103			
D299,406	S *	1/1989	Jacober	D7/332			
4,802,344	A	2/1989	Livingston et al.				
4,805,776	A *	2/1989	Namgyal et al.	206/523			
4,811,858	A	3/1989	Augur				
4,858,444	A	8/1989	Scott				
4,871,079	A	10/1989	Doucette et al.				
D311,452	S *	10/1990	Ehret	D3/286			
5,005,679	A *	4/1991	Hjelle	190/110			
D317,081	S *	5/1991	King	D3/287			
5,140,833	A	8/1992	Whalen				
5,216,900	A	6/1993	Jones				
D340,621	S *	10/1993	Melk	D7/607			
5,251,460	A	10/1993	DeMarco et al.				
D340,840	S *	11/1993	Melk	D7/607			
5,277,328	A	1/1994	Tocco				
5,301,519	A	4/1994	Howorka				
5,303,863	A	4/1994	Arasim				
5,403,095	A *	4/1995	Melk	383/110			
5,413,199	A *	5/1995	Clement	190/108			
5,421,159	A	6/1995	Stokes				
D371,051	S *	6/1996	Melk	D7/607			
D371,052	S *	6/1996	Melk	D7/607			
D376,044	S *	12/1996	Trawick et al.	D3/283			
5,595,429	A	1/1997	Kennedy				
5,640,855	A	6/1997	Crescenzo et al.				
D387,626	S *	12/1997	Melk	D7/605			
5,758,513	A	6/1998	Smith				
D398,083	S *	9/1998	Martz	D30/109			
5,931,019	A	8/1999	White et al.				
D416,680	S *	11/1999	Latshaw	D3/286			
6,067,813	A	5/2000	Smith				
6,105,844	A	8/2000	Walters et al.				
6,216,487	B1	4/2001	Gano, III				
6,234,677	B1 *	5/2001	Mogil	383/110			
D446,937	S *	8/2001	Mogil	D3/301			
6,269,965	B1	8/2001	White et al.				
6,394,325	B1	5/2002	Taylor				
6,409,066	B1	6/2002	Schneider et al.				
6,427,475	B1	8/2002	Defelice et al.				
D464,235	S *	10/2002	Jeong	D7/607			
6,505,479	B2	1/2003	Defelice et al.				
D478,782	S *	8/2003	Li	D7/607			
6,601,745	B2	8/2003	Tyrer				
6,644,063	B2 *	11/2003	Mogil	62/457.2			
6,675,599	B1	1/2004	Correia				
6,688,470	B2 *	2/2004	Dege et al.	206/545			
6,705,108	B2	3/2004	Defelice et al.				
6,736,309	B1	5/2004	Westerman et al.				
6,789,693	B2	9/2004	Lassiter				
6,821,019	B2 *	11/2004	Mogil	383/110			
6,837,420	B2	1/2005	Westerman et al.				
6,976,370	B2	12/2005	Fiene				
D523,243	S *	6/2006	Nashmy	D3/285			
D526,484	S *	8/2006	Flint	D3/283			
7,128,369	B2	10/2006	Boggs et al.				
7,147,125	B1	12/2006	Slovak et al.				
7,168,263	B1	1/2007	Zenner				
D548,408	S *	8/2007	Martz	D30/109			
7,309,106	B2	12/2007	Stallman				
D560,450	S *	1/2008	Tagliati et al.	D7/709			
7,313,927	B2	1/2008	Barker				
2006/0254952	A1 *	11/2006	Trevino et al.	206/581			

* cited by examiner

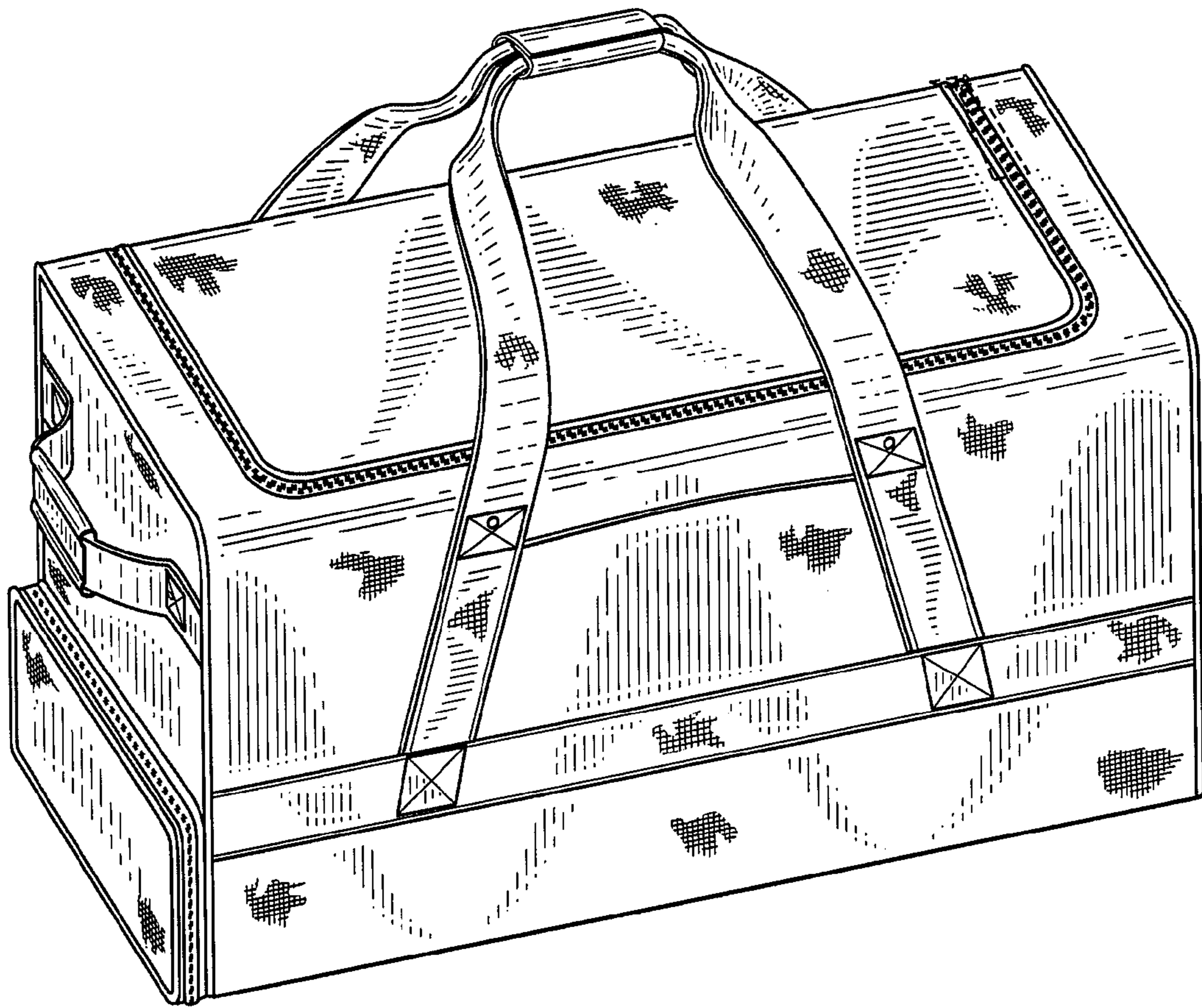

FIG. 1

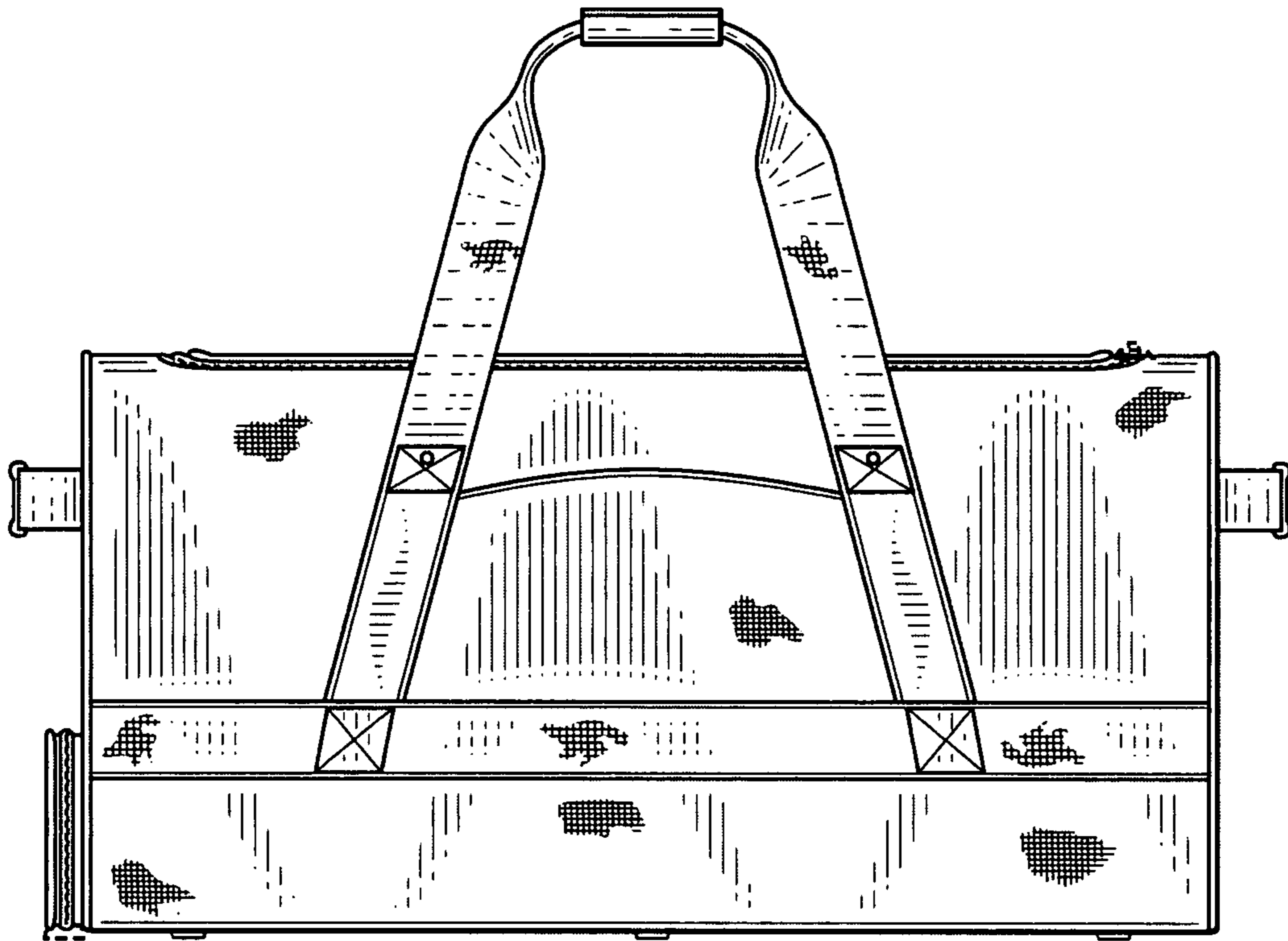

FIG. 2

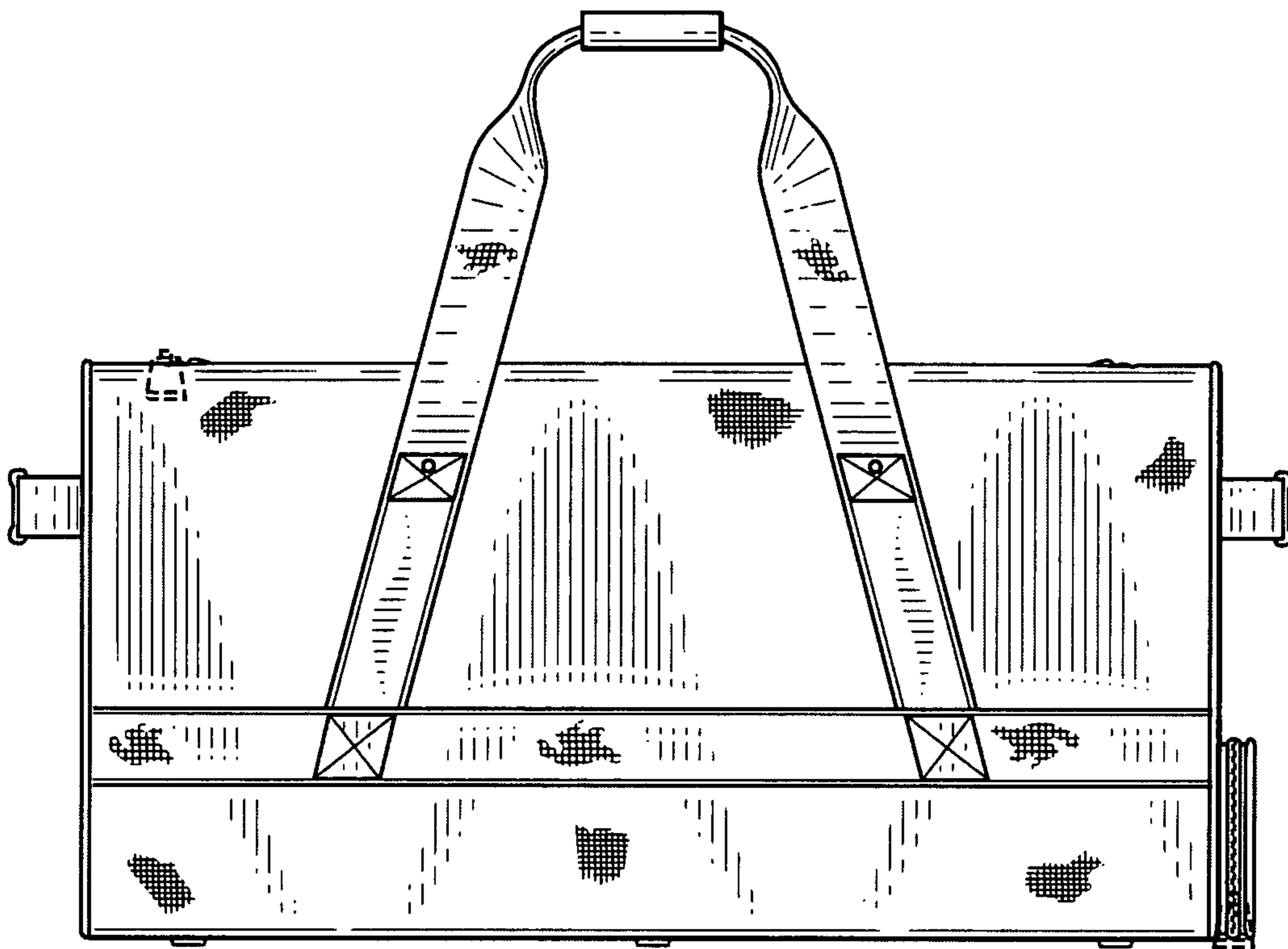

FIG. 3

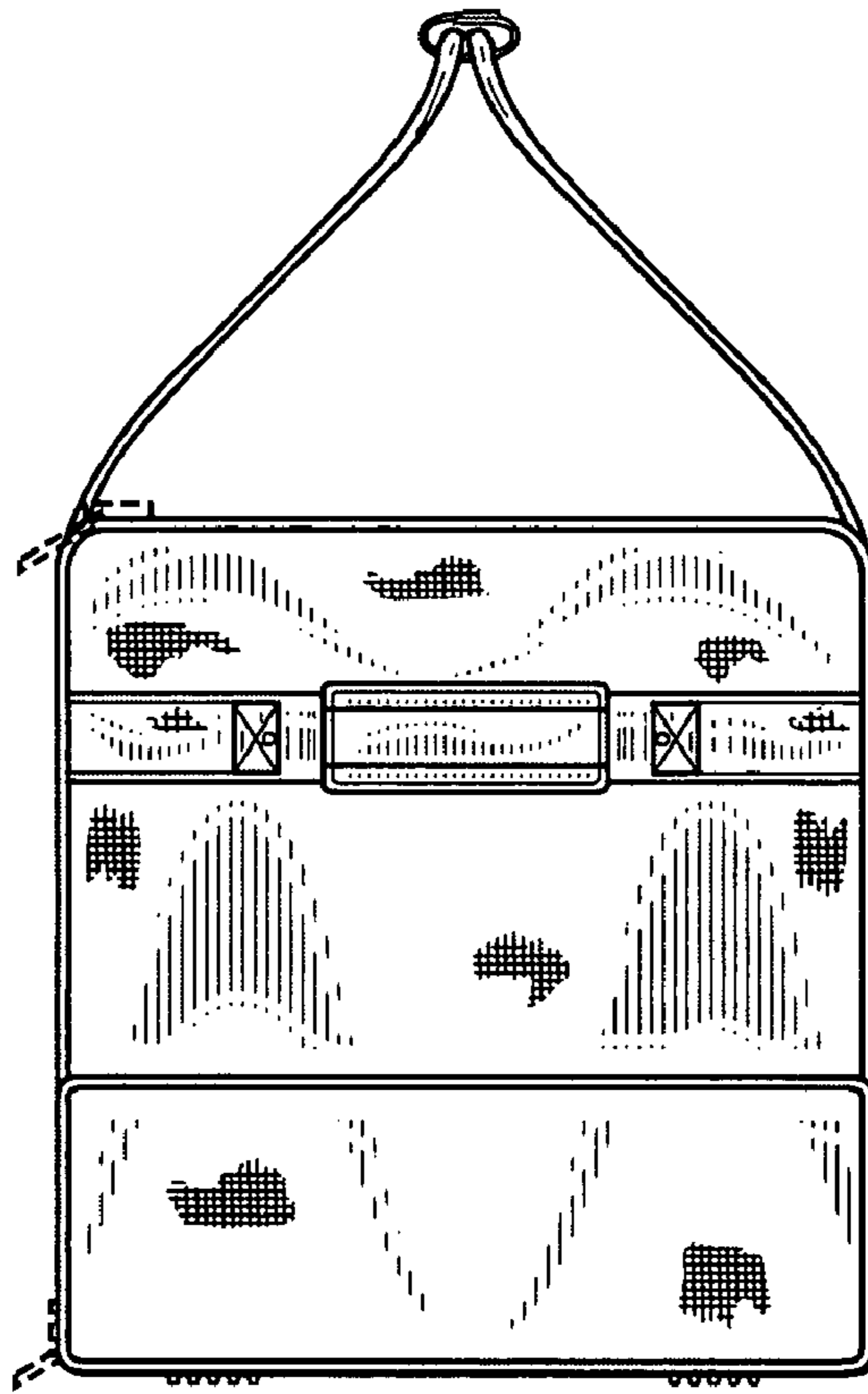

FIG. 4

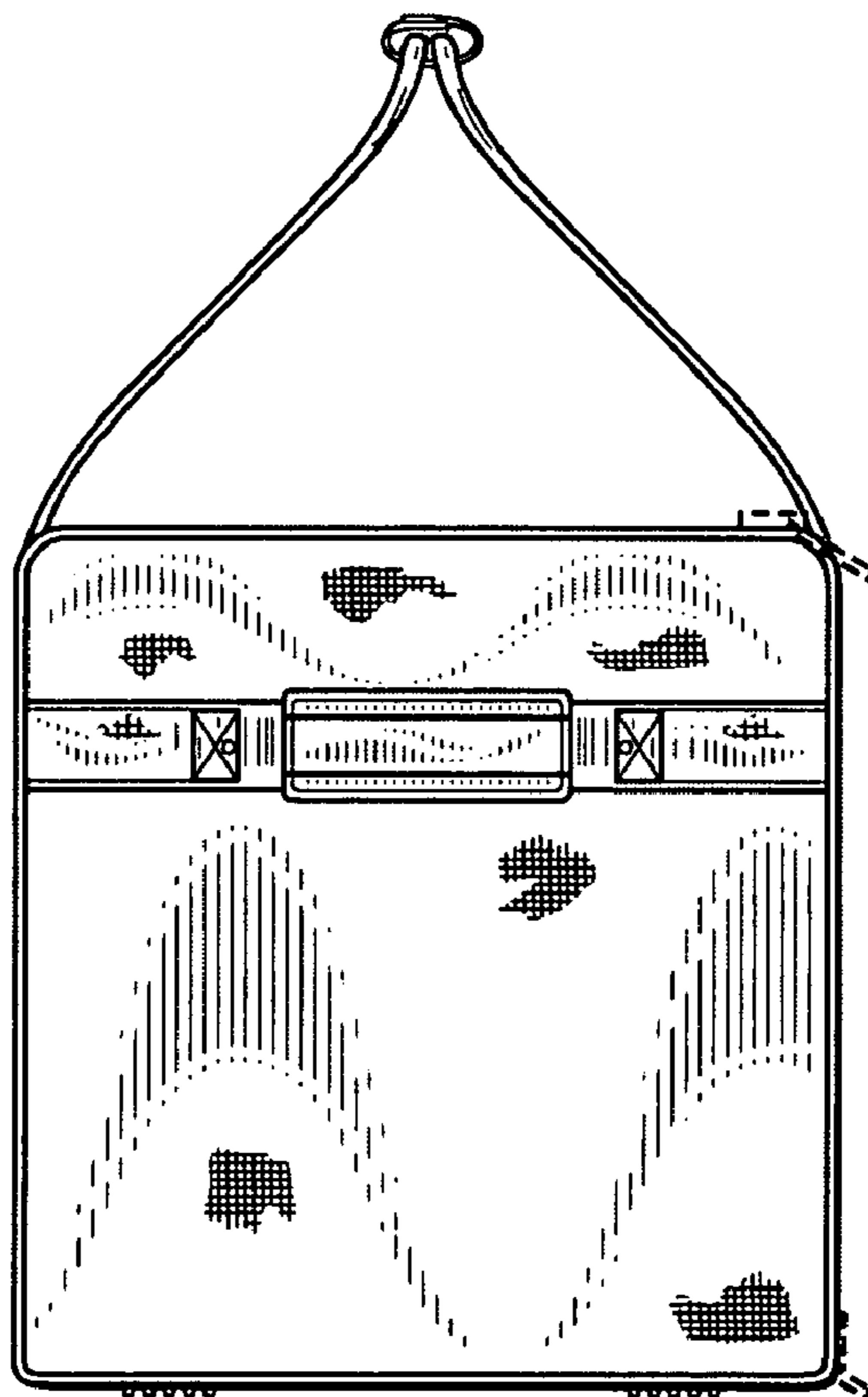

FIG. 5

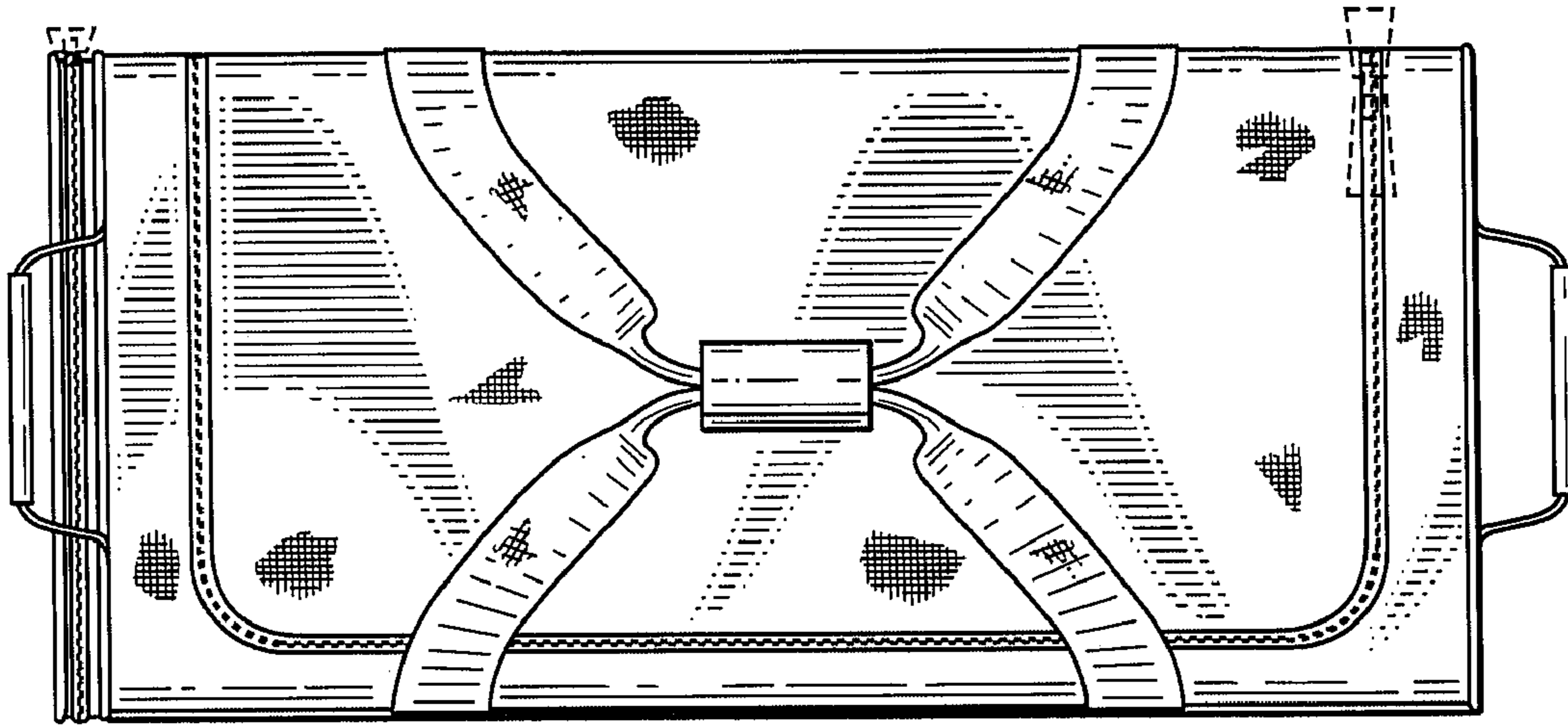

FIG. 6

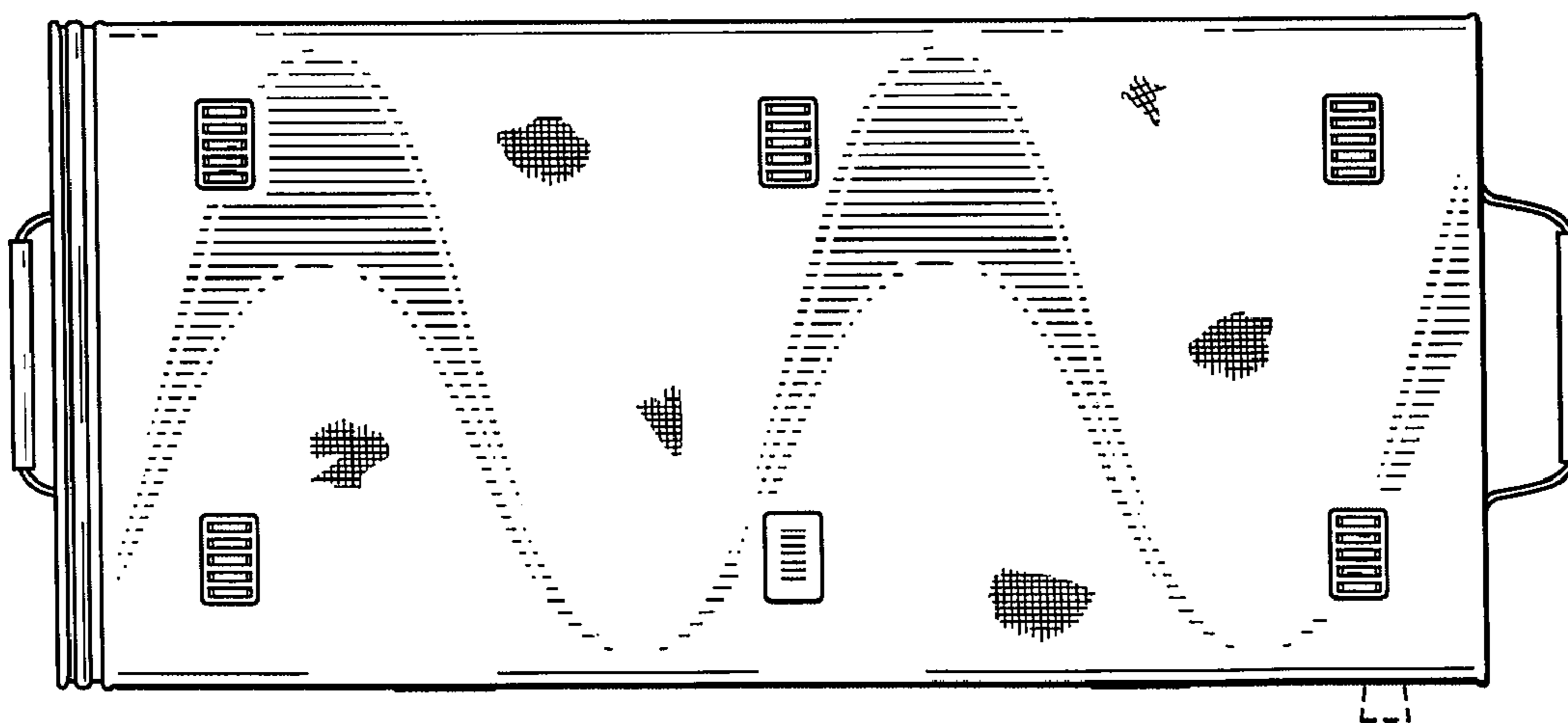

FIG. 7

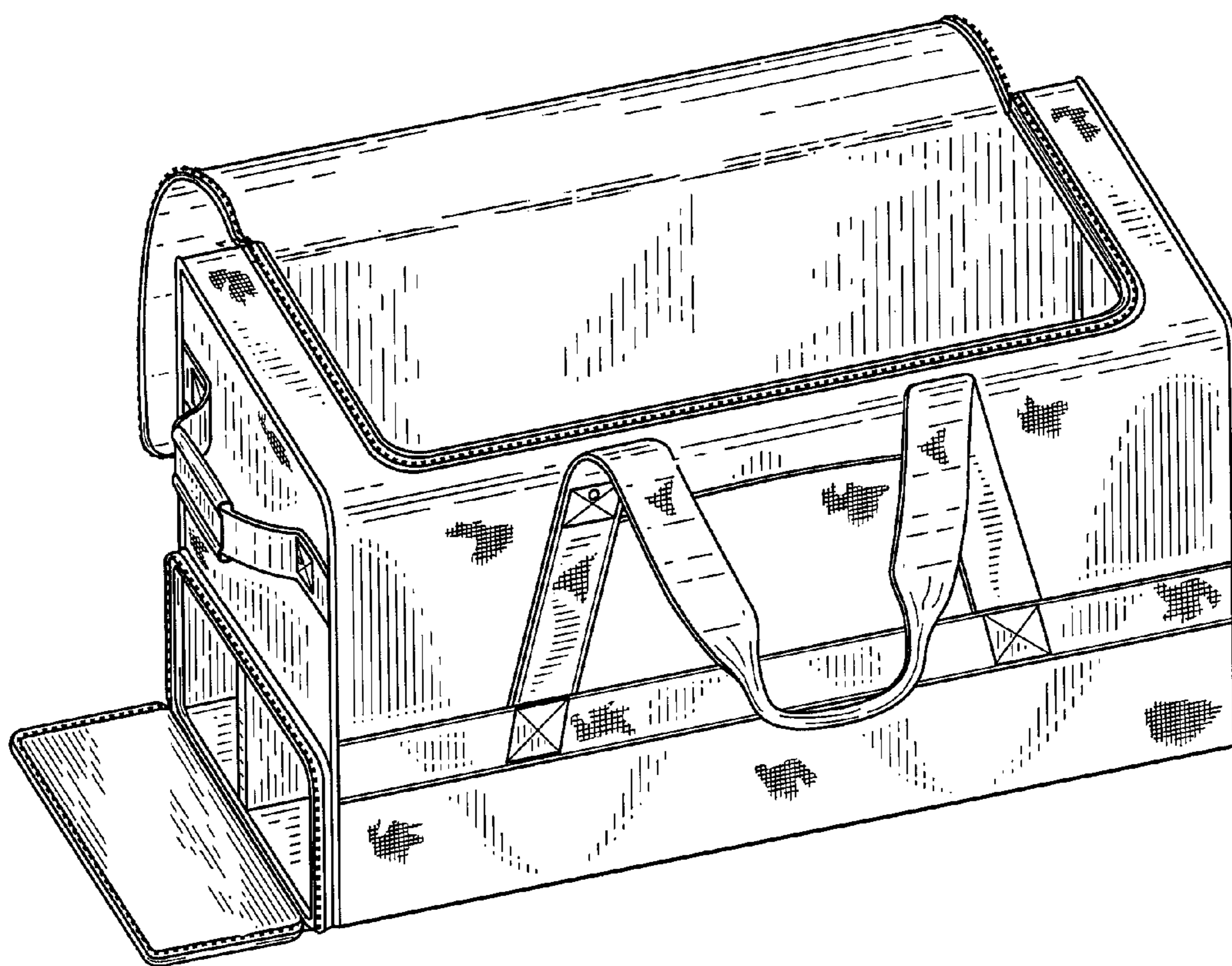

FIG. 8

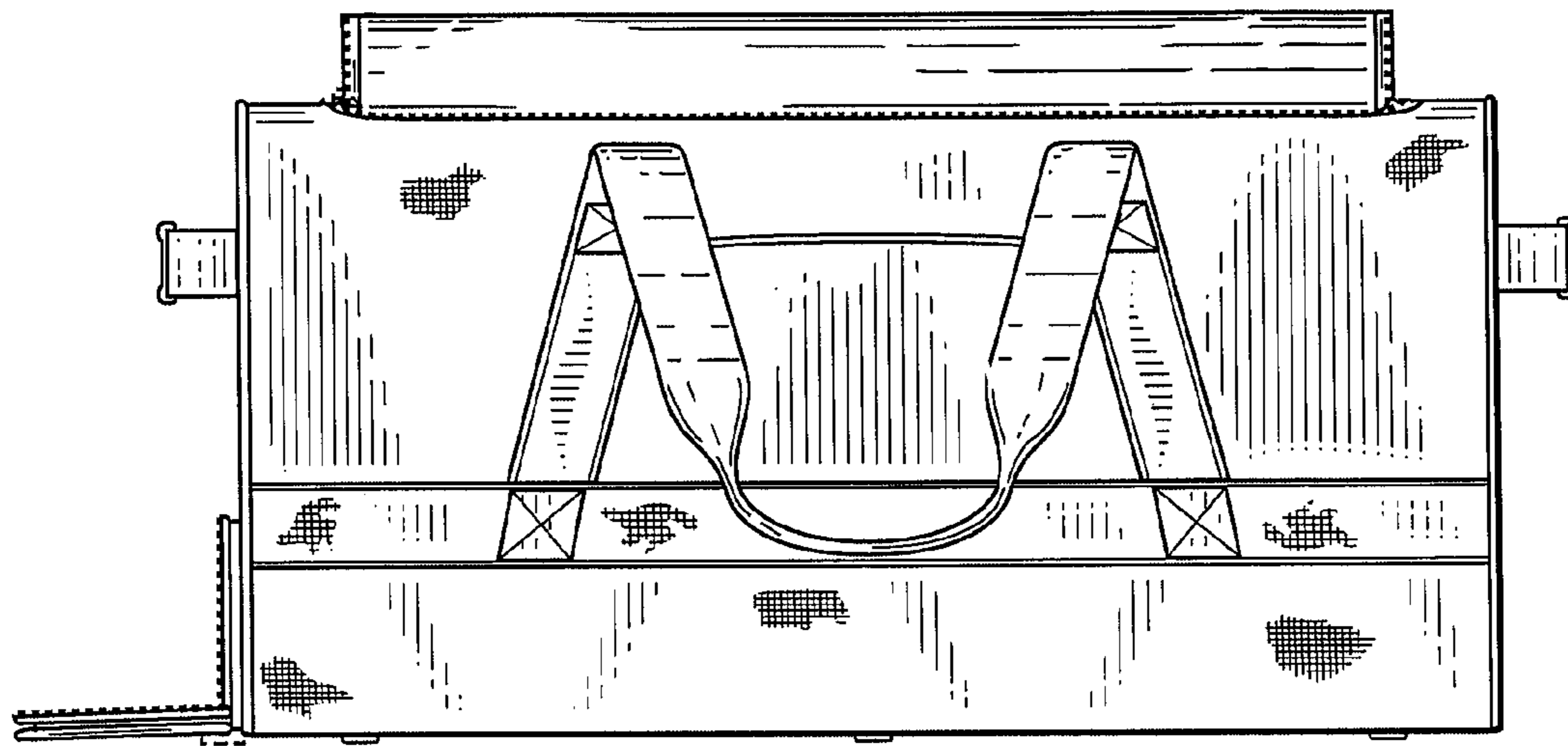

FIG. 9

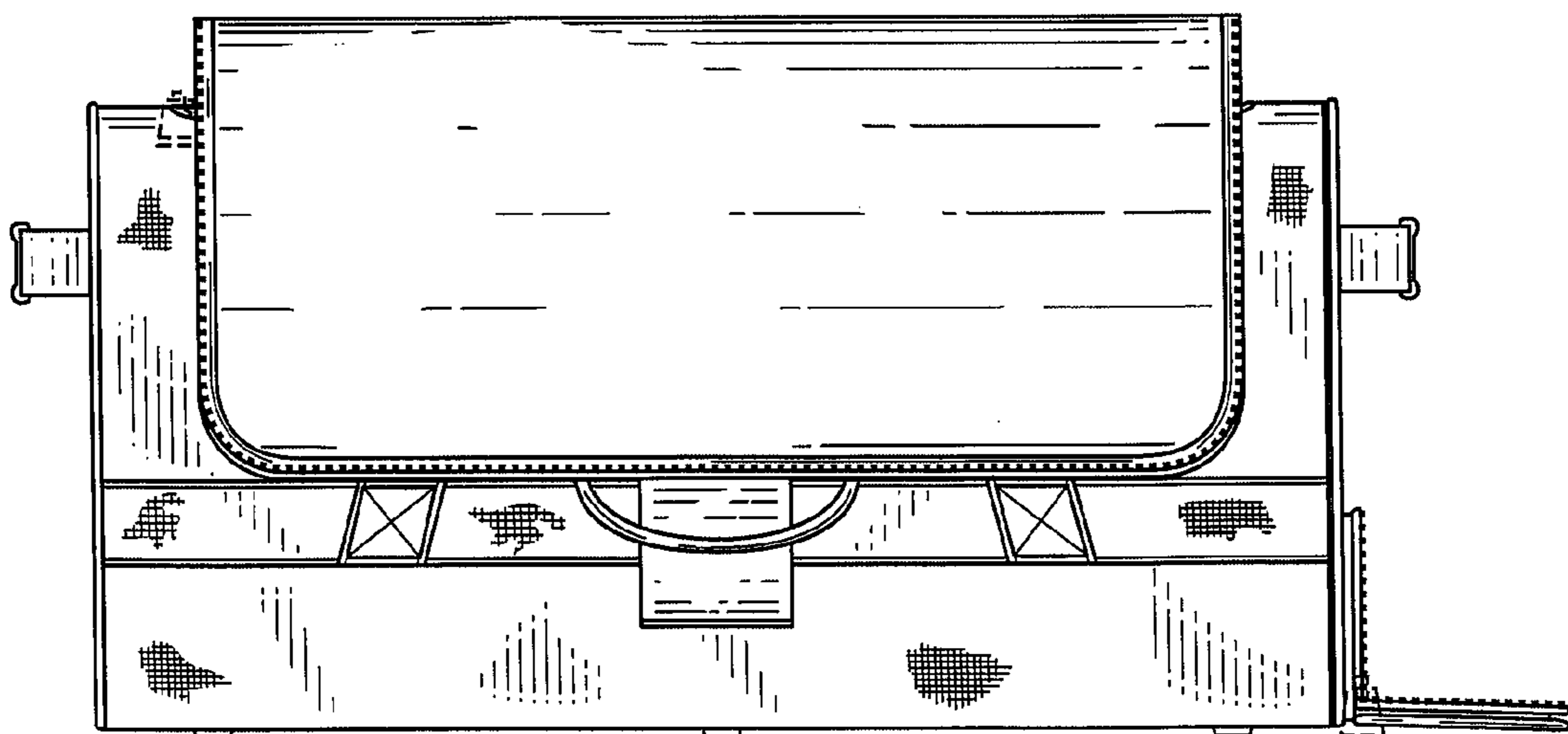

FIG. 10

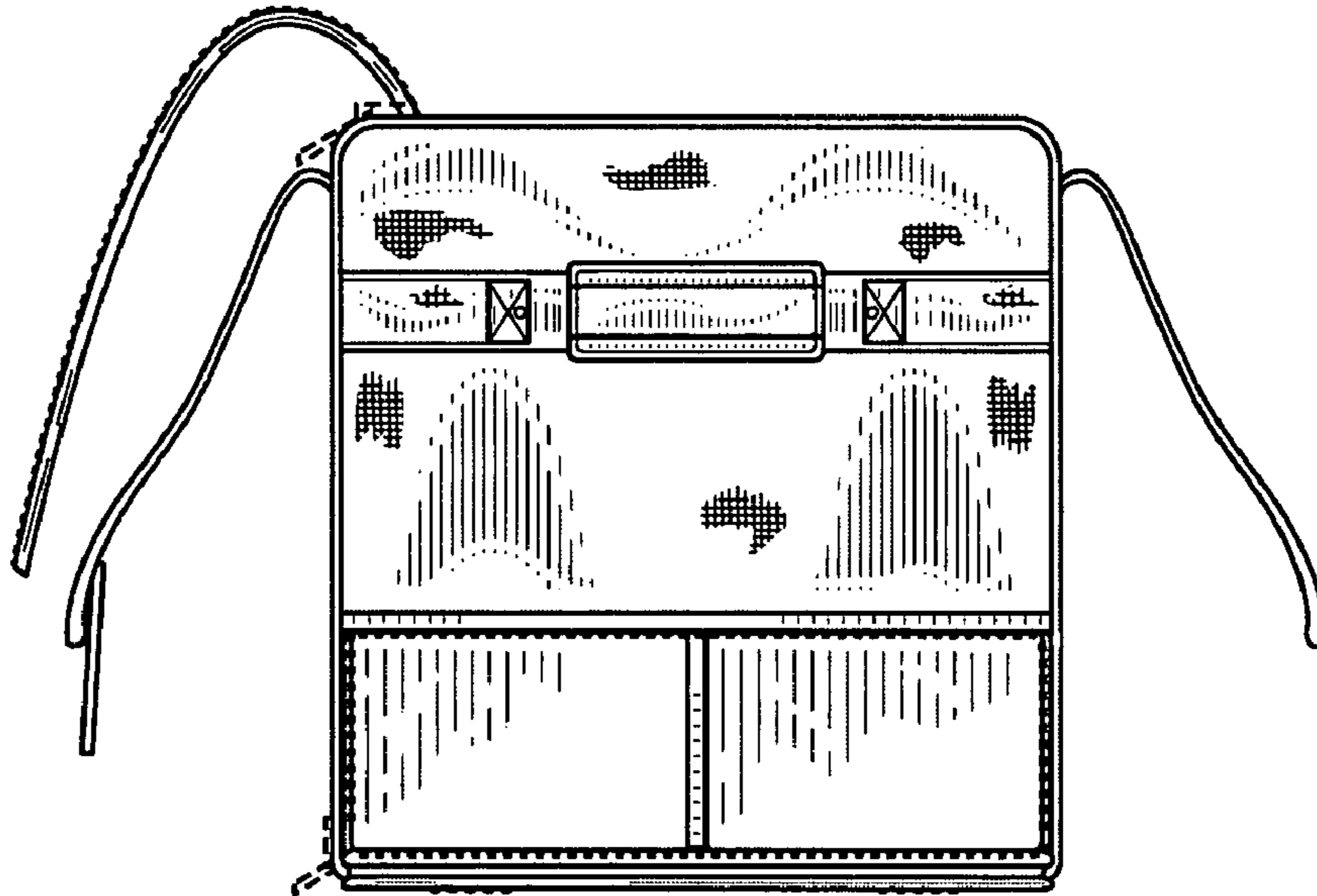

FIG. 11

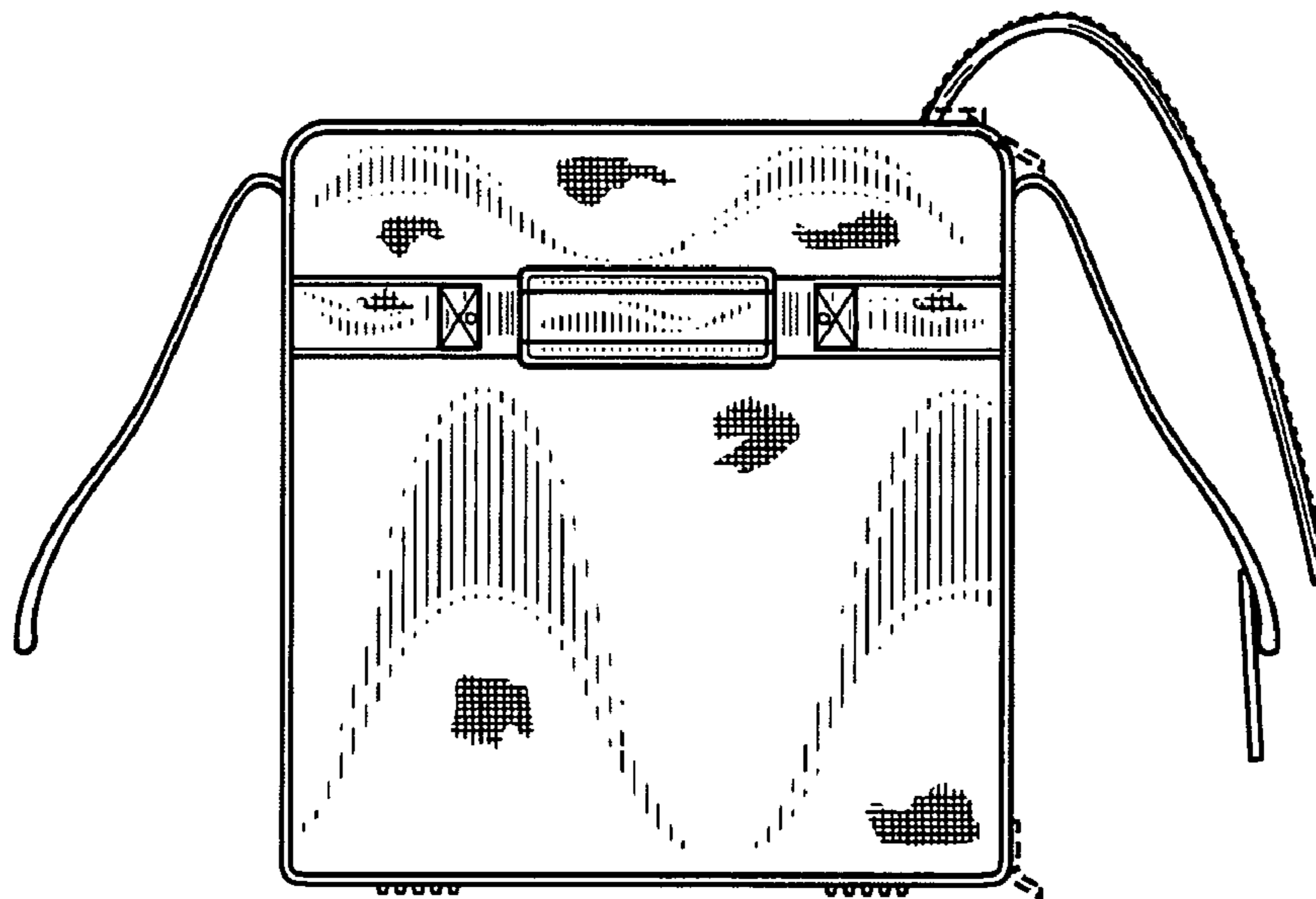

FIG. 12

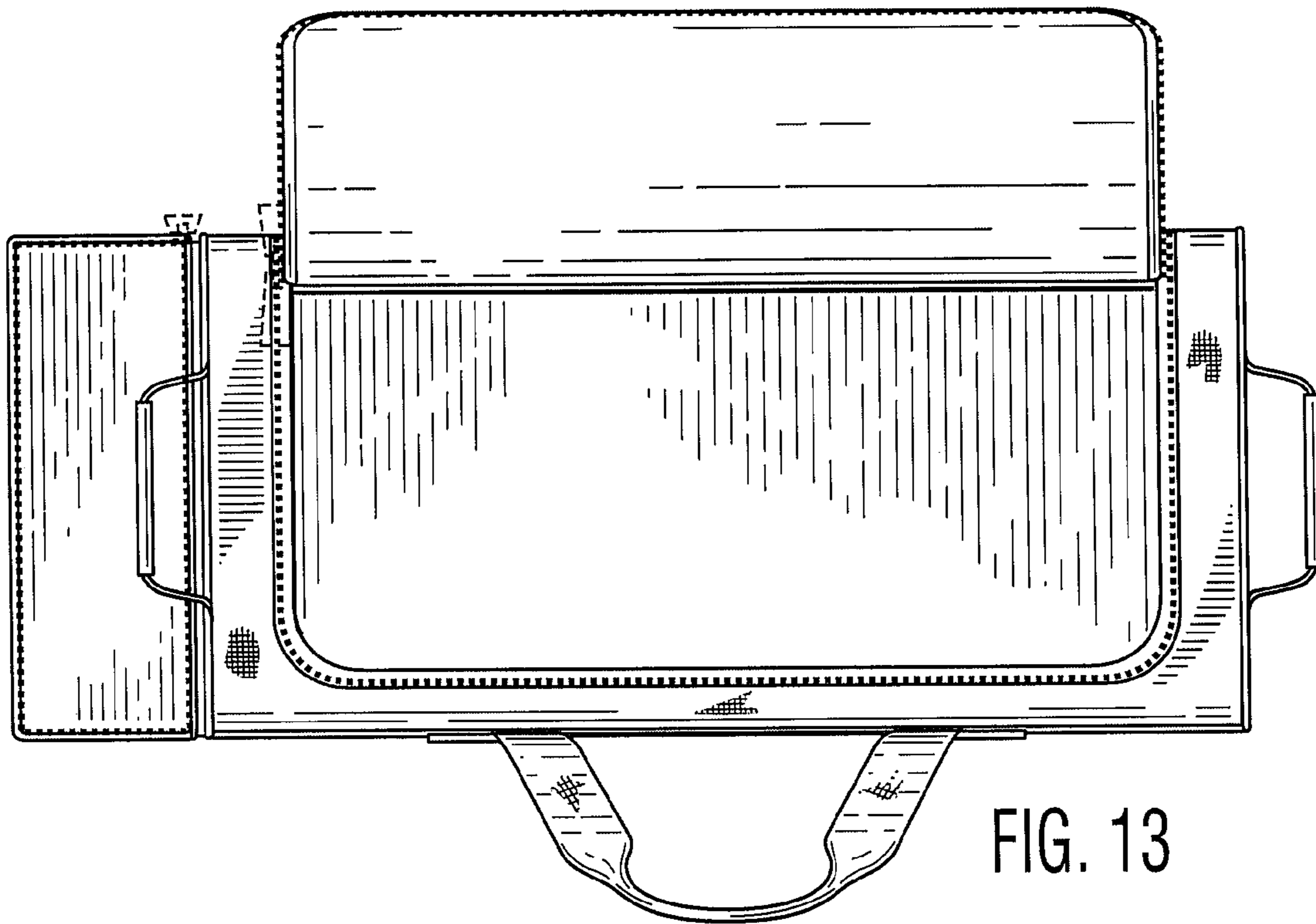

FIG. 13

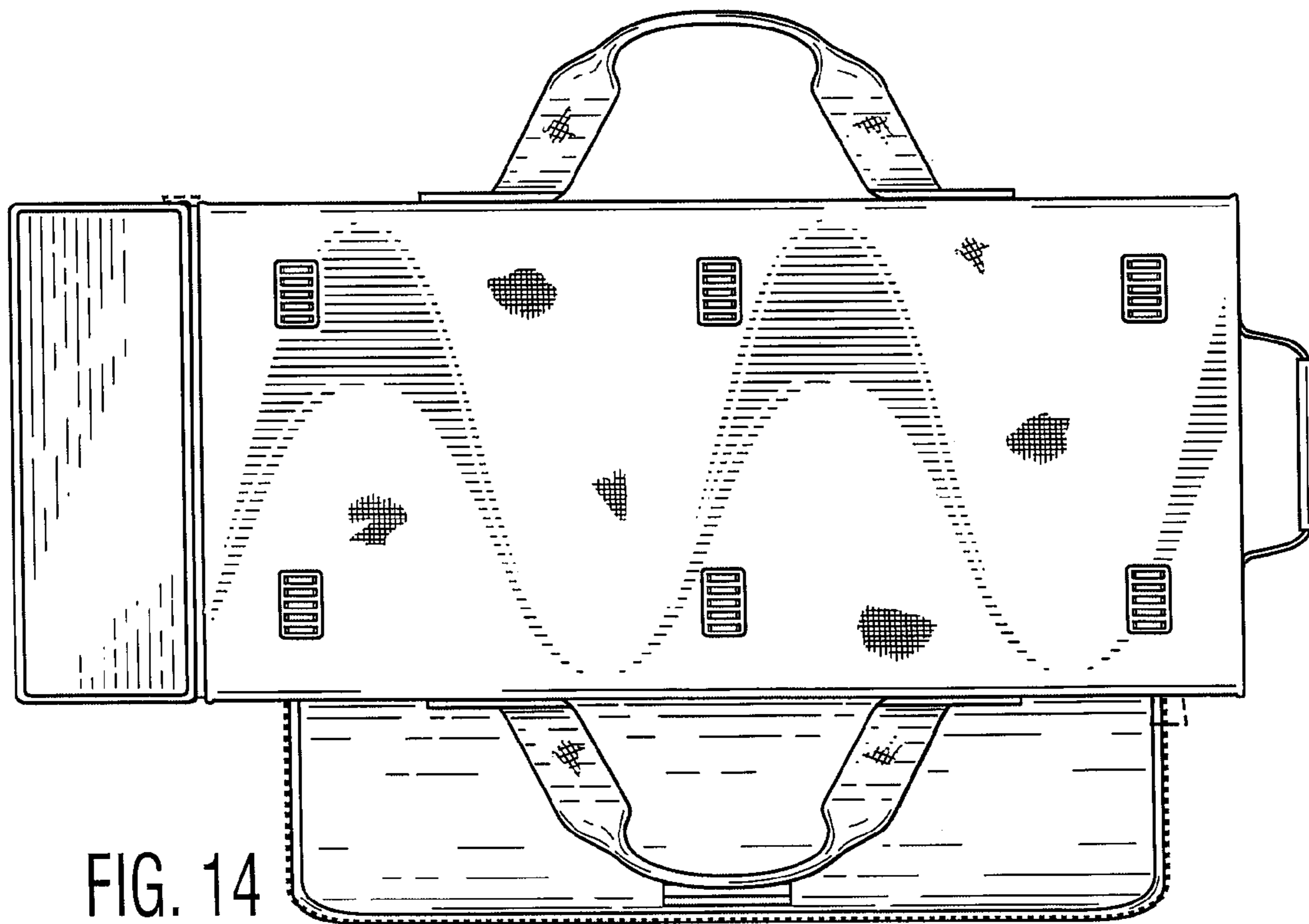

FIG. 14